

Accessories for manifolds C.O.

Nickel plated pipe union G3/4

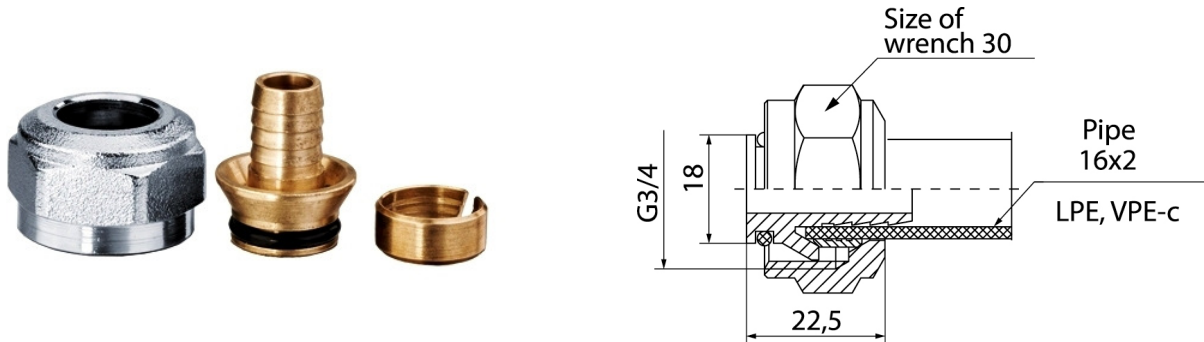

Code	Dimensions	EAN13
9006570	3/4"	5907451901779

Product usage:

For Pex/Al./Pex pipes in hot and cold water supplies and central heating systems

Type:

Accessories and spare parts

Guarantee:

25-year

Technical data/Operating parameters:

Max pressure: 1,0 MPa,
Max temperature: 90°C

Used materials:

nut, end piece, ring: brass;
sealing: O-ring seal, rubber NBR

Finish:

nut: nickel