

## ARMATURA SANITARNA





**VALVEX**<sup>TM</sup>  
Power of Quality

**VALVEX** jest znakiem zastrzeżonym Valvex S.A. i podlega ochronie prawnej. Wszelkie jego powielanie, kopiowanie lub używanie w jakikolwiek inny sposób bez zgody Valvex S.A. jest zabronione. Valvex S.A. zastrzega, że wygląd produktów przedstawionych na zdjęciach może nieznacznie odbiegać od wyglądu rzeczywistego produktów.

**ARMATURA SANITARNA**

## SYMBOLE

**25 lat gwarancji**  
Udzielamy 25-letniej gwarancji na elementy odlewane i kute.



### Serwis 48h

Gwarancja usługi serwisowej w 48h.

10 lat gwarancji



### Ekologia

Posiadamy ISO 14001, nasze technologie i produkty są przyjazne dla środowiska.

5 lat gwarancji



### Jakość

Posiadamy ISO 9001, nasze produkty wyróżniają się najwyższą jakością.

2 lata gwarancji



### Save Money

Rozwiązanie ograniczające zużycie wody.

Mieszacz / głowica ceramiczna



Regulowany rozstaw montażu

Regulator strumienia napowietrzający



Ultracienka głowica prysznicowa

Automatyczny korek spustowy Klik Clak



Śłuchawka 1-funkcyjna

Zespół spustowy z pociągaczem



Śłuchawka 3-funkcyjna

Niski przepływ



Śłuchawka 5-funkcyjna

Regulator strumienia z systemem antykamiennym



Strumień normalny

Przełącznik z blokadą



Strumień - masaż

Obrotowa wylewka



Strumień mieszany

Komfort użytkowania



Strumień musujący

Wyciągana wylewka



Strumień ekonomiczny

Cold touch



1l/min Soft STOP

Wąż natryskowy z systemem anti-twist



Bateria kompletna z zestawem natryskowym punktowym

Przełącznik ciśnieniowy



Elastyczna wylewka

Przełącznik ceramiczny



Regulowany kąt wypływu wody

System łatwego montażu



**KLASY PRZEPŁYWU WODY** Z - Poniżej 9l/min.

S - Poniżej 19,8l/min.

C - Poniżej 30l/min.

A - Poniżej 15l/min.

B - Poniżej 25,2l/min.

D - Poniżej 37,8l/min.

## SPIS TREŚCI

Cennik obowiązuje od 30.03.2020 na terenie Rzeczypospolitej Polskiej. Podane ceny są cenami netto.  
Data wydania: Marzec 2020

## GLAMOUR LINE 4

AURORA	MIKADO	6
AURORA ROSE GOLD	MIKADO	6
QUASAR	MIKADO	8
DALI	MIKADO	10
DALI WHITE	MIKADO	10
DALI BLACK	MIKADO	10
VEGANE		12
VEGANE BIANCO		12
VEGANE NERO		12
ELL	MIKADO	14
INIZIO		15

## SUBLIME LINE 16

LOFT, LOFT GOLD	18
LOFT BLACK, LOFT WHITE	18
TUBE	21
SIGMA	24
LORI	25
ANGELO	27
DELTA	29
FLEXI	29

## LIFE LINE 30

ECO	32
LOGIC	32
GALEO	35
CLASS	37

## BATERIE TERMOSTATYCZNE 40

ESTILL ROUND	41
ESTILL ROUND PLUS	41
ESTILL SQUARE PLUS	41

## ZESTAWY PODTYNKOWE 42

ROSE, DIONE,	44
CARRÉ, DESZCZOWNICE,	45
RAMIONA NATRYSKU,	47
PRZYŁĄCZA KĄTOWE,	48
WYLEWKI PODTYNKOWE	49

## ZESTAWY NATRYSKOWE 50

CUBUS BLACK, CUBUS,	52
DIYA BLACK, DIYA,	52
LOFT BLACK, LOFT,	53
TUBE,	53
FARO, COOL,	54
ROSE, LOFT GOLD,	55
WET, VERA,	55
FRESCO	55

## BATERIE SPECJALNE 56

MEDICA	58
SOLO	59
TIMEPRESS	59
URIVEX	59

## AKCESORIA 60

SŁUCHAWKI,	62
WĘŻE NATRYSKOWE,	66
DRAŻEK PRYSZNICOWY,	67
UCHWYTY PUNKTOWE,	68
KORKI SPUSTOWE,	69
WYLEWKI,	70
PERLATORY, GŁOWICE,	71
MIESZACZE,	72
PRZEŁĄCZNIKI NATRYSKU	72



GLAMOUR LINE

**1. AURORA**

Bateria umywalkowa stojąca z automatycznym korkiem spustowym

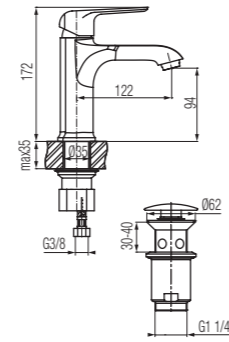

SAVE MONEY



Kod	Regulator	Klasa przepływu	Akcesoria	Wykończenie	Cena (PLN/szt.)
2445100	Ø35	Z	click-clack	Chrom	340,00
2445200				Rose Gold	518,00

**2. AURORA**

Bateria umywalkowa stojąca, wysoka

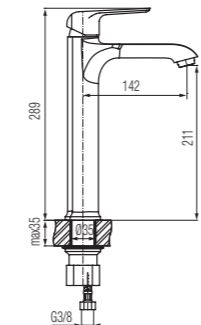

**AURORA**  
Rose Gold

**DESIGN**  
DLA KONESERA  
PIĘKNO INNOWACJA PRESTIŻ  
2018  
ZWYCIĘZCA

SAVE MONEY



Kod	Regulator	Klasa przepływu	Akcesoria	Wykończenie	Cena (PLN/szt.)
2445110	Ø35	Z	---	Chrom	415,00
2445117			Perlator MIKADO	Chrom	453,00
2445210			---	Rose Gold	677,00
2445217			Perlator MIKADO	Rose Gold	720,00

**3. AURORA**

Bateria wannowa ścienna

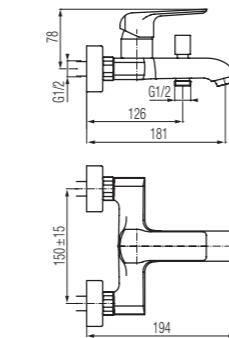

Kod	Regulator	Klasa przepływu	Akcesoria	Wykończenie	Cena (PLN/szt.)
2445130	Ø35	B/B	---	Chrom	318,00
2445230				Rose Gold	575,00

**4. AURORA**

Bateria natryskowa ścienna

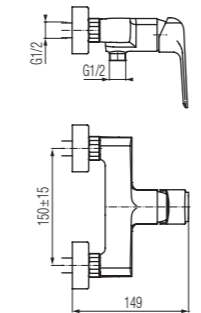

Kod	Regulator	Klasa przepływu	Akcesoria	Wykończenie	Cena (PLN/szt.)
2445140	Ø35	B	---	Chrom	245,00
2445240				Rose Gold	473,00

**5. AURORA**

Bateria wannowo-natryskowa podtynkowa

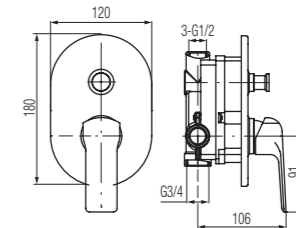

Kod	Regulator	Klasa przepływu	Akcesoria	Wykończenie	Cena (PLN/szt.)
2445170	Ø35	B/B	---	Chrom	409,00
2445270				Rose Gold	575,00

**6. AURORA**

Bateria natryskowa podtynkowa

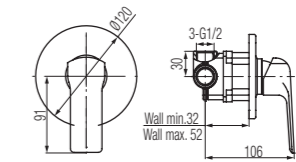

Kod	Regulator	Klasa przepływu	Akcesoria	Wykończenie	Cena (PLN/szt.)
2445160	Ø35	B	---	Chrom	276,00
2445260				Rose Gold	432,00

**7. AURORA**

Bateria bidetowa stojąca z korkiem spustowym

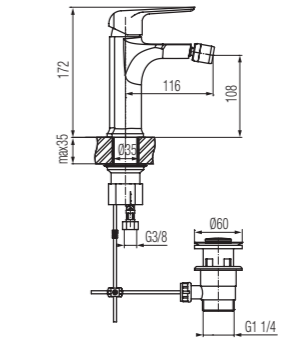

Kod	Regulator	Klasa przepływu	Akcesoria	Wykończenie	Cena (PLN/szt.)
2445120	Ø35	A	korek spustowy metalowy	Chrom	367,00
2445220				Rose Gold	575,00

**8. AURORA**

Bateria kuchenna stojąca z dźwignią z boku, z obrotową wylewką

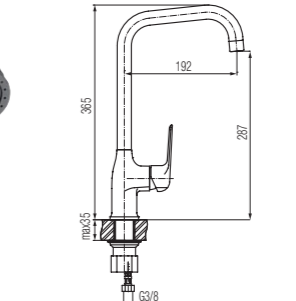

Kod	Regulator	Klasa przepływu	Akcesoria	Wykończenie	Cena (PLN/szt.)
2445150	Ø35	A	---	Chrom	354,00
2445157		Z	Perlator MIKADO	Chrom	391,00
2445250		A	---	Rose Gold	626,00
2445257		Z	Perlator MIKADO	Rose Gold	666,00

## 9. QUASAR

Bateria umywalkowa stojąca z automatycznym korkiem spustowym

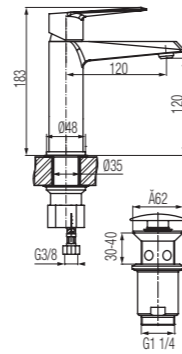

Kod	Regulator	Klasa przepływu	Akcesoria	Wykończenie	Cena (PLN/szt.)
2446800	Ø35	Z	click-clack	Chrom	369,00

## 10. QUASAR

Bateria umywalkowa stojąca, wysoka

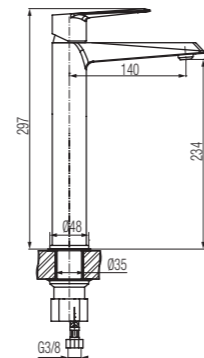

Kod	Regulator	Klasa przepływu	Akcesoria	Wykończenie	Cena (PLN/szt.)
2446810	Ø35	Z	---	Chrom	455,00
2446817	---	---	Perlator MIKADO	Chrom	492,00

## 11. QUASAR

Bateria wannowa ścienna

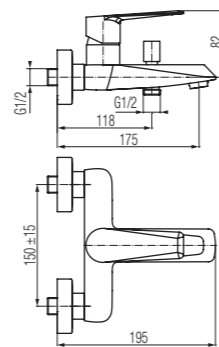

Kod	Regulator	Klasa przepływu	Akcesoria	Wykończenie	Cena (PLN/szt.)
2446830	Ø35	B/B	---	Chrom	404,00

## 12. QUASAR

Bateria natryskowa ścienna

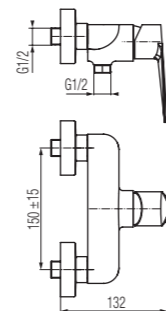

Kod	Regulator	Klasa przepływu	Akcesoria	Wykończenie	Cena (PLN/szt.)
2446840	Ø35	B	---	Chrom	283,00

## 13. QUASAR

Bateria wannowo-natryskowa podtynkowa

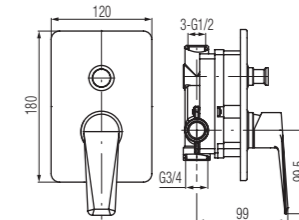

Kod	Regulator	Klasa przepływu	Akcesoria	Wykończenie	Cena (PLN/szt.)
2446870	Ø35	B/B	---	Chrom	411,00

## 14. QUASAR

Bateria natryskowa podtynkowa

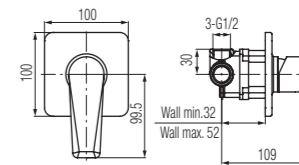

Kod	Regulator	Klasa przepływu	Akcesoria	Wykończenie	Cena (PLN/szt.)
2446860	Ø35	B	---	Chrom	278,00

## 15. QUASAR

Bateria bidetowa stojąca z korkiem spustowym

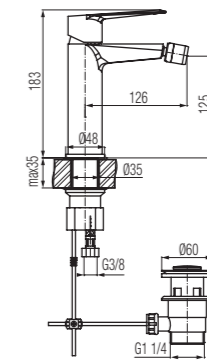

Kod	Regulator	Klasa przepływu	Akcesoria	Wykończenie	Cena (PLN/szt.)
2446820	Ø35	A	korek spustowy metalowy	Chrom	431,00

## 16. QUASAR

Bateria kuchenna stojąca z dźwignią z boku, z obrotową wylewką

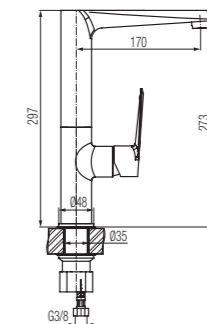

Kod	Regulator	Klasa przepływu	Akcesoria	Wykończenie	Cena (PLN/szt.)
2446850	Ø35	A	---	Chrom	553,00
2446857	---	Z	Perlator MIKADO	Chrom	591,00

finalista konkursu  
**DOBRY WZÓR**  
 2018

## 17. DALI

Bateria umywalkowa stojąca z automatycznym korkiem spustowym

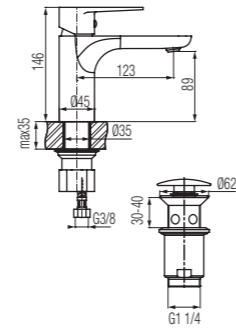

SAVE MONEY

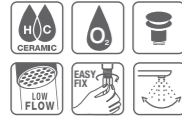

Kod	Regulator	Klasa przepływu	Akcesoria	Wykończenie	Cena (PLN/szt.)
2447200				● Chrom	302,00
2447300	035	Z	click-clack	● White / Chrom	336,00
2447900				● Black / Chrom	358,00

## 18. DALI

Bateria umywalkowa stojąca, wysoka

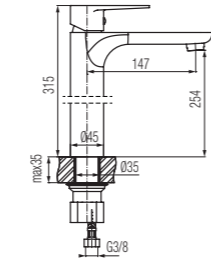

SAVE MONEY



Kod	Regulator	Klasa przepływu	Akcesoria	Wykończenie	Cena (PLN/szt.)
2447210			---	● Chrom	414,00
2447217			Perlator MIKADO	● Chrom	448,00
2447310	035	Z	---	● White / Chrom	448,00
2447317			Perlator MIKADO	● White / Chrom	481,00
2447910			---	● Black / Chrom	470,00
2447917			Perlator MIKADO	● Black / Chrom	504,00

## 19. DALI

Bateria wannowa ścienna

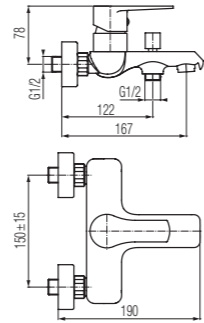

Kod	Regulator	Klasa przepływu	Akcesoria	Wykończenie	Cena (PLN/szt.)
2447230				● Chrom	336,00
2447330	035	B/B	---	● White / Chrom	369,00
2447930				● Black / Chrom	392,00

## 20. DALI

Bateria natryskowa ścienna

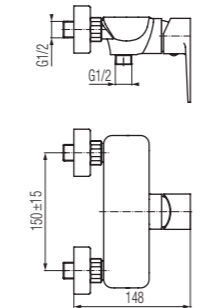

Kod	Regulator	Klasa przepływu	Akcesoria	Wykończenie	Cena (PLN/szt.)
2447240				● Chrom	268,00
2447340	035	B	---	● White / Chrom	302,00
2447940				● Black / Chrom	325,00

## 21. DALI

Bateria wannowo-natryskowa podtynkowa

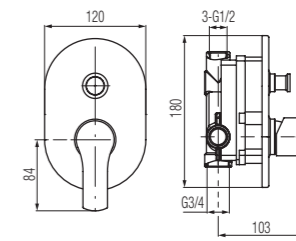

Kod	Regulator	Klasa przepływu	Akcesoria	Wykończenie	Cena (PLN/szt.)
2447270				● Chrom	374,00
2447370	035	B/B	---	● White / Chrom	414,00
2447970				● Black / Chrom	414,00

## 22. DALI

Bateria natryskowa podtynkowa

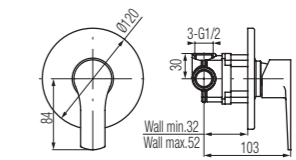

Kod	Regulator	Klasa przepływu	Akcesoria	Wykończenie	Cena (PLN/szt.)
2447260				● Chrom	253,00
2447360	035	B	---	● White / Chrom	280,00
2447960				● Black / Chrom	280,00

## 23. DALI

Bateria bidetowa stojąca z korkiem spustowym

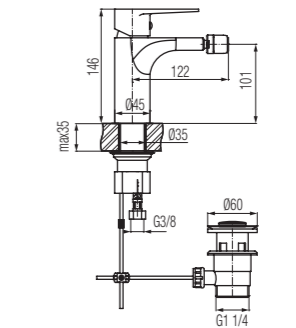

Kod	Regulator	Klasa przepływu	Akcesoria	Wykończenie	Cena (PLN/szt.)
2447220				● Chrom	336,00
2447320	035	A	korek spustowy metalowy	● White / Chrom	369,00
2447920				● Black / Chrom	392,00

## 24. DALI

Bateria kuchenna stojąca z dźwignią z boku, z obrotową wylewką

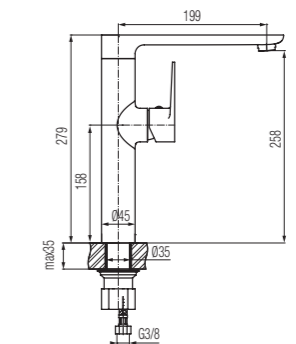

Kod	Regulator	Klasa przepływu	Akcesoria	Wykończenie	Cena (PLN/szt.)
2447250				● Chrom	448,00
2447350	035	Z	---	● White / Chrom	515,00
2447950				● Black / Chrom	527,00

## 25. VEGANE

Bateria umywalkowa stojąca z korkiem spustowym

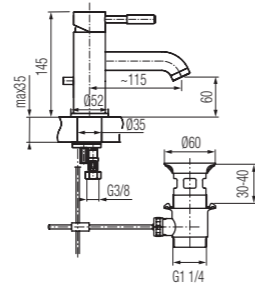

SAVE MONEY



Kod	Regulator	Klasa przepływu	Akcesoria	Wykończenie	Cena (PLN/szt.)
2422750				● Chrom	456,00
2423300	Ø35	Z	korek spustowy metalowy	● White	605,00
2423310				● Black	605,00

## 26. VEGANE

Bateria umywalkowa wysoka, stojąca z automatycznym korkiem spustowym

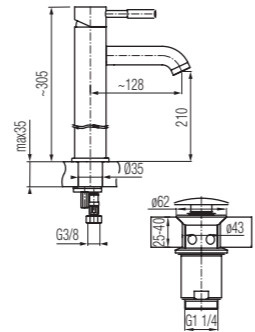

SAVE MONEY



Kod	Regulator	Klasa przepływu	Akcesoria	Wykończenie	Cena (PLN/szt.)
2422770				● Chrom	603,00
2423320	Ø35	Z	click-clack	● White	809,00
2423330				● Black	809,00

## 27. VEGANE

Bateria umywalkowa 3-otworowa stojąca z korkiem spustowym, z obrotową wylewką

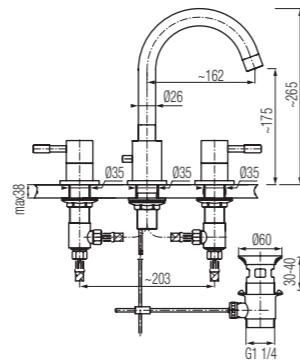

Kod	Regulator	Klasa przepływu	Akcesoria	Wykończenie	Cena (PLN/szt.)
2422790	głowica ceramiczna	A	korek spustowy metalowy	● Chrom	926,00

## 28. VEGANE

Bateria umywalkowa 3-otworowa podtynkowa

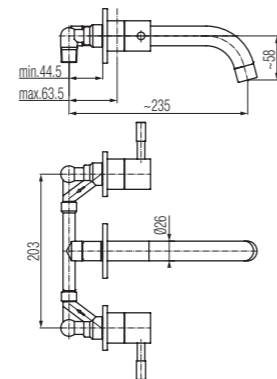

Kod	Regulator	Klasa przepływu	Akcesoria	Wykończenie	Cena (PLN/szt.)
2422810	Ø35	A	---	● Chrom	660,00

## 29. VEGANE

Bateria wannowa 5-otworowa stojąca z obrotową wylewką, z akcesoriami

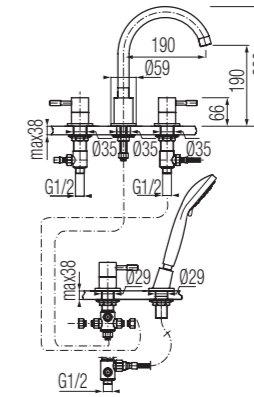

Kod	Regulator	Klasa przepływu	Akcesoria	Wykończenie	Cena (PLN/szt.)
2422830	głowica ceramiczna	B/A	śluchawka, wąż natryskowy 1500 mm	● Chrom	1 420,00

## 30. VEGANE

Bateria wannowa ścienna z akcesoriami

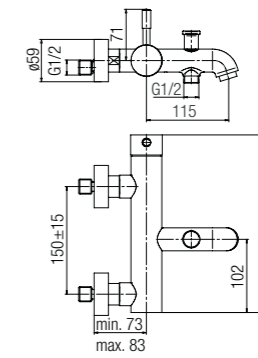

Kod	Regulator	Klasa przepływu	Akcesoria	Wykończenie	Cena (PLN/szt.)
2422890				● Chrom	862,00
2423380	Ø35	S/A	śluchawka, uchwyt punktowy, wąż natryskowy 1500 mm	● White	1 083,00
2423390				● Black	1 083,00

## 31. VEGANE

Bateria natryskowa ścienna z akcesoriami

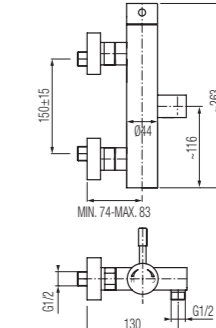

Kod	Regulator	Klasa przepływu	Akcesoria	Wykończenie	Cena (PLN/szt.)
2422870				● Chrom	802,00
2423360	Ø35	A	śluchawka, uchwyt punktowy, wąż natryskowy 1500 mm	● White	984,00
2423370				● Black	984,00

## 32. VEGANE

Bateria bidetowa stojąca z korkiem spustowym

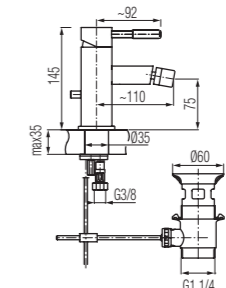

Kod	Regulator	Klasa przepływu	Akcesoria	Wykończenie	Cena (PLN/szt.)
2422850				● Chrom	511,00
2423340	Ø35	A	korek spustowy metalowy	● White	692,00
2423350				● Black	692,00



**33. VEGANE**

Bateria kuchenna stojąca z wyciąganym natraskiem, z obrotową wylewką

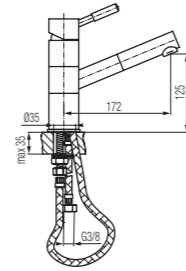

Kod	Regulator	Klasa przepływu	Aksesoria	Wykończenie	Cena (PLN/szt.)
2451650	Ø40	A	---	● Chrom	<b>622,00</b>
2451660				● White	<b>746,00</b>
2451670				● Black	<b>746,00</b>

**34. VEGANE**

Bateria kuchenna stojąca z dźwignią z boku, z obrotową wylewką

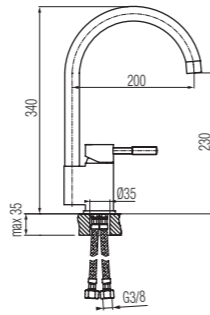

Kod	Regulator	Klasa przepływu	Aksesoria	Wykończenie	Cena (PLN/szt.)
2451550	Ø40	A	---	● Chrom	<b>477,00</b>

**35. VEGANE**

Bateria kuchenna stojąca, teleskopowa, z obrotową wylewką

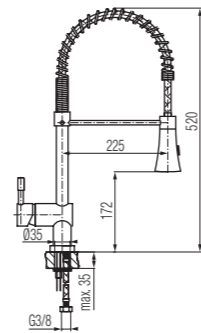

Kod	Regulator	Klasa przepływu	Aksesoria	Wykończenie	Cena (PLN/szt.)
2451600	Ø40	A	---	● Chrom	<b>779,00</b>

**36. ELL**

Bateria kuchenna stojąca z dźwignią z boku, z obrotową wylewką

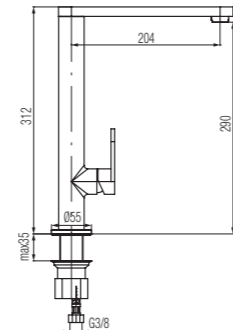

Kod	Regulator	Klasa przepływu	Aksesoria	Wykończenie	Cena (PLN/szt.)
2453720	Ø35	A	---	● Chrom	<b>420,00</b>
2453727		Z	Perlator MIKADO	● Chrom	<b>455,00</b>

**37. INIZIO**

Bateria kuchenna stojąca, teleskopowa, z obrotową wylewką

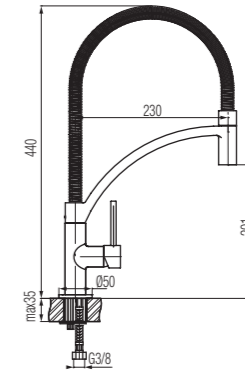

Kod	Regulator	Klasa przepływu	Aksesoria	Wykończenie	Cena (PLN/szt.)
2425900	Ø25	Z	---	● Chrom	<b>562,00</b>



SUBLIME LINE

**1. LOFT ECO**

Bateria umywalkowa stojąca z automatycznym korkiem spustowym

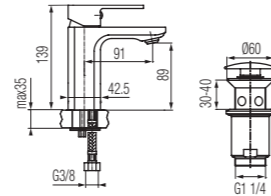

Kod	Regulator	Klasa przepływu	Akcesoria	Wykończenie	Cena (PLN/szt.)
2454900	Ø35	Z	click-clack	Chrom	333,00
2455800	Ø35	Z	click-clack	Gold	471,00
2455900	Ø35	Z	click-clack	Black	355,00
2456500	Ø35	Z	click-clack	White/Chrome	376,00

**2. LOFT**

Bateria umywalkowa stojąca z automatycznym korkiem spustowym

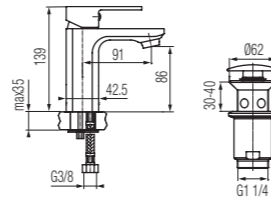

Kod	Regulator	Klasa przepływu	Akcesoria	Wykończenie	Cena (PLN/szt.)
2454910	Ø35	A	click-clack	Chrom	294,00

**3. LOFT**

Bateria umywalkowa stojąca (wys. 239 mm)

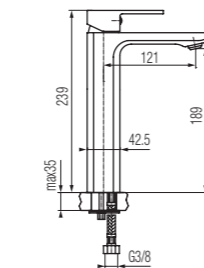

Kod	Regulator	Klasa przepływu	Akcesoria	Wykończenie	Cena (PLN/szt.)
2454920	Ø35	Z	---	Chrom	431,00

**4. LOFT**

Bateria umywalkowa stojąca wysoka (wys. 270 mm)

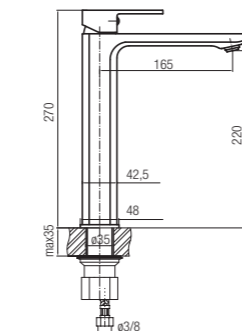

Kod	Regulator	Klasa przepływu	Akcesoria	Wykończenie	Cena (PLN/szt.)
2454730	Ø35	Z	---	Chrom	447,00
2455910	Ø35	Z	---	Black	492,00
2456510	Ø35	Z	---	White/Chrome	513,00

**5. LOFT**

Bateria umywalkowa ścienna, podtynkowa z wylewką

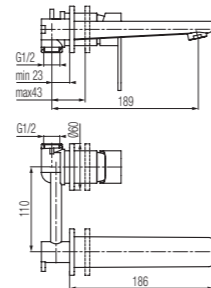

Kod	Regulator	Klasa przepływu	Akcesoria	Wykończenie	Cena (PLN/szt.)
2454780	Ø35	A	---	Chrom	435,00

**6. LOFT**

Bateria wannowa 4-otworowa stojąca z akcesoriami

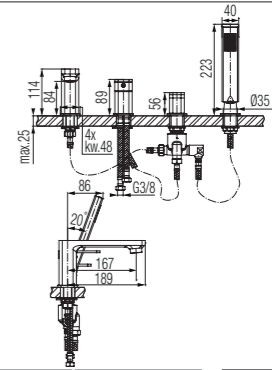

Kod	Regulator	Kl. przepływu	Akcesoria	Wykończenie	Cena (PLN/szt.)
2454890	gl. ceramiczna	B/Z	sluchawka, wąż natryskowy 1500 mm	Chrom	905,00
2455950	gl. ceramiczna	B/Z	sluchawka, wąż natryskowy 1500 mm	Black	981,00
2456550	gl. ceramiczna	B/Z	sluchawka, wąż natryskowy 1500 mm	White/Chrom	1 037,00

**7. LOFT**

Bateria wannowa ścienna

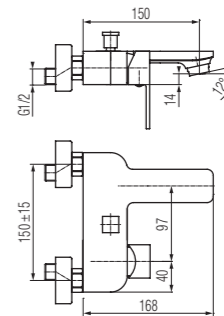

Kod	Regulator	Klasa przepływu	Akcesoria	Wykończenie	Cena (PLN/szt.)
2454930	Ø35	B/B	---	Chrom	378,00
2455810	Ø35	B/B	---	Gold	657,00
2455920	Ø35	B/B	---	Black	413,00
2456520	Ø35	B/B	---	White/Chrom	436,00

**8. LOFT**

Bateria natryskowa ścienna

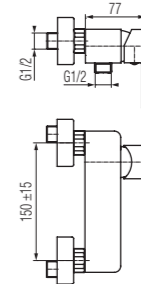

Kod	Regulator	Klasa przepływu	Akcesoria	Wykończenie	Cena (PLN/szt.)
2454940	Ø35	B	---	Chrom	293,00
2455820	Ø35	B	---	Gold	438,00
2455930	Ø35	B	---	Black	321,00
2456530	Ø35	B	---	White/Chrom	334,00

**9. LOFT**

Bateria natryskowa 2-funkcyjna z przyłączem górnym

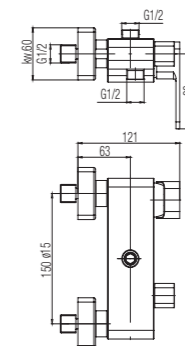

Kod	Regulator	Klasa przepływu	Akcesoria	Wykończenie	Cena (PLN/szt.)
2455760	Ø35	B/B	---	Chrom	382,00

SUBLIME LINE

25 YEARS GUARANTEE  
48h SERVICE

SUBLIME LINE

25 YEARS GUARANTEE  
48h SERVICE

## 10. LOFT

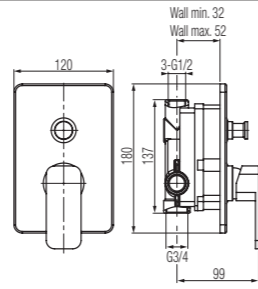
Bateria wannowo-natryskowa  
podtynkowa

Kod	Regulator	Klasa przepływu	Aksesoria	Wykończenie	Cena (PLN/szt.)
2454980	Ø35	B/B	---	Chrom	406,00
2455970	Ø35	B/B	---	Black	446,00
2456570	Ø35	B/B	---	White/Chrom	468,00

## 11. LOFT

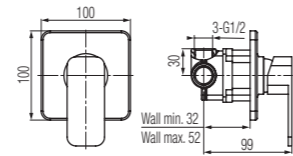
Bateria natryskowa  
podtynkowa

Kod	Regulator	Klasa przepływu	Aksesoria	Wykończenie	Cena (PLN/szt.)
2454970	Ø35	B	---	Chrom	275,00
2455960	Ø35	B	---	Black	303,00
2456560	Ø35	B	---	White/Chrom	313,00

## 12. LOFT

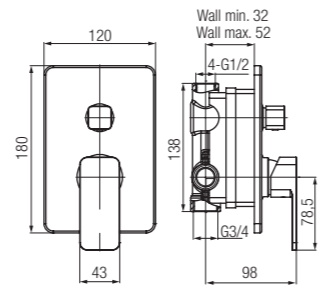
Bateria podtynkowa z przełącznikiem  
ceramicznym 3-funkcyjnym

Kod	Regulator	Klasa przepływu	Aksesoria	Wykończenie	Cena (PLN/szt.)
2408660	Ø35	B/B/B	---	Chrom	566,00

## 13. LOFT

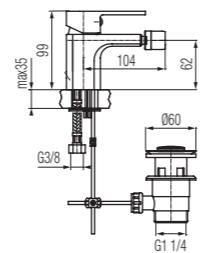
Bateria bidetowa  
stojąca z korkiem spustowym

Kod	Regulator	Klasa przepływu	Aksesoria	Wykończenie	Cena (PLN/szt.)
2454950	Ø35	Z	korek spustowy metalowy	Chrom	336,00
2455940	Ø35	Z	korek spustowy metalowy	Black	366,00
2456540	Ø35	Z	korek spustowy metalowy	White/Chrom	387,00

## 14. LOFT

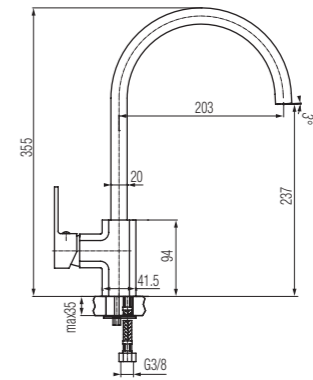
Bateria kuchenna  
stojąca z dźwignią z boku,  
z obrotową wylewką

Kod	Regulator	Klasa przepływu	Aksesoria	Wykończenie	Cena (PLN/szt.)
2454960	Ø35	A	---	Chrom	378,00

## 15. TUBE ECO

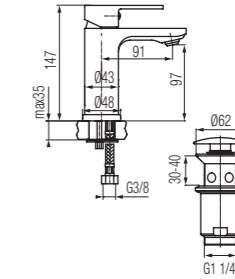
Bateria umywalkowa  
stojąca z automatycznym korkiem spustowym

Kod	Regulator	Klasa przepływu	Aksesoria	Wykończenie	Cena (PLN/szt.)
2454800	Ø35	Z	click-clack	Chrom	306,00

## 16. TUBE

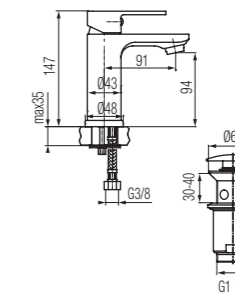
Bateria umywalkowa  
stojąca z automatycznym korkiem spustowym

Kod	Regulator	Klasa przepływu	Aksesoria	Wykończenie	Cena (PLN/szt.)
2454810	Ø35	A	click-clack	Chrom	278,00

## 17. TUBE

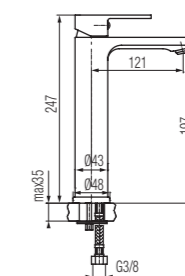
Bateria umywalkowa  
stojąca, wysoka

Kod	Regulator	Klasa przepływu	Aksesoria	Wykończenie	Cena (PLN/szt.)
2454820	Ø35	Z	---	Chrom	401,00

## 18. TUBE

Bateria umywalkowa  
naścienna, podtynkowa z wylewką

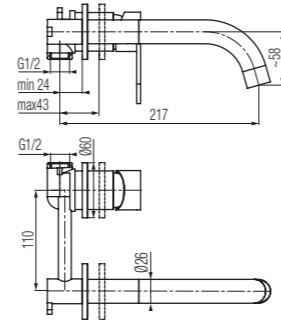

Kod	Regulator	Klasa przepływu	Akcesoria	Wykończenie	Cena (PLN/szt.)
2454790	Ø35	A	---	Chrom	430,00

## 19. TUBE

Bateria wannowa  
ścienna

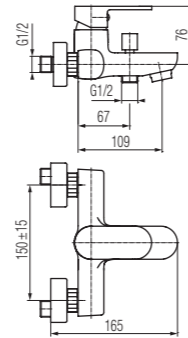

Kod	Regulator	Klasa przepływu	Akcesoria	Wykończenie	Cena (PLN/szt.)
2454830	Ø35	B/B	---	Chrom	372,00

## 20. TUBE

Bateria natryskowa  
ścienna

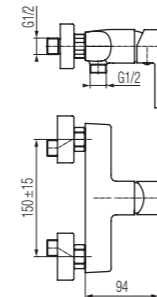

Kod	Regulator	Klasa przepływu	Akcesoria	Wykończenie	Cena (PLN/szt.)
2454840	Ø35	B	---	Chrom	278,00

## 21. TUBE

Bateria natryskowa 2-funkcyjna  
z przyłączem górnym

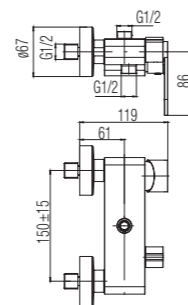

Kod	Regulator	Klasa przepływu	Akcesoria	Wykończenie	Cena (PLN/szt.)
2455720	Ø35	B/B	---	Chrom	392,00

## 22. TUBE

Bateria wannowo-natryskowa  
podtynkowa

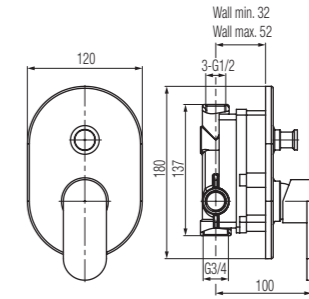

Kod	Regulator	Klasa przepływu	Akcesoria	Wykończenie	Cena (PLN/szt.)
2454880	Ø35	B/B	---	Chrom	403,00

## 23. TUBE

Bateria natryskowa  
podtynkowa

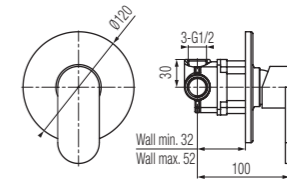

Kod	Regulator	Klasa przepływu	Akcesoria	Wykończenie	Cena (PLN/szt.)
2454870	Ø35	B	---	Chrom	264,00

## 24. TUBE

Bateria podtynkowa z przełącznikiem  
ceramicznym 3-funkcyjnym

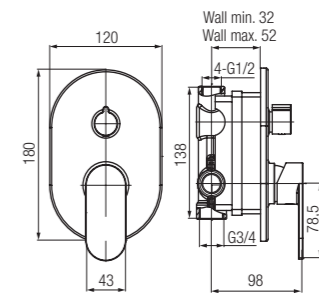

Kod	Regulator	Klasa przepływu	Akcesoria	Wykończenie	Cena (PLN/szt.)
2408640	Ø35	B/B/B	---	Chrom	547,00

## 25. TUBE

Bateria bidetowa  
stojąca z korkiem spustowym

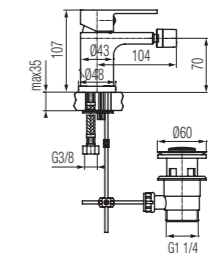

Kod	Regulator	Klasa przepływu	Akcesoria	Wykończenie	Cena (PLN/szt.)
2454850	Ø35	Z	korek spustowy metalowy	Chrom	315,00

## 26. TUBE

Bateria kuchenna  
stojąca z dźwignią z boku,  
z obrotową wylewką

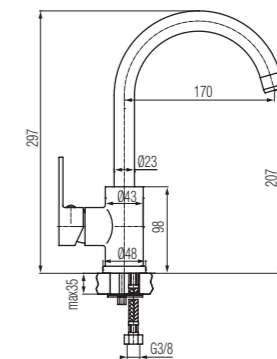

Kod	Regulator	Klasa przepływu	Akcesoria	Wykończenie	Cena (PLN/szt.)
2454860	Ø35	Z	---	Chrom	334,00

**27. SIGMA**

Bateria umywalkowa stojąca z automatycznym korkiem spustowym

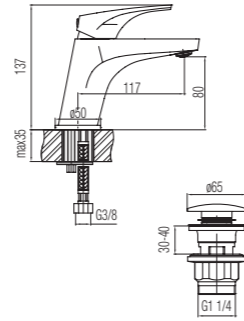

SAVE MONEY



Kod	Regulator	Klasa przepływu	Akcesoria	Wykończenie	Cena (PLN/szt.)
2456100	Ø35	Z	click-clack	Chrom	220,00

**28. SIGMA**

Bateria umywalkowa wysoka, stojąca z automatycznym korkiem spustowym

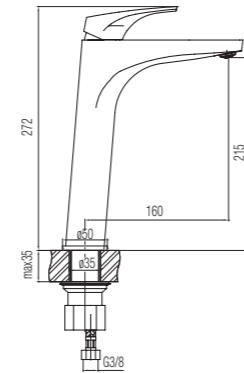

SAVE MONEY



Kod	Regulator	Klasa przepływu	Akcesoria	Wykończenie	Cena (PLN/szt.)
2456140	Ø35	Z	---	Chrom	417,00

**29. SIGMA**

Bateria wannowa ścienna

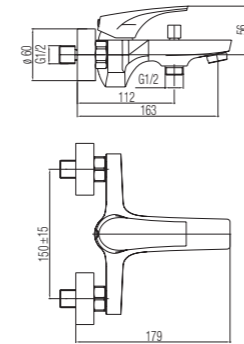

Kod	Regulator	Klasa przepływu	Akcesoria	Wykończenie	Cena (PLN/szt.)
2456110	Ø35	A/B	---	Chrom	326,00

**30. SIGMA**

Bateria natryskowa ścienna

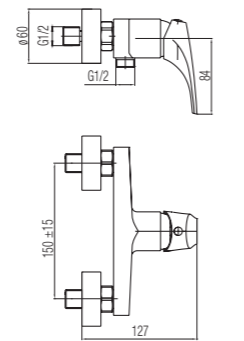

Kod	Regulator	Klasa przepływu	Akcesoria	Wykończenie	Cena (PLN/szt.)
2456120	Ø35	B	---	Chrom	230,00

**31. SIGMA**

Bateria natryskowa podtynkowa

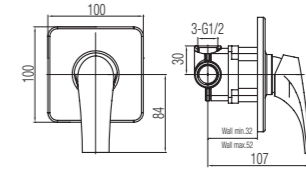

Kod	Regulator	Klasa przepływu	Akcesoria	Wykończenie	Cena (PLN/szt.)
2456160	Ø35	B	---	Chrom	274,00

**32. SIGMA**

Bateria wannowo-natryskowa podtynkowa

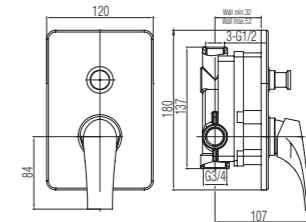

Kod	Regulator	Klasa przepływu	Akcesoria	Wykończenie	Cena (PLN/szt.)
2456170	Ø35	B/B	---	Chrom	407,00

**33. LORI**

Bateria umywalkowa stojąca z automatycznym korkiem spustowym

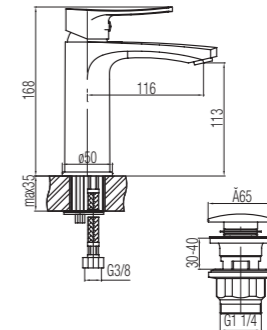

SAVE MONEY



Kod	Regulator	Klasa przepływu	Akcesoria	Wykończenie	Cena (PLN/szt.)
2456200	Ø35	Z	click-clack	Chrom	241,00

**34. LORI**

Bateria umywalkowa wysoka, stojąca z automatycznym korkiem spustowym

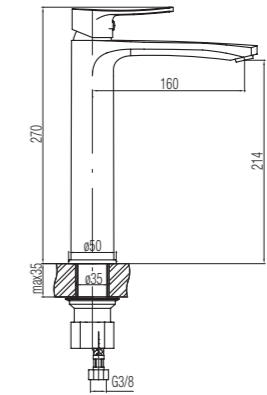

SAVE MONEY



Kod	Regulator	Klasa przepływu	Akcesoria	Wykończenie	Cena (PLN/szt.)
2456240	Ø35	Z	---	Chrom	429,00

## 35. LORI

Bateria wannowa ścienna

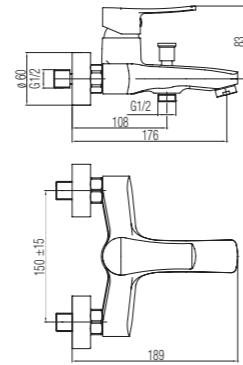

Kod	Regulator	Klasa przepływu	Aksesoria	Wykończenie	Cena (PLN/szt.)
2456210	Ø35	A/B	---	Chrom	318,00

## 36. LORI

Bateria natryskowa ścienna

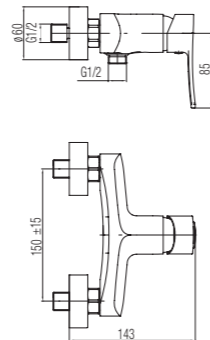

Kod	Regulator	Klasa przepływu	Aksesoria	Wykończenie	Cena (PLN/szt.)
2456220	Ø35	B	---	Chrom	230,00

## 37. LORI

Bateria natryskowa podtynkowa

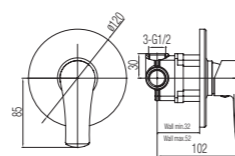

Kod	Regulator	Klasa przepływu	Aksesoria	Wykończenie	Cena (PLN/szt.)
2456250	Ø35	B	---	Chrom	258,00

## 38. LORI

Bateria wannowo-natryskowa podtynkowa

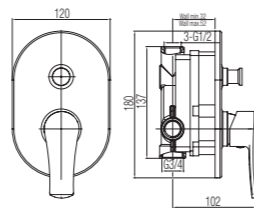

Kod	Regulator	Klasa przepływu	Aksesoria	Wykończenie	Cena (PLN/szt.)
2456260	Ø35	B/B	---	Chrom	377,00

## 39. ANGELO

Bateria umywalkowa stojąca z korkiem spustowym

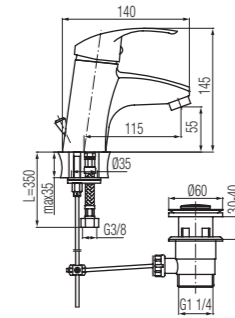

Kod	Regulator	Klasa przepływu	Aksesoria	Wykończenie	Cena (PLN/szt.)
2453000	Ø40	S	korek spustowy metalowy	Chrom	303,00

## 40. ANGELO

Bateria wannowa ścienna

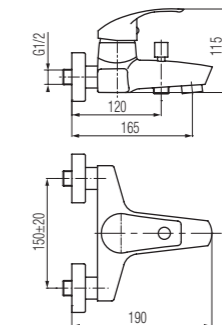

Kod	Regulator	Klasa przepływu	Aksesoria	Wykończenie	Cena (PLN/szt.)
2453010	Ø40	B/B	---	Chrom	347,00

## 41. ANGELO

Bateria natryskowa ścienna

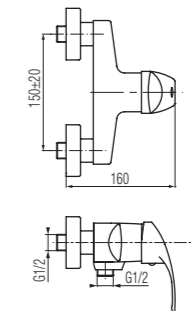

Kod	Regulator	Klasa przepływu	Aksesoria	Wykończenie	Cena (PLN/szt.)
2453020	Ø40	B	---	Chrom	275,00

## 42. ANGELO

Bateria wannowo-natryskowa podtynkowa

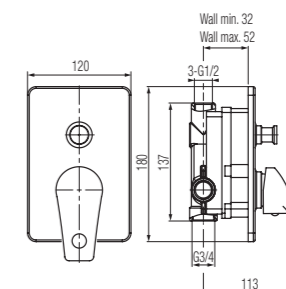

Kod	Regulator	Klasa przepływu	Aksesoria	Wykończenie	Cena (PLN/szt.)
2453280	Ø35	B/B	---	Chrom	426,00

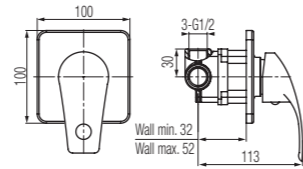
**43. ANGELO**Bateria natryskowa  
podtynkowa

Kod	Regulator	Klasa przepływu	Akcesoria	Wykończenie	Cena (PLN/szt.)
2453270	Ø35	B	---	Chrom	285,00

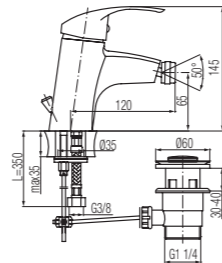
**44. ANGELO**Bateria bidetowa  
stojąca z korkiem spustowym

Kod	Regulator	Klasa przepływu	Akcesoria	Wykończenie	Cena (PLN/szt.)
2453050	Ø40	S	korek spustowy metalowy	Chrom	311,00

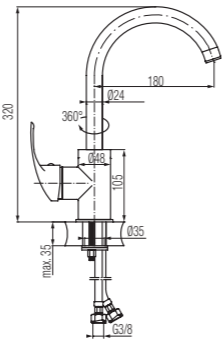
**45. ANGELO**Bateria kuchenna  
stojąca z dźwignią z boku,  
z obrotową wylewką

Kod	Regulator	Klasa przepływu	Akcesoria	Wykończenie	Cena (PLN/szt.)
2453030	Ø40	A	---	Chrom	417,00

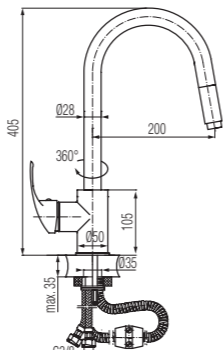
**46. ANGELO**Bateria kuchenna  
stojąca z wyciąganym natryskiem,  
z obrotową wylewką

Kod	Regulator	Klasa przepływu	Akcesoria	Wykończenie	Cena (PLN/szt.)
2453040	Ø40	A	---	Chrom	478,00

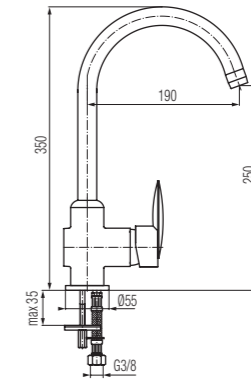
**47. DELTA**Bateria kuchenna  
stojąca z dźwignią z boku,  
z obrotową wylewką

Kod	Regulator	Klasa przepływu	Akcesoria	Wykończenie	Cena (PLN/szt.)
2450060	Ø40	A	---	Chrom	387,00

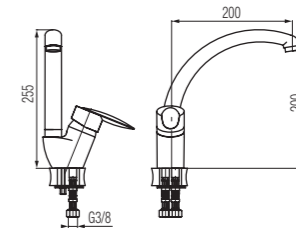
**48. DELTA**Bateria kuchenna  
stojąca z dźwignią z boku,  
z obrotową wylewką

Kod	Regulator	Klasa przepływu	Akcesoria	Wykończenie	Cena (PLN/szt.)
2450070	Ø40	A	---	Chrom	276,00

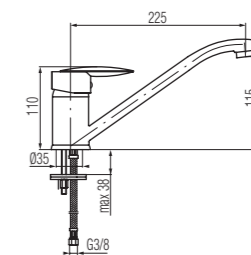
**49. DELTA**Bateria kuchenna  
stojąca z obrotową wylewką

Kod	Regulator	Klasa przepływu	Akcesoria	Wykończenie	Cena (PLN/szt.)
2450080	Ø40	Z	---	Chrom	232,00

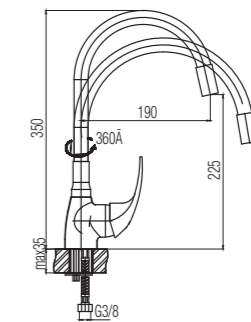
**50. FLEXI**Bateria kuchenna  
stojąca z obrotową wylewką

Kod	Regulator	Klasa przepływu	Akcesoria	Wykończenie	Cena (PLN/szt.)
2444100	Ø40	A	---	Chrom	178,00





LINEA

**1. ECO**

Bateria umywalkowa stojąca

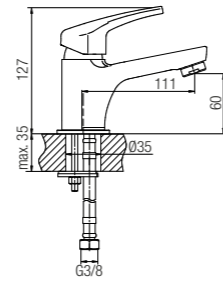

NEW!



Kod	Regulator	Klasa przepływu	Aksesoria	Wykończenie	Cena (PLN/szt.)
2406900	Ø40	A	---	Chrom	103,00

**2. ECO**

Bateria umywalkowa stojąca z korkiem spustowym

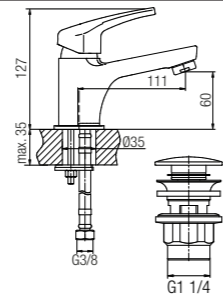

NEW!



Kod	Regulator	Klasa przepływu	Aksesoria	Wykończenie	Cena (PLN/szt.)
2406910	Ø40	A	korek spustowy	Chrom	124,00

**3. ECO**

Bateria wannowa ścienna

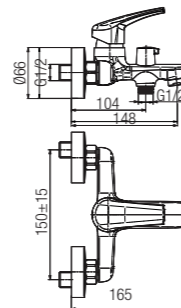

NEW!



Kod	Regulator	Klasa przepływu	Aksesoria	Wykończenie	Cena (PLN/szt.)
2406920	Ø40	B/B	---	Chrom	177,00

**4. ECO**

Bateria natryskowa ścienna

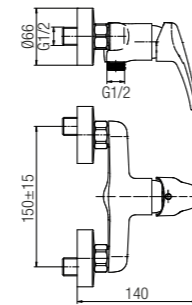

NEW!



Kod	Regulator	Klasa przepływu	Aksesoria	Wykończenie	Cena (PLN/szt.)
2406930	Ø40	B	---	Chrom	114,00

**5. LOGIC ECO**

Bateria umywalkowa stojąca z korkiem spustowym

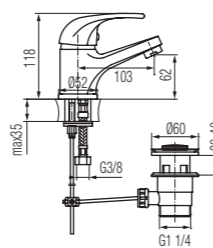

SAVE MONEY



Kod	Regulator	Klasa przepływu	Aksesoria	Wykończenie	Cena (PLN/szt.)
2450880	Ø40	Z	korek spustowy	Chrom	192,00

**6. LOGIC**

Bateria umywalkowa stojąca z korkiem spustowym

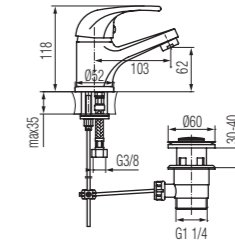

Kod	Regulator	Klasa przepływu	Aksesoria	Wykończenie	Cena (PLN/szt.)
2450900	Ø40	A	korek spustowy	Chrom	166,00

**7. LOGIC**

Bateria umywalkowa ścienna z obrotową wylewką

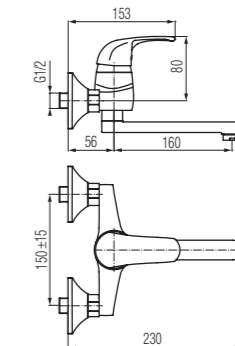

Kod	Regulator	Klasa przepływu	Aksesoria	Wykończenie	Cena (PLN/szt.)
2450920	Ø40	A	---	Chrom	201,00

**8. LOGIC**

Bateria wannowa ścienna z akcesoriami

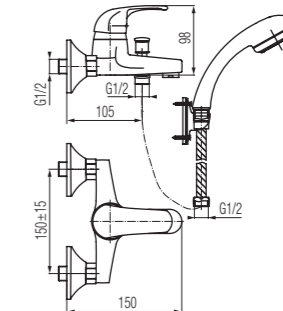

Kod	Regulator	Klasa przepływu	Aksesoria	Wykończenie	Cena (PLN/szt.)
2450910	Ø40	A/A	sluchawka, uchwyty punktowy, wąż natryskowy 1500 mm	Chrom	251,00

**9. LOGIC**

Bateria wannowa / umywalkowa z obrotową wylewką, ścienna z akcesoriami

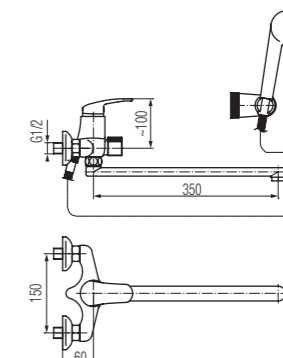

Kod	Regulator	Klasa przepływu	Aksesoria	Wykończenie	Cena (PLN/szt.)
2450750	Ø40	S/Z	sluchawka, uchwyty punktowy, wąż natryskowy 1500 mm	Chrom	indywidualne ustalenia

## 10. LOGIC

Bateria natryskowa  
ścienna z akcesoriami

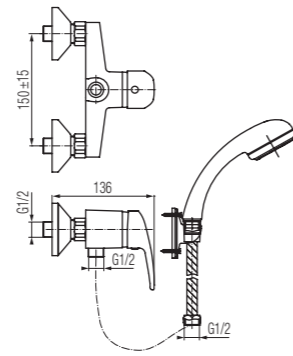

Kod	Regulator	Klasa przepływu	Akcesoria	Wykończenie	Cena (PLN/szt.)
2450950	Ø40	A	słuchawka, uchwyt punktowy, wąż natryskowy 1500 mm	Chrom	208,00

## 11. LOGIC

Bateria bidetowa  
stojąca z korkiem spustowym

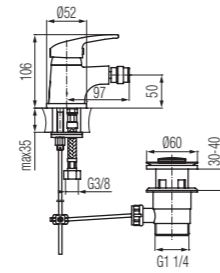

Kod	Regulator	Klasa przepływu	Akcesoria	Wykończenie	Cena (PLN/szt.)
2450990	Ø40	A	korek spustowy	Chrom	179,00

## 12. LOGIC

Bateria kuchenna  
stojąca z wyciąganym natryskiem,  
z obrotową wylewką

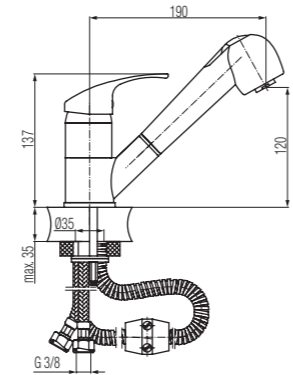

Kod	Regulator	Klasa przepływu	Akcesoria	Wykończenie	Cena (PLN/szt.)
2450960	Ø40	A	---	Chrom	329,00

## 13. LOGIC

Bateria kuchenna  
stojąca z obrotową wylewką

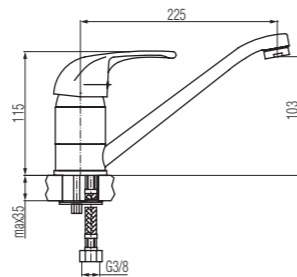

Kod	Regulator	Klasa przepływu	Akcesoria	Wykończenie	Cena (PLN/szt.)
2450930	Ø40	A	---	Chrom	153,00

## 14. LOGIC

Bateria kuchenna  
ścienna z obrotową wylewką

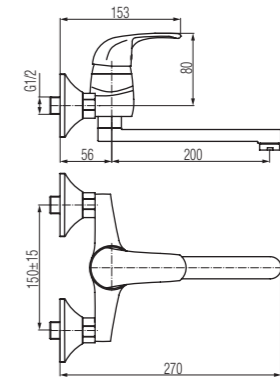

Kod	Regulator	Klasa przepływu	Akcesoria	Wykończenie	Cena (PLN/szt.)
2450940	Ø40	A	---	Chrom	206,00

## 15. GALEO

Bateria umywalkowa  
stojąca z korkiem spustowym

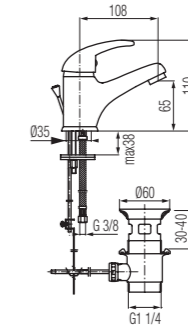

Kod	Regulator	Klasa przepływu	Akcesoria	Wykończenie	Cena (PLN/szt.)
2441000	Ø35	A	korek spustowy	Chrom	189,00

## 16. GALEO

Bateria umywalkowa  
stojąca z obrotową wylewką

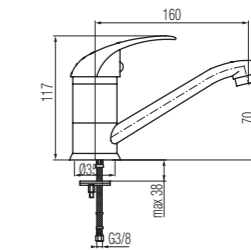

Kod	Regulator	Klasa przepływu	Akcesoria	Wykończenie	Cena (PLN/szt.)
2441420	Ø35	A	---	Chrom	189,00

## 17. GALEO

Bateria umywalkowa  
ścienna z obrotową wylewką

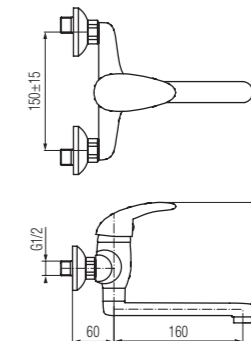

Kod	Regulator	Klasa przepływu	Akcesoria	Wykończenie	Cena (PLN/szt.)
2441020	Ø35	A	---	Chrom	229,00

## 18. GALEO

Bateria wannowa / umywalkowa ścienna z obrotową wylewką, z akcesoriami

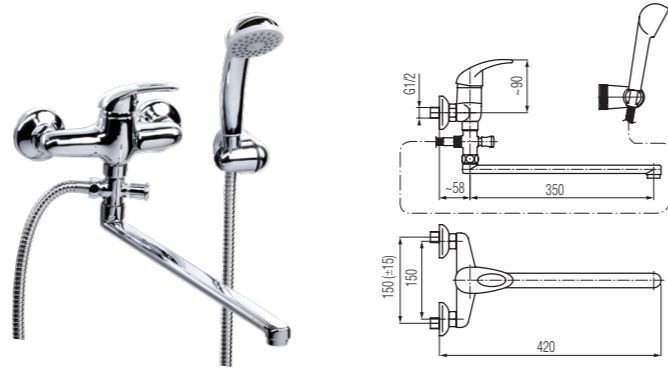

Kod	Regulator	Klasa przepływu	Akcesoria	Wykończenie	Cena (PLN/szt.)
2441070	Ø35	B	śluchawka, uchwyt punktowy, wąż natryskowy 1500 mm	Chrom	307,00

## 19. GALEO

Bateria wannowa ścienna z akcesoriami



Kod	Regulator	Klasa przepływu	Akcesoria	Wykończenie	Cena (PLN/szt.)
2441040	Ø35	B	śluchawka, uchwyt punktowy, wąż natryskowy 1500 mm	Chrom	293,00

## 21. GALEO

Bateria natryskowa ścienna z akcesoriami

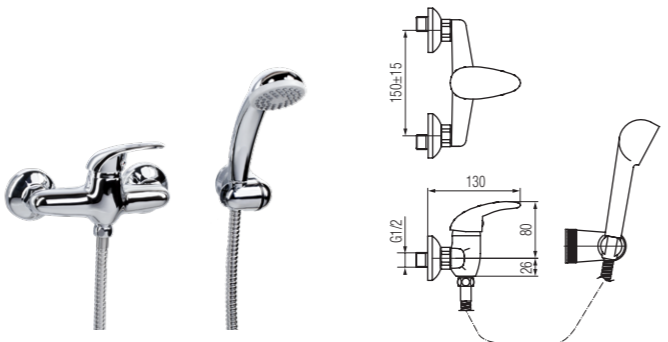

Kod	Regulator	Klasa przepływu	Akcesoria	Wykończenie	Cena (PLN/szt.)
2441050	Ø35	A	śluchawka, uchwyt punktowy, wąż natryskowy 1500 mm	Chrom	235,00

## 20. GALEO

Bateria bidetowa stojąca z korkiem spustowym

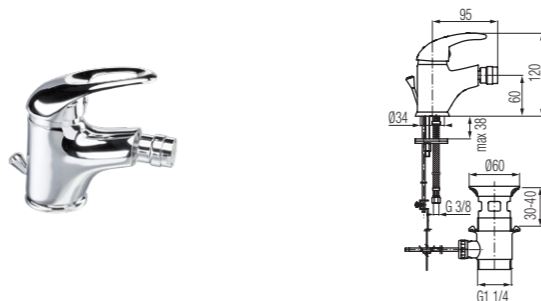

Kod	Regulator	Klasa przepływu	Akcesoria	Wykończenie	Cena (PLN/szt.)
2441060	Ø35	A	korek spustowy	Chrom	211,00

## 23. GALEO

Bateria kuchenna stojąca z obrotową wylewką

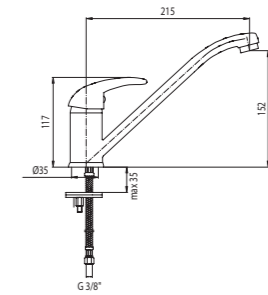

Kod	Regulator	Klasa przepływu	Akcesoria	Wykończenie	Cena (PLN/szt.)
2441010	Ø35	A	---	Chrom	190,00

## 24. GALEO

Bateria kuchenna ścienna z obrotową wylewką

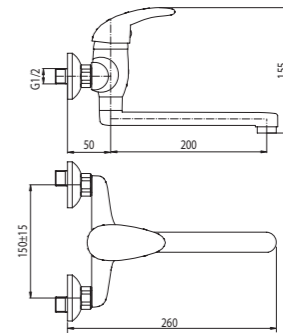

Kod	Regulator	Klasa przepływu	Akcesoria	Wykończenie	Cena (PLN/szt.)
2441030	Ø35	A	---	Chrom	227,00

## 25. CLASS

Bateria umywalkowa stojąca z obrotową wylewką

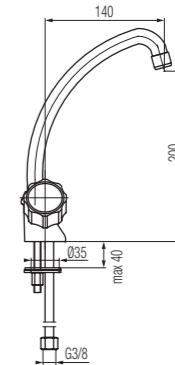

Kod	Regulator	Klasa przepływu	Akcesoria	Wykończenie	Cena (PLN/szt.)
2446000	głowica suwakowa	A	---	Chrom	165,00

## 22. CLASS

Bateria umywalkowa ścienna z obrotową wylewką

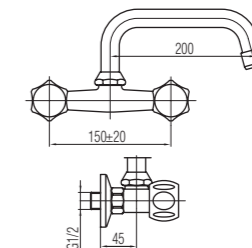

Kod	Regulator	Klasa przepływu	Akcesoria	Wykończenie	Cena (PLN/szt.)
2446010	głowica suwakowa	A	---	Chrom	202,00

**26. CLASS**

Bateria wannowa / umywalkowa  
ścienna z obrotową wylewką, z akcesoriami

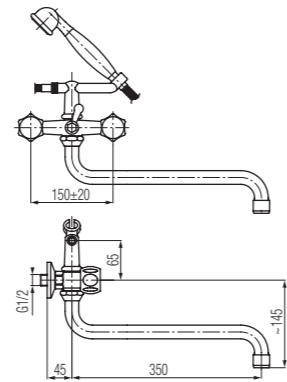

Kod	Regulator	Klasa przepływu	Akcesoria	Wykończenie	Cena (PLN/szt.)
<b>2446050</b>	głowica suwakowa	B	słuchawka, wąż natryskowy 1500 mm	Chrom	<b>439,00</b>

**30. CLASS**

Bateria kuchenna  
ścienna z obrotową wylewką

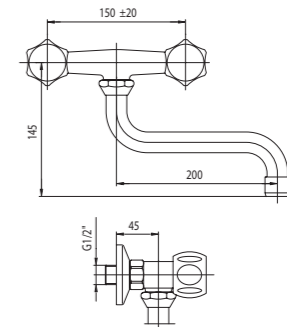

Kod	Regulator	Klasa przepływu	Akcesoria	Wykończenie	Cena (PLN/szt.)
<b>2446020</b>	głowica suwakowa	A	---	Chrom	<b>202,00</b>

**27. CLASS**

Bateria wannowa  
ścienna z akcesoriami

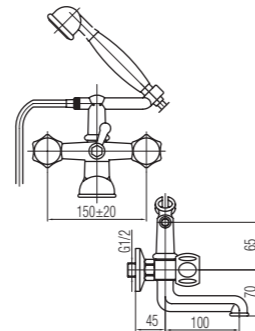

Kod	Regulator	Klasa przepływu	Akcesoria	Wykończenie	Cena (PLN/szt.)
<b>2446030</b>	głowica suwakowa	B/B	słuchawka, wąż natryskowy 1500 mm	Chrom	<b>334,00</b>

**28. CLASS**

Bateria natryskowa  
ścienna z akcesoriami

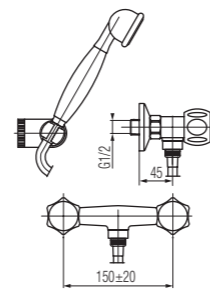

Kod	Regulator	Klasa przepływu	Akcesoria	Wykończenie	Cena (PLN/szt.)
<b>2446040</b>	głowica suwakowa	A	słuchawka, uchwyt punktowy, wąż natryskowy 1500 mm	Chrom	<b>214,00</b>

**29. CLASS**

Bateria kuchenna  
stojąca z obrotową wylewką

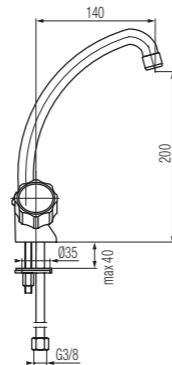

Kod	Regulator	Klasa przepływu	Akcesoria	Wykończenie	Cena (PLN/szt.)
<b>2446060</b>	głowica suwakowa	A	---	Chrom	<b>165,00</b>



ESTILL

### 1. ESTILL ROUND

Bateria termostaticzna wannowa

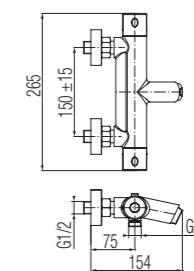

Kod	Regulator	Klasa przepływu	Akcesoria	Wykończenie	Cena (PLN/szt.)
2447160	głowica termostaticzna	B/C	---	● Chrom	562,00

### 2. ESTILL SQUARE PLUS

Bateria termostaticzna natryskowa

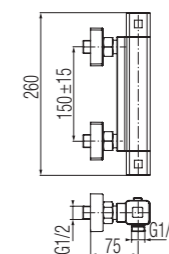

Kod	Regulator	Klasa przepływu	Akcesoria	Wykończenie	Cena (PLN/szt.)
2447170	głowica termostaticzna	B	---	● Chrom	562,00



### 3. ESTILL ROUND PLUS

Bateria termostaticzna natryskowa

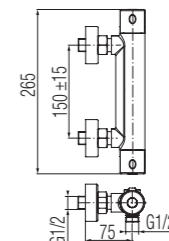

Kod	Regulator	Klasa przepływu	Akcesoria	Wykończenie	Cena (PLN/szt.)
2447150	głowica termostaticzna	B	---	● Chrom	489,00



25 YEARS LIMITED WARRANTY

48h SERVICE

BATERIE TERMOSTATYCZNE



BATERIE SPECIJALNE

**1. MEDICA**

Bateria umywalkowa stojąca z korkiem spustowym

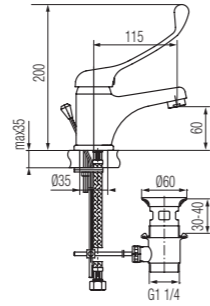

Kod	Regulator	Klasa przepływu	Aksesoria	Wykończenie	Cena (PLN/szt.)
<b>2401760</b>	Ø40	A	---	● Chrom	<b>358,00</b>

**2. MEDICA**

Bateria umywalkowa stojąca z obrotową wylewką

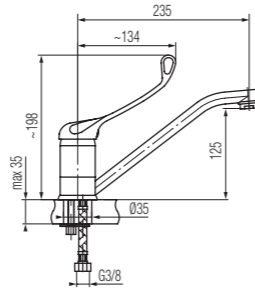

Kod	Regulator	Klasa przepływu	Aksesoria	Wykończenie	Cena (PLN/szt.)
<b>2401770</b>	Ø40	A	---	● Chrom	<b>334,00</b>

**3. MEDICA**

Bateria umywalkowa ścienna z obrotową wylewką

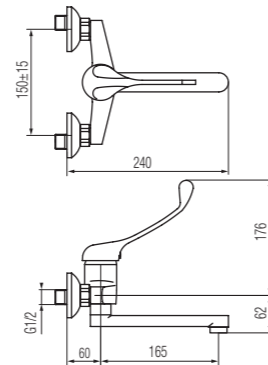

Kod	Regulator	Klasa przepływu	Aksesoria	Wykończenie	Cena (PLN/szt.)
<b>2400760</b>	Ø40	A	---	● Chrom	<b>413,00</b>

**4. MEDICA**

Bateria umywalkowa ścienna z długą, obrotową wylewką

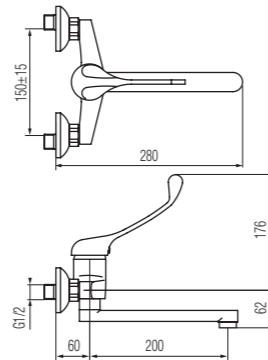

Kod	Regulator	Klasa przepływu	Aksesoria	Wykończenie	Cena (PLN/szt.)
<b>2400940</b>	Ø40	A	---	● Chrom	<b>397,00</b>

**5. SOLO**

Zawór stojący umywalkowy do wody zimnej lub gorącej

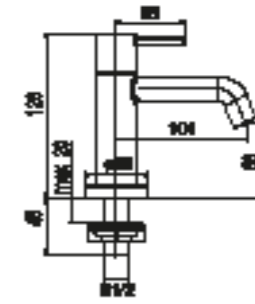

Kod	Regulator	Klasa przepływu	Aksesoria	Wykończenie	Cena (PLN/szt.)
<b>2452880</b>	zawór umywalkowy	A	---	● Chrom	<b>115,00</b>

**6. TIMEPRESS**

Zawór czasowy umywalkowy

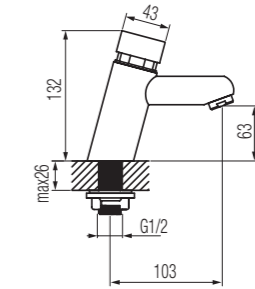

Kod	Regulator	Klasa przepływu	Aksesoria	Wykończenie	Cena (PLN/szt.)
<b>2452900</b>	zawór czasowy	A	---	● Chrom	<b>260,00</b>

**7. URIVEX**

Zawór sputkujący pisuarowy

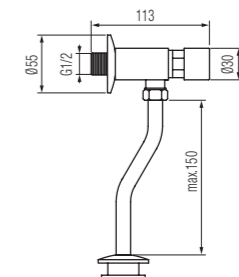

Kod	Regulator	Klasa przepływu	Aksesoria	Wykończenie	Cena (PLN/szt.)
<b>2452950</b>	zawór czasowy	S	---	● Chrom	<b>160,00</b>





### 1. ROSE

Zestaw natryskowy podtynkowy



**W skład zestawu wchodzi:**

- poz. 4 2445430
- poz. 13 2445420
- poz. 15 2445410

**NATRYSKI**

- poz. 7 2445350

**GLAMOUR LINE**

- poz. 5 2445270

Regulator	Klasa przepływu	Akcesoria	Wykończenie
Ø35	C/Z	sluchawka, ramię natrysku, głowica prysznicowa, przyłącze kątowe, wąż natryskowy 1500 mm	Rose Gold



### 2. DIONE

Zestaw natryskowy podtynkowy

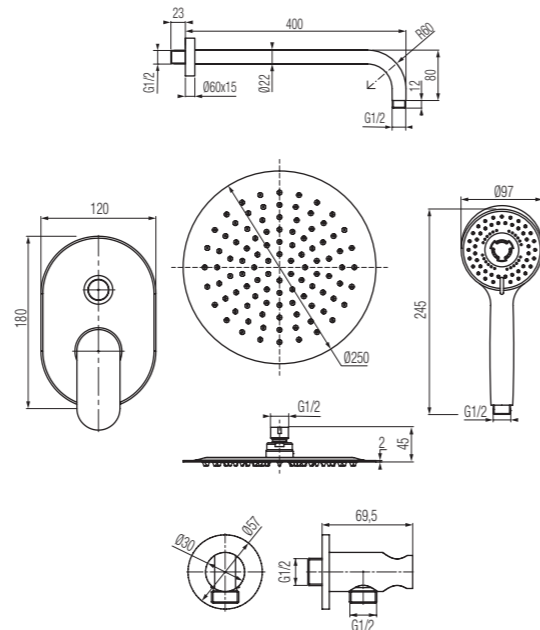

Kod	Regulator	Klasa przepływu	Akcesoria	Wykończenie	Cena (PLN/szt.)
2449990	Ø35	C/Z	sluchawka, ramię natrysku, głowica prysznicowa, przyłącze kątowe, wąż natryskowy 1500 mm	Chrom	1 102,00



### 3. CARRÉ

Zestaw natryskowy podtynkowy

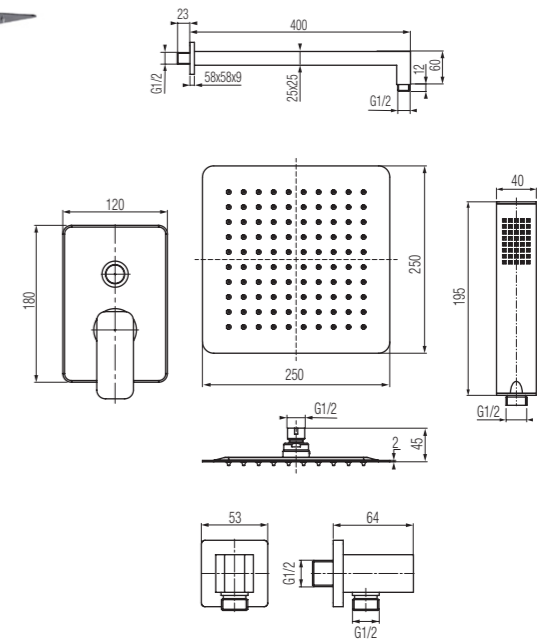

**DESIGN DLA KONESERA**  
PIĘKNO INNOWACJA PRESTIŻ  
2016

Kod	Regulator	Klasa przepływu	Akcesoria	Wykończenie	Cena (PLN/szt.)
2449980	Ø35	C/A	sluchawka, ramię natrysku, głowica prysznicowa, przyłącze kątowe, wąż natryskowy 1500 mm	Chrom	1 366,00



### 4. DIONE

Głowica prysznicowa

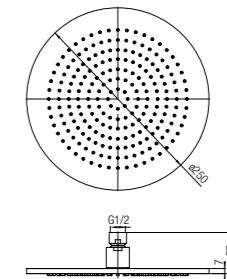

Kod	Wymiary	Akcesoria	Wykończenie	Cena (PLN/szt.)
2445430	Ø 250 mm	---	Rose Gold	563,00



### 5. DIONE BLACK

Głowica prysznicowa

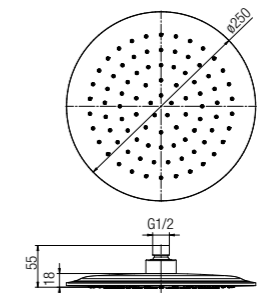

Kod	Wymiary	Akcesoria	Wykończenie	Cena (PLN/szt.)
2445960	Ø 250 mm	---	Black	359,00



**6. DIONE**

Głowica prysznicowa

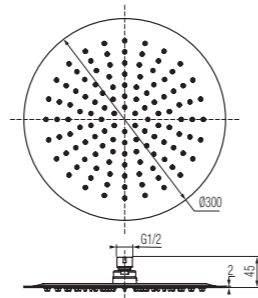

Kod	Wymiary	Akcesoria	Wykończenie	Cena (PLN/szt.)
<b>2448420</b>	ø 300 mm	---	Chrom	<b>491,00</b>

**7. DIONE**

Głowica prysznicowa

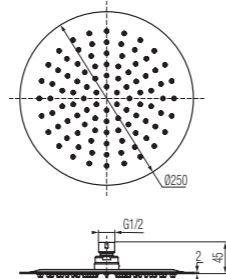

Kod	Wymiary	Akcesoria	Wykończenie	Cena (PLN/szt.)
<b>2448410</b>	ø 250 mm	---	Chrom	<b>369,00</b>

**8. DIONE**

Głowica prysznicowa

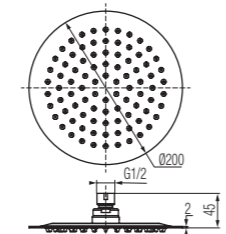

Kod	Wymiary	Akcesoria	Wykończenie	Cena (PLN/szt.)
<b>2448400</b>	ø 200 mm	---	Chrom	<b>298,00</b>

**9. CARRÉ BLACK**

Głowica prysznicowa

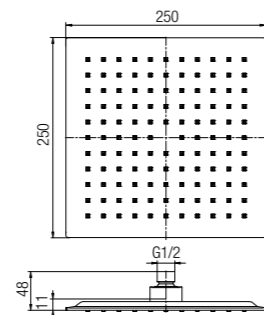

Kod	Wymiary	Akcesoria	Wykończenie	Cena (PLN/szt.)
<b>2445980</b>	ø 250 mm	---	Black	<b>389,00</b>

**10. CARRÉ**

Głowica prysznicowa

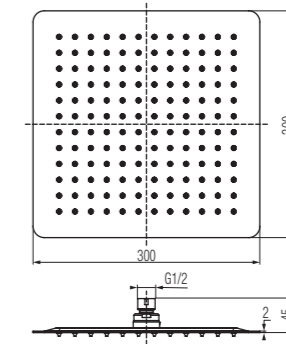

Kod	Wymiary	Akcesoria	Wykończenie	Cena (PLN/szt.)
<b>2448450</b>	300 x 300 mm	---	Chrom	<b>537,00</b>

**11. CARRÉ**

Głowica prysznicowa

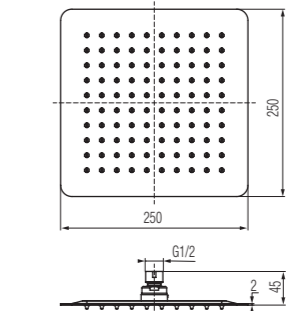

Kod	Wymiary	Akcesoria	Wykończenie	Cena (PLN/szt.)
<b>2448440</b>	250 x 250 mm	---	Chrom	<b>405,00</b>

**12. CARRÉ**

Głowica prysznicowa

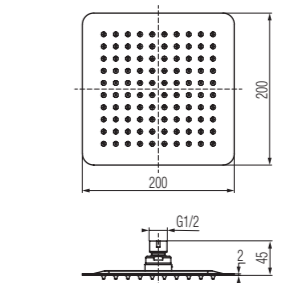

Kod	Wymiary	Akcesoria	Wykończenie	Cena (PLN/szt.)
<b>2448430</b>	200 x 200 mm	---	Chrom	<b>311,00</b>

**13. ROUND**

Ramię natrysku ścienne

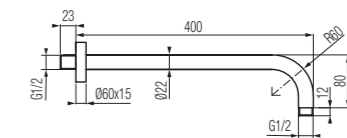

Kod	Wymiary	Akcesoria	Wykończenie	Cena (PLN/szt.)
<b>2448460</b>	400 mm	---	Chrom	<b>146,00</b>
<b>2445420</b>	400 mm	---	Rose Gold	<b>217,00</b>
<b>2444660</b>	400 mm	---	Black	<b>149,00</b>

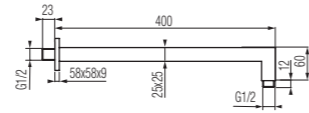
**14. KVADRO**Ramię natrysku  
ścienne

NEW!

Kod	Wymiary	Aksesoria	Wykończenie	Cena (PLN/szt.)
2448470	400 mm	---	● Chrom	220,00
2444610	400 mm	---	● Black	219,00

**15. ROUND PLUS**

Przyłącze kątowe

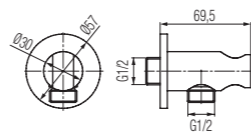

NEW!

Kod	Wymiary	Aksesoria	Wykończenie	Cena (PLN/szt.)
2448310	G 1/2	---	● Chrom	161,00
2445410	G 1/2	---	● Rose Gold	241,00
2444670	G 1/2	---	● Black	159,00

**16. ROUND**

Przyłącze kątowe

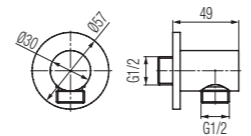

NEW!

Kod	Wymiary	Aksesoria	Wykończenie	Cena (PLN/szt.)
2448300	G 1/2	---	● Chrom	133,00
2445400	G 1/2	---	● Rose Gold	206,00
2444680	G 1/2	---	● Black	139,00

**17. KVADRO PLUS**

Przyłącze kątowe

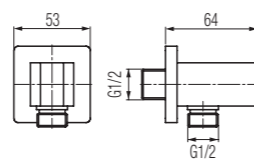

NEW!

Kod	Wymiary	Aksesoria	Wykończenie	Cena (PLN/szt.)
2448330	G 1/2	---	● Chrom	176,00
2444620	G 1/2	---	● Black	179,00

**18. KVADRO**

Przyłącze kątowe

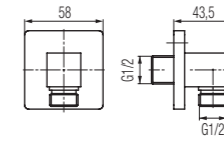

NEW!

Kod	Wymiary	Aksesoria	Wykończenie	Cena (PLN/szt.)
2448320	G 1/2	---	● Chrom	146,00
2444630	G 1/2	---	● Black	139,00

**19. ROUND**

Wylewka wannowa podtynkowa

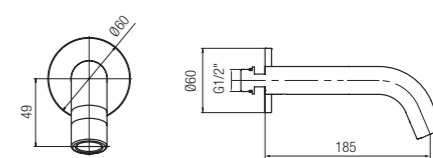

Kod	Wymiary	Aksesoria	Wykończenie	Cena (PLN/szt.)
2455520	G 1/2	---	● Chrom	172,10

**20. KVADRO**

Wylewka wannowa podtynkowa

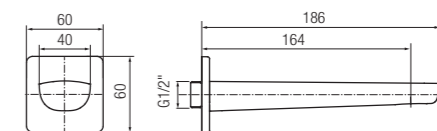

Kod	Wymiary	Aksesoria	Wykończenie	Cena (PLN/szt.)
2455500	G 1/2	---	● Chrom	196,40



ZESTAWY NATRYSKOWE

## 1. CUBUS

Zestaw natryskowy z baterią termostaticzną

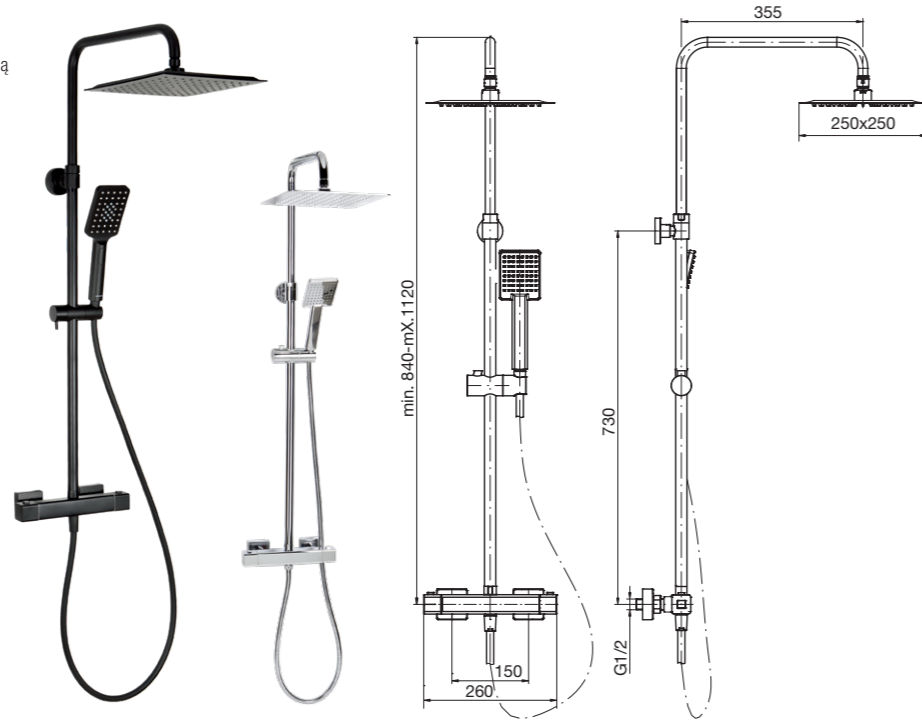

Kod	Regulator	Klasa przepływu	Aksesoria	Wykończenie	Cena (PLN/szt.)
2447140	---	B/A	słuchawka, głowica prysznicowa, uchwyt punktowy, wąż natryskowy 1500 mm	Chrom	1 069,00
2447130	---	B/A	słuchawka, głowica prysznicowa, uchwyt punktowy, wąż natryskowy 1500 mm	Black	1 088,00



## 2. DIYA

Zestaw natryskowy z baterią termostaticzną

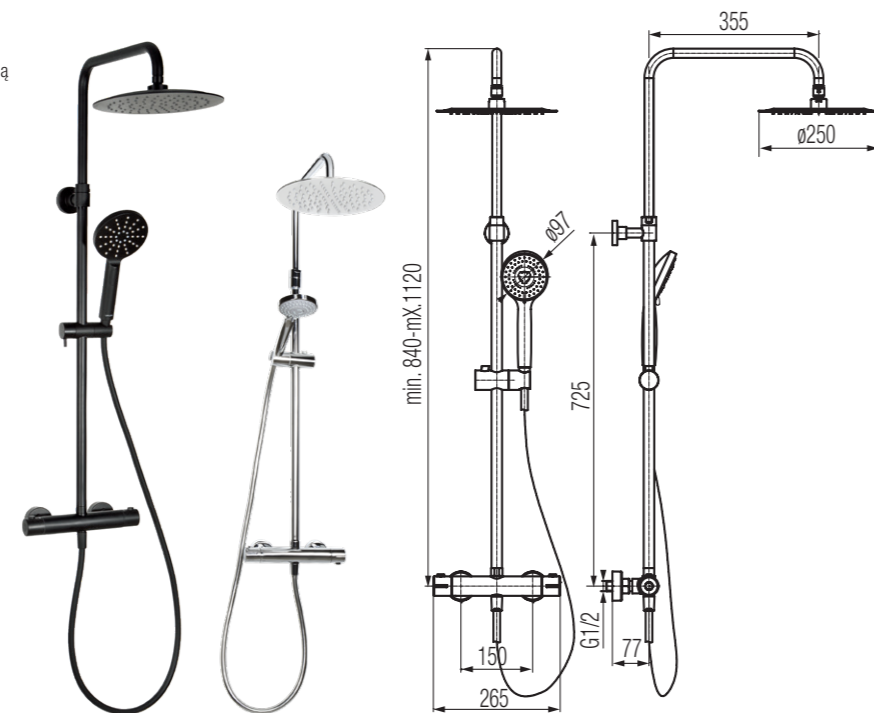

Kod	Regulator	Klasa przepływu	Aksesoria	Wykończenie	Cena (PLN/szt.)
2447190	---	B/A	słuchawka, głowica prysznicowa, uchwyt punktowy, wąż natryskowy 1500 mm	Chrom	1 189,00
2447120	---	B/A	słuchawka, głowica prysznicowa, uchwyt punktowy, wąż natryskowy 1500 mm	Black	1 205,00



## 3. LOFT

Zestaw natryskowy

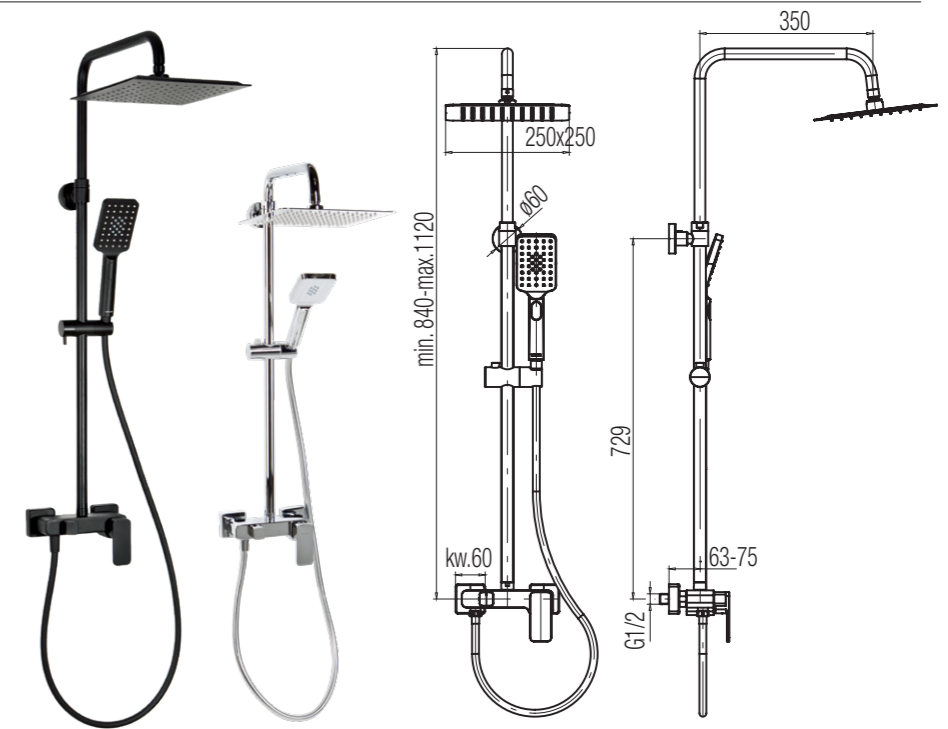

Kod	Regulator	Klasa przepływu	Aksesoria	Wykończenie	Cena (PLN/szt.)
2455740	---	B/A	słuchawka, głowica prysznicowa, uchwyt punktowy, wąż natryskowy 1500 mm	Chrom	867,00
2455750	---	B/A	słuchawka, głowica prysznicowa, uchwyt punktowy, wąż natryskowy 1500 mm	Black	940,00



## 4. TUBE

Zestaw natryskowy

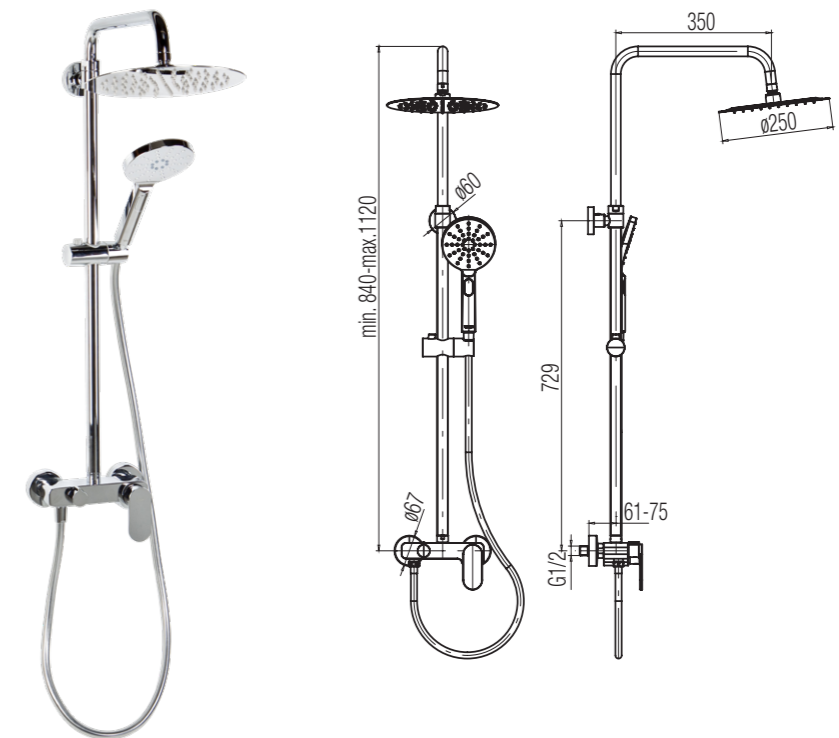

Kod	Regulator	Klasa przepływu	Aksesoria	Wykończenie	Cena (PLN/szt.)
2455700	---	B/A	słuchawka, głowica prysznicowa, uchwyt punktowy, wąż natryskowy 1500 mm	Chrom	867,00



**6. FARO**

Natrysk przesuwny  
5-funkcyjny z mydelniczką

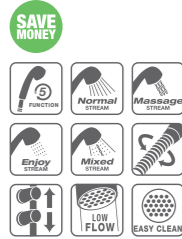
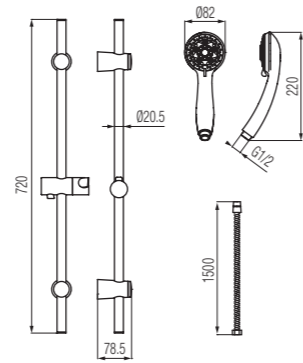

Kod	Regulator	Klasa przepływu	Akcesoria	Wykończenie	Cena (PLN/szt.)
2449960	---	Z	słuchawka, uchwyt punktowy, wąż natryskowy 1500 mm	Chrom	200,00

**5. COOL**

Natrysk przesuwny  
3-funkcyjny z mydelniczką

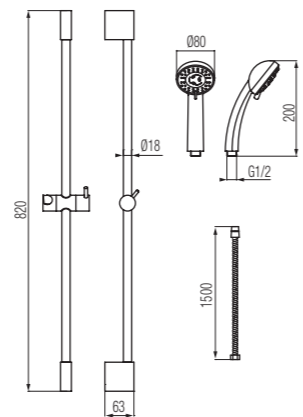

Kod	Regulator	Klasa przepływu	Akcesoria	Wykończenie	Cena (PLN/szt.)
2449940	---	Z	słuchawka, uchwyt punktowy, wąż natryskowy 1500 mm	Chrom	197,50

**7. ROSE**

Zestaw natryskowy  
punktowy 1-funkcyjny

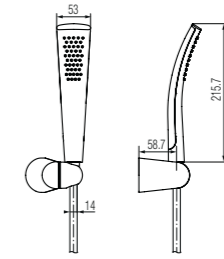

Kod	Regulator	Klasa przepływu	Akcesoria	Wykończenie	Cena (PLN/szt.)
2445350	---	Z	---	Rose Gold	153,40

**8. LOFT GOLD**

Zestaw natryskowy  
punktowy 3-funkcyjny

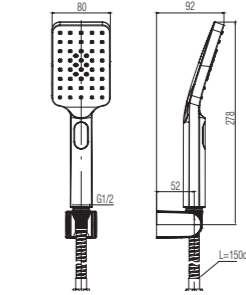

Kod	Regulator	Klasa przepływu	Akcesoria	Wykończenie	Cena (PLN/szt.)
2455850	---	S/Z	---	Gold	228,40

**9. WET**

Zestaw natryskowy  
punktowy 5-funkcyjny

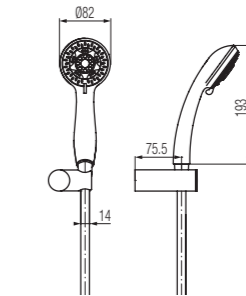

Kod	Regulator	Klasa przepływu	Akcesoria	Wykończenie	Cena (PLN/szt.)
2449560	---	Z	---	Chrom	120,20

**10. VERA**

Zestaw natryskowy  
punktowy 3-funkcyjny

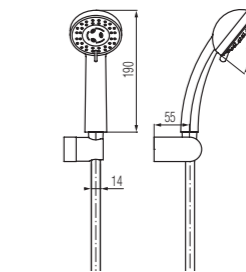

Kod	Regulator	Klasa przepływu	Akcesoria	Wykończenie	Cena (PLN/szt.)
2449550	---	Z	---	Chrom	104,30

**11. FRESCO**

Zestaw bidetowy

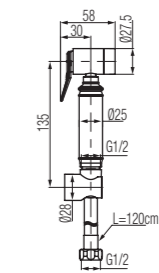

Kod	Wykończenie	Cena (PLN/szt.)
2449490	Chrom	108,40



# AKCESORIA



**1. DALI BLACK**

Sluchawka

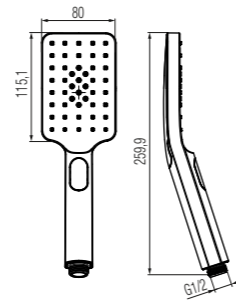

Kod	Wykończenie	Cena (PLN/szt.)
2445720	Black	79,80

**2. DALI WHITE**

Sluchawka

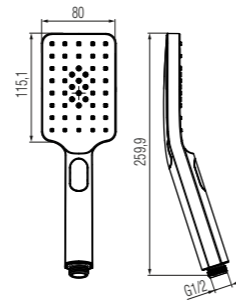

Kod	Wykończenie	Cena (PLN/szt.)
2445710	White	79,80

**3. DALI**

Sluchawka

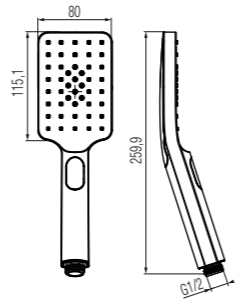

Kod	Wykończenie	Cena (PLN/szt.)
2445700	Chrom	75,20

**4. ROUND BLACK**

Sluchawka

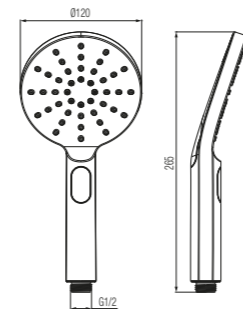

Kod	Wykończenie	Cena (PLN/szt.)
2445770	Black	83,30

**5. ROUND WHITE**

Sluchawka

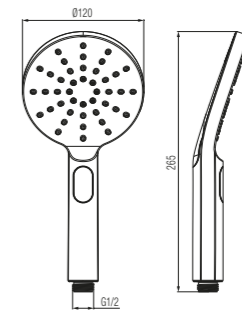

Kod	Wykończenie	Cena (PLN/szt.)
2445760	White	83,30

**6. ROUND**

Sluchawka

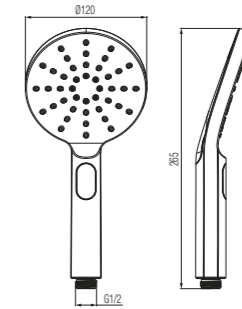

Kod	Wykończenie	Cena (PLN/szt.)
2445750	Chrom	78,50

**7. COZY**

Sluchawka 5-funkcyjna

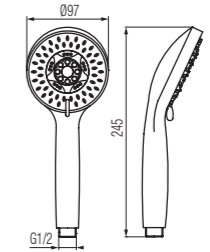

Kod	Wykończenie	Cena (PLN/szt.)
2449460	Chrom	56,60

**8. WET**

Sluchawka 5-funkcyjna

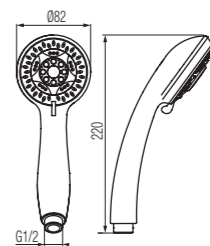

Kod	Wykończenie	Cena (PLN/szt.)
2449450	Chrom	45,00

**9. VERA**Słuchawka  
3-funkcyjna

SAVE MONEY

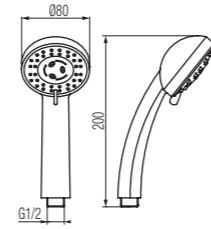

Kod	Wykończenie	Cena (PLN/szt.)
2449430	Chrom	44,50

**10. EASY**Słuchawka  
3-funkcyjna

SAVE MONEY

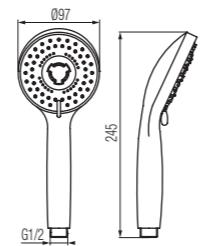

Kod	Wykończenie	Cena (PLN/szt.)
2449440	Chrom	56,60

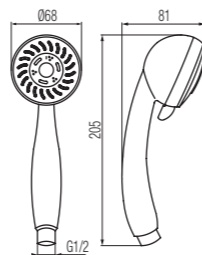
**11. TOSCA**Słuchawka  
3-funkcyjna

Kod	Wykończenie	Cena (PLN/szt.)
2449230	Chrom	37,70

**12. SOUL**

Słuchawka



SAVE MONEY

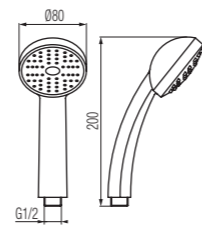

Kod	Wykończenie	Cena (PLN/szt.)
2449420	Chrom	37,60

**13. CARRÉ**

Słuchawka

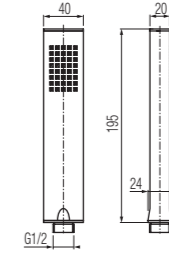

Kod	Wykończenie	Cena (PLN/szt.)
2328280	Chrom	124,40

**14. ORTA**

Słuchawka

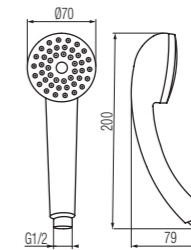

Kod	Wykończenie	Cena (PLN/szt.)
2449410	Chrom	24,00

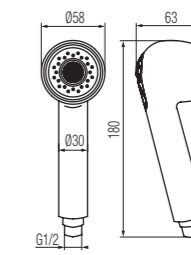
**15. UMBRA**Słuchawka 2-funkcyjna  
do baterii z wyciąganą wylewką

Kod	Wykończenie	Cena (PLN/szt.)
2449310	Chrom	41,70

**16. SIMPLE**

Słuchawka 1-funkcyjna

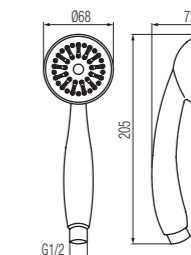

Kod	Wykończenie	Cena (PLN/szt.)
2449360	Chrom	25,00

**17. BLACK**

Wąż natryskowy PCV

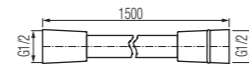

Kod	Wymiary	Wykończenie	Cena (PLN/szt.)
<b>2445730</b>	1500 mm	● Black	<b>59,40</b>

**18. CARRÉ**

Wąż natryskowy PCV

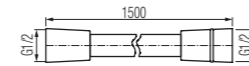

Kod	Wymiary	Cena (PLN/szt.)
<b>2500070</b>	1500 mm	<b>115,50</b>

**19. SILVER**

Wąż natryskowy

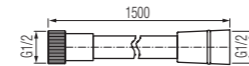

Kod	Wymiary	Cena (PLN/szt.)
<b>2501400</b>	1500 mm	<b>60,80</b>

**20. TIPO**

Wąż natryskowy 1/2" w oplocie plastikowym

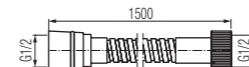

Kod	Wymiary	Cena (PLN/szt.)
<b>2500370</b>	1500 mm	<b>49,90</b>

**21. ACERO**

Wąż natryskowy w oplocie ze stali nierdzewnej



Kod	Wymiary	Cena (PLN/szt.)
<b>2449850</b>	1200 mm	<b>31,60</b>
<b>2449860</b>	1500 mm	<b>36,60</b>
<b>2449870</b>	1750 mm	<b>41,70</b>
<b>2449880</b>	2000 mm	<b>42,50</b>

**22. PROTECT**

Wąż elastyczny w oplocie ze stali nierdzewnej

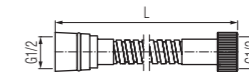

Kod	Wymiary	Cena (PLN/szt.)
<b>2449890</b>	1200-1650 mm	<b>38,40</b>
<b>2449900</b>	1500-2000 mm	<b>43,20</b>
<b>2449910</b>	1750-2150 mm	<b>48,30</b>

**23. UMBRA**

Wąż do baterii z wyciąganą wylewką

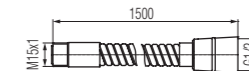

Kod	Wymiary	Cena (PLN/szt.)
<b>2402790</b>	1500 mm	<b>84,30</b>

**24. COMODO**

Drażek prysznicowy

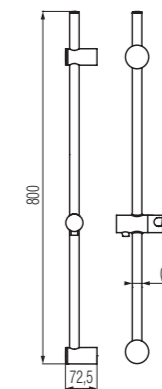

Kod	Wykończenie	Cena (PLN/szt.)
<b>2600750</b>	● Chrom	<b>82,20</b>

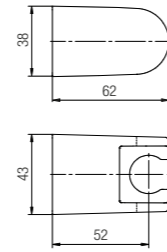
**25. BLACK**Uchwyt punktowy  
do słuchawki

NEW!

Kod	Wykończenie	Cena (PLN/szt.)
<b>2445600</b>	● Black Mat	<b>41,20</b>

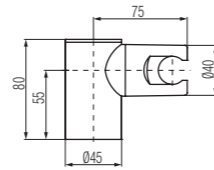
**26. WET**Uchwyt punktowy  
do słuchawki

Kod	Wykończenie	Cena (PLN/szt.)
<b>2449380</b>	● Chrom	<b>23,30</b>

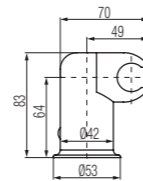
**27. STANDARD**Uchwyt punktowy  
do słuchawki

Kod	Wykończenie	Cena (PLN/szt.)
<b>2449400</b>	● Chrom	<b>35,60</b>

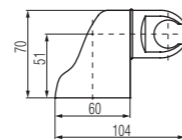
**28. SONATA**Uchwyt punktowy  
do słuchawki

Kod	Wykończenie	Cena (PLN/szt.)
<b>2404540</b>	● Chrom	<b>25,70</b>

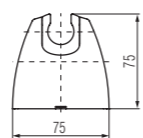
**29. PICO**Uchwyt punktowy  
do słuchawki

Kod	Wykończenie	Cena (PLN/szt.)
<b>2449390</b>	● Chrom	<b>33,40</b>

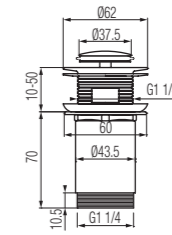
**30. STAR**Korek spustowy click-clack  
do umywalk z przelewem

Kod	Wykończenie	Ilość szt. w opak.	Cena (PLN/szt.)
<b>2452500</b>	Chrom	1/50	<b>93,50</b>
<b>2452510</b>	Rose Gold	1/50	<b>98,10</b>

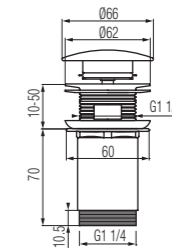
**31. VEGA**Korek spustowy click-clack  
do umywalk z przelewem

Kod	Ilość szt. w opak.	Cena (PLN/szt.)
<b>2452550</b>	1/50	<b>100,70</b>

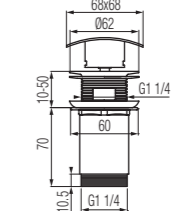
**32. SQUARE**Korek spustowy click-clack  
do umywalk z przelewem

Kod	Ilość szt. w opak.	Cena (PLN/szt.)
<b>2452600</b>	1/50	<b>111,40</b>

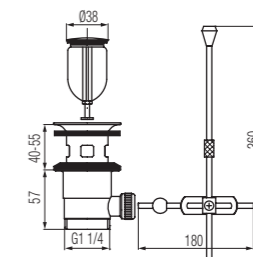
**33. EKO**Korek spustowy  
z tworzywa z ciągnem

Kod	Ilość szt. w opak.	Cena (PLN/szt.)
<b>2452650</b>	1/50	<b>16,20</b>

**34. CLASS U 200 mm**

Wylewka



Kod	Ilość szt. w opak.	Wykończenie	Cena (PLN/szt.)
2403030	1/15	Chrom	18,00

**35. CLASS S 200 mm**

Wylewka



Kod	Ilość szt. w opak.	Wykończenie	Cena (PLN/szt.)
2403040	1/10	Chrom	20,40

**36. CLASS S 250 mm**

Wylewka

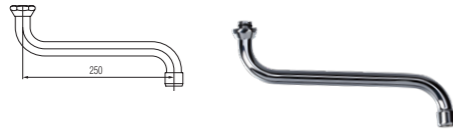

Kod	Ilość szt. w opak.	Wykończenie	Cena (PLN/szt.)
2403050	1/40	Chrom	17,20

**37. STANDARD 300 mm**

Wylewka



Kod	Ilość szt. w opak.	Wykończenie	Cena (PLN/szt.)
2403350	1/40	Chrom	60,80

**38. ATLANTA 200 mm**

Wylewka



Kod	Ilość szt. w opak.	Wykończenie	Cena (PLN/szt.)
2404850	1/8	Chrom	57,40

**39. STANDARD 160 mm**

Wylewka



Kod	Ilość szt. w opak.	Wykończenie	Cena (PLN/szt.)
2404860	1/18	Chrom	58,60

**40. STANDARD 200 mm**

Wylewka

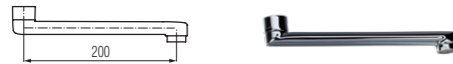

Kod	Ilość szt. w opak.	Wykończenie	Cena (PLN/szt.)
2404870	1/8	Chrom	63,90

**41. MEDICA**

Dźwignia



Kod	Ilość szt. w opak.	Wykończenie	Cena (PLN/szt.)
2400990	1/20	Chrom	47,10

**42. ECO PLUS**

Klucz do perlatora



Kod	Ilość szt. w opak.	Wykończenie	Cena (PLN/szt.)
2403530	1	---	6,55

**43. STANDARD**

Perlator



Kod	Ilość szt. w opak.	Wykończenie	Cena (PLN/szt.)
2402860	10/50	Chrom	14,90

**44. STANDARD**

Perlator



Kod	Ilość szt. w opak.	Wykończenie	Cena (PLN/szt.)
2402870	10/50	Chrom	17,20

**45. ECO**

Perlator



Kod	Ilość szt. w opak.	Wykończenie	Cena (PLN/szt.)
2403510	50/150	Chrom	20,50

**46. ECO PLUS**

Perlator



Kod	Ilość szt. w opak.	Wykończenie	Cena (PLN/szt.)
2403520	50/150	Plastik	27,40

**47. CLASS**

Głowica z pokrętkiem do baterii Class - lewe



Kod	Ilość szt. w opak.	Wykończenie	Cena (PLN/szt.)
2426130	1/27	Chrom	35,70

**48. CLASS**

Głowica z pokrętkiem do baterii Class - prawe



Kod	Ilość szt. w opak.	Wykończenie	Cena (PLN/szt.)
2426120	1/27	Chrom	35,70

**51. STANDARD**

Głowica suwakowa G 1/2



Kod	Ilość szt. w opak.	Wykończenie	Cena (PLN/szt.)
2402910	1/100	Mosiądz	14,20

**52. CLASS / KRYSZTAŁ**

Głowica suwakowa G 1/2 do baterii Class i Kryształ



Kod	Ilość szt. w opak.	Wykończenie	Cena (PLN/szt.)
2403440	1/100	Mosiądz	13,70

**49. STANDARD ø35**

Mieszacz baterii bez dystrybutora (niski)



Kod	Ilość szt. w opak.	Wykończenie	Cena (PLN/szt.)
2402740	1/30	---	60,80

**50. STANDARD ø40**

Mieszacz baterii bez dystrybutora (niski)



Kod	Ilość szt. w opak.	Wykończenie	Cena (PLN/szt.)
2402850	1/25	---	60,80

**53. KLIK ø35**Mieszacz  
z dystrybutorem niski

Kod	Ilość szt. w opak.	Wykończenie	Cena (PLN/szt.)
2440660	1/30	---	72,50

**54. KLIK ø35**Mieszacz  
z dystrybutorem wysoki

Kod	Ilość szt. w opak.	Wykończenie	Cena (PLN/szt.)
2440650	1/25	---	72,50

**56. STANDARD PLUS ø35**Mieszacz  
z dystrybutorem wysoki

Kod	Ilość szt. w opak.	Wykończenie	Cena (PLN/szt.)
2402750	1/25	---	60,80

**57. STANDARD PLUS ø40**Mieszacz  
z dystrybutorem wysoki

Kod	Ilość szt. w opak.	Wykończenie	Cena (PLN/szt.)
2402840	1/25	---	60,80

**58. STANDARD**Mieszacz do baterii z górnym  
uszczelnieniem, wysoki 35 mm

Kod	Ilość szt. w opak.	Wykończenie	Cena (PLN/szt.)
2440670	1/25	---	60,80

**59. STANDARD**Mieszacz do baterii z górnym  
uszczelnieniem, niski 35 mm

Kod	Ilość szt. w opak.	Wykończenie	Cena (PLN/szt.)
2440680	1/25	---	60,80

**63. GALA / GALEO**

Przełącznik natrysku



Kod	Ilość szt. w opak.	Wykończenie	Cena (PLN/szt.)
2441690	1/40	Chrom	26,20

**64. TUBE**

Przełącznik natrysku



Kod	Ilość szt. w opak.	Wykończenie	Cena (PLN/szt.)
2452470	1/40	Chrom	43,50

**55. LOFT**

Przełącznik natrysku



Kod	Ilość szt. w opak.	Wykończenie	Cena (PLN/szt.)
2452480	1/40	Chrom	43,50

**60. ANGELO**

Przełącznik natrysku



Kod	Ilość szt. w opak.	Wykończenie	Cena (PLN/szt.)
2452490	1/40	Chrom	43,50

**61. CLASS/CRYSTAL**

Przełącznik natrysku



Kod	Ilość szt. w opak.	Wykończenie	Cena (PLN/szt.)
2446110	1/20	Chrom	30,40

**62. V-BOX**

Przełącznik natrysku

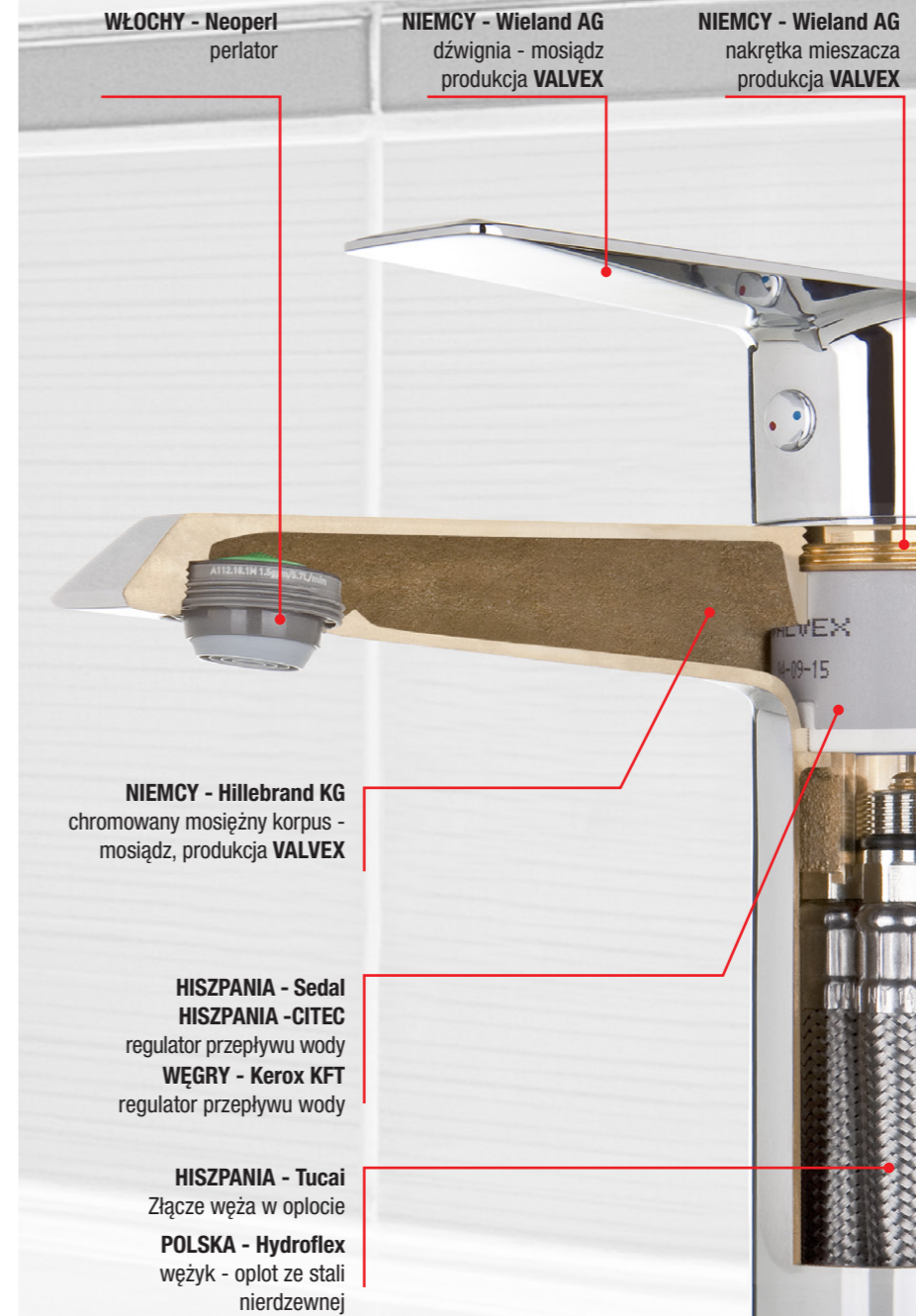

Kod	Ilość szt. w opak.	Wykończenie	Cena (PLN/szt.)
2454290	1/30	Chrom	77,40

**NASI DOSTAWCY MATERIAŁÓW I CZĘŚCI**



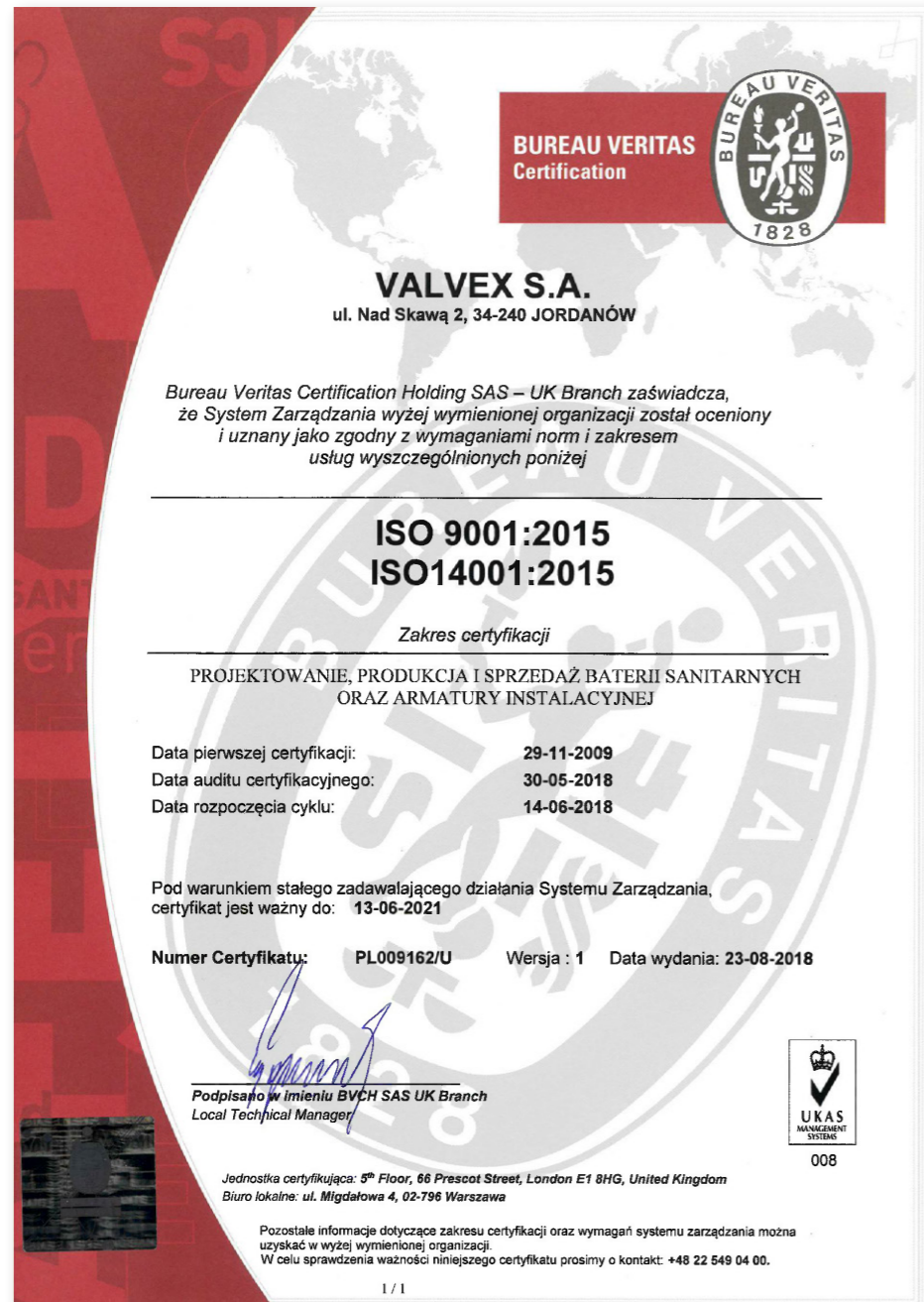

## OGÓLNE WARUNKI SPRZEDAŻY

Dostawy wyrobów firmy VALVEX odbywają się zgodnie z zasadami i warunkami umów handlowych zawartych z kontrahentami, ogólnymi warunkami sprzedaży zawartymi w niniejszym dokumencie oraz na podstawie cen katalogowych netto obowiązujących w dniu złożenia zamówienia.

Do cen zawartych w aktualnym cenniku VALVEX należy doliczyć VAT wg aktualnie obowiązującej stawki.

Modyfikacje zasad i warunków dostaw są obowiązujące tylko i wyłącznie, jeżeli zostały zaakceptowane przez VALVEX w formie pisemnej.

Zamówienia na wszystkie wyroby muszą być składane w formie pisemnej (dopuszczalne są również fax i e-mail). Wyroby z przeznaczeniem na ekspozycję należy zamawiać oddzielnie. Błędy zamówienia obciążają Zamawiającego.

Wszystkie wyroby VALVEX są zapakowane fabrycznie w sposób zapewniający bezpieczny transport przeznaczonymi do tego celu środkami transportu.

Odbiorca odbierający towar własnym transportem jest zobowiązany sprawdzić przy załadunku, czy dostawa jest zgodna z fakturą i dokumentem WZ, czy opakowania nie są uszkodzone oraz ma prawo sprawdzenia kompletności wyrobów w poszczególnych opakowaniach. Jeżeli Odbiorca nie zgłosi zastrzeżeń co do kompletności dostawy, stanu opakowań i sposobu załadunku przed opuszczeniem terenu VALVEX, dostawę, opakowania i załadunek uważa się za prawidłowe. W tym przypadku ryzyko uszkodzenia lub utraty towaru przechodzi na Kupującego.

Jeżeli dostawa odbywa się transportem VALVEX lub firmą spedycyjną (kurierską), Odbiorca zobowiązany jest zgłosić naruszenie lub uszkodzenie przesyłki (np: zerwanie folii zabezpieczającej, taśmy z logiem VALVEX lub taśmy OCHRONA) lub ewentualne zastrzeżenia do stanu opakowań dostarczonych wyrobów i zgodności dostawy z fakturą i dokumentem WZ, kierowcy przewoźnika, w formie pisemnej przy odbiorze towaru. Jeżeli nie wniesiono pisemnych zastrzeżeń, wyroby uważa się za dostarczone w nieuszkodzonych opakowaniach, zgodnie z fakturą i dokumentem WZ, a ryzyko uszkodzenia lub utraty towaru przechodzi z tą chwilą na Kupującego. Odbiorca zobowiązany jest do zapewnienia odpowiednich sił i środków gwarantujących sprawny rozładunek wyrobów dostarczonych transportem VALVEX.

VALVEX w żadnym przypadku nie ponosi odpowiedzialności za uszkodzenia i straty powstałe w wyniku nieodpowiedniego transportu przez Odbiorcę lub firmę przez niego wynajętą oraz wynikające z zaistnienia tzw. siły wyższej. O stwierdzonych brakach ilościowych w opakowaniach należy powiadomić VALVEX nie później niż 14 dni roboczych od otrzymania dostawy zarówno w przypadku wysyłek spedycyjnych, jak i wysyłki transportem Valvex. Zgłoszenie reklamacji ilościowej winno być wystawione na papierze firmowym (lub opatrzone pieczęcią nagłówkową firmy reklamującej), zawierając krótką informację o liczbie sztuk wyrobów brakujących, z każdego opakowania oddzielnie, wraz z podaniem stanu technicznego opakowania (uszkodzone, dziurawe, otwarte, niezaplombowane, bez metki itp.), nr katalogowy, nr faktury zakupowej, datę i miejsce stwierdzenia niezgodności. Metki z każdego opakowania, w którym stwierdzono niedobór, wraz ze zgłoszeniem Odbiorca wysłać na adres VALVEX listem poleconym po uprzednim zgłoszeniu faxem lub e-mailem. VALVEX po ewentualnym uznaniu reklamacji wystawi fakturę korygującą lub jeżeli jest to możliwe, uzupełni niedobór w sposób fizyczny. VALVEX przyjmuje obowiązek załatwienia reklamacji ilościowej w ciągu 30 dni.

Wszelkie reklamacje ilościowe strony trzeciej są wykluczone.

Okres oraz warunki gwarancji na poszczególne wyroby Valvex są ściśle określone w kartach gwarancyjnych, dostępnych na [www.valvex.com](http://www.valvex.com).

W trakcie promocji okresy gwarancyjne mogą ulec zmianie, co zostanie potwierdzone w odpowiednich dokumentach gwarancyjnych.

VALVEX będzie, według swego wyboru, wymieniać lub naprawiać wyroby lub ich części, które w okresie trwania gwarancji, licząc od dnia przeniesienia odpowiedzialności, stały się bezużyteczne, lub których użyteczność została znacznie ograniczona na skutek okoliczności pochodzącej sprzed momentu przeniesienia odpowiedzialności, obciążającej VALVEX, a w szczególności na skutek wadliwej konstrukcji, wad materiałowych lub wadliwego wykonania. Wymienione wadliwe wyroby lub ich części pozostają własnością VALVEX. Wybór sposobu wykonania gwarancji należy do VALVEX.

Odpowiedzialność za wady z tytułu gwarancji nie obejmuje naturalnego zużycia oraz wad, których przyczyną nie są zależności od VALVEX (użytkowanie niezgodne z przeznaczeniem, błąd projektowy instalacji, praca powyżej parametrów dopuszczalnych, uszkodzenia mechaniczne, uszkodzenia spowodowane brakiem lub nieodpowiednią konserwacją i dbałością o czystość wyrobu, uszkodzenia spowodowane montażem niezgodnym z instrukcją, uszkodzeń spowodowanych działaniem tzw. siły wyższej oraz wynikających z naturalnego zużycia elementów wyrobu). Samodzielne usuwanie wad przez Zamawiającego / Użytkownika dopuszczalne jest tylko w przypadkach wyjątkowych (np. zagrożenie bezpieczeństwa). W przypadkach takich należy niezwłocznie informować VALVEX.

Decyzja o uznaniu roszczeń z tytułu wad i braków podejmowana jest przez służbę kontroli jakości VALVEX. Kupujący obowiązany jest umożliwić VALVEX usunięcie wad w sposób wskazany powyżej. Jeżeli tego odmawia, VALVEX zwolniony jest z obowiązku usunięcia wad. Żądania wykraczające poza opisany zakres są wykluczone. Wyklucza się również zmiany w samej umowie kupna-sprzedaży, takie jak obniżenie ceny, wypowiedzenie umowy lub wycofanie się z niej.

Wszelkie reklamacje jakościowe winny być składane w formie pisemnej. Zgłoszenie reklamacji musi zawierać dane użytkownika, dokładny opis identyfikujący wyrób oraz zgłoszoną usterkę, kserokopię dokumentu potwierdzającego zakup. Dla wyrobów posiadających indywidualne karty gwarancyjne konieczne jest również przedstawienie wypełnionej i podpisanej przez sprzedającego takiej karty wraz z wpisaną czytelnie datą zakupu, zgodną z przedstawionym dokumentem zakupu.

Wszystkie wyroby VALVEX powinny być zainstalowane zgodnie z przeznaczeniem i zasadami montażu. VALVEX nie ponosi odpowiedzialności za żadne szkody wynikające z niewłaściwego montażu, a przede wszystkim spowodowane montażem uniemożliwiającym łatwy, bezkolizyjny dostęp do wyrobu.

Wyroby lub ich elementy mogą być przesłane producentowi do naprawy jedynie za jego pisemną zgodą oraz na jego koszt, tylko i wyłącznie poprzez wskazanego przez producenta przewoźnika. Przesłanie przesyłki poprzez przewoźnika innego niż wskazany przez producenta może spowodować odmowę odebrania przesyłki lub obciążenie jej kosztami nadawcy. Przesyłki muszą być odpowiednio opisane i właściwie zapakowane, tzn. w sposób uniemożliwiający powstanie dodatkowych uszkodzeń w trakcie załadunku, transportu i rozładunku oraz spełniać podstawowe wymagania higieniczne.

VALVEX przyjmuje obowiązek zajęcia stanowiska w sprawie reklamacji jakościowej w ciągu 14 dni od otrzymania wadliwego wyrobu lub pisemnego zgłoszenia. VALVEX zastrzega sobie prawo wprowadzania zmian i ulepszeń technicznych wyrobów bez uprzedzenia.

Ponadto Valvex posiada liczne certyfikaty wyrobów i aprobaty techniczne wydane przez polskie i zagraniczne jednostki certyfikujące. Państwowy Zakład Higieny - PZH, Instytut Techniki Budowlanej - ITB, Instytutu Nafty i Gazu - INiG, Laboratoria CARSO-ACS - Francja, TSU - Słowacja, laboratorium DBI-DVGW - Niemcy, URBAN INCERC - Rumunia to instytucje, w których badano nasze produkty. Posiadamy dokumenty dopuszczające do sprzedaży w Uni Europejskiej, Białorusi, Rosji i Ukrainie.





---

**VALVEX S.A.**

ul. Nad Skawą 2  
34-240 Jordanów, Poland

Tel.: +48 18 269 32 20

Fax: +48 18 269 32 11

e-mail: [valvex@valvex.com](mailto:valvex@valvex.com)

**[www.valvex.com](http://www.valvex.com)**