



VALVEX[™]
Power of Quality

BATHROOMS



SAVE MONEY



MIXER/CERAMIC HEAD



EASY FIX



AERATING STREAM
REGULATOR



EASY CLEAN



ADJUSTABLE DIRECTION
OF WATER FLOW



LOW FLOW



COMFORT ZONE



ROTATIONAL SPOUT



LOCK
DIVERTER



PRESSURE
DIVERTER



CERAMIC
DIVERTER



AUTOMATIC
POP-UP DRAIN



DRAIN ASSEMBLY
WITH PULLING ROD

SAVE MONEY

Save Water & Money.
The faucet aerator with the SAVE MONEY system reduces the flow of water up to 8 l / min., regardless of water pressure.

EASY FIX

EASY FIX is an innovative system for easy installation that is used in single-handle faucets by VALVEX. It significantly reduces the installation time.

EASY CLEAN

The faucet aerator is equipped with EASY-CLEAN technology with an antiscaling system and a rubber finish which makes it resistant to scaling and easy to clean and maintain.

AERATING STREAM REGULATOR

Aerator with adjustable stream direction it allows adjustment of the angle of water outflow in the range of 7 degrees in any direction.

COMFORT ZONE

The high spout creates a comfort zone for the user, ensuring maximum freedom of use of the mixer.

BATHROOMS



That, what surrounds us, reflects your true nature. Feel the inspiration on our everyday life and create a timeless oasis of comfort. Do you desire harmony at your home? Therefore, make sure that your interior is unique, atmospheric and functional, and at the same time it

Enjoy it ...



Discover the
hypnotic

MIKADO 

aerator stream

Turn ordinary handwashing into a delightful experience with the MIKADO Perlator.

Using single water streams, it creates a unique geometric pattern, thanks to which it saves water (flow only 1.9 l / min), without sacrificing your comfort. MIKADO is an innovative aerator that will surely enchant you, and your hands will provide unprecedented sensations: from gently pleasant to energetically massaging.





HARMONY
OF SHAPES

SERIES OF **AURORA**

The unique form of the mixer will give the classic spaces a completely new, expressive face.



Washbasin mixer with pop-up drain
2445100

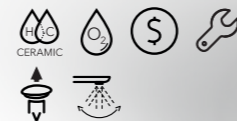

EASY INSTALLATION



EASY FIX is an innovative system for easy installation that significantly reduces the installation time.



Washbasin high mixer
2445110
2445117



Wall mounted bath mixer
2445130



Wall mounted shower mixer
2445140



Concealed shower mixer
2445160



Concealed bathtub and shower mixer tap
2445170



Bidet mixer with manual pop-up drain
2445120





UNIQUE
CHARACTER



SERIES OF **AURORA** Rose Gold

An intriguing shape, cleverly smuggled subtle design and color will charm your senses and delight with originality.



Washbasin mixer
with pop-up drain
2445200



DURABLE COATING

The ROSE GOLD coating is created by PVD technology. Its main features are hardness and durability for mechanical damage.



Washbasin high
mixer
2445210
2445217



Wall mounted
bath mixer
2445230



Wall mounted
shower mixer
2445240



Concealed shower
mixer
2445260



Concealed bathtub
and shower mixer tap
2445270



Bidet mixer with
manual pop-up drain
2445220





THE BEAUTY
OF GEOMETRY

SERIES OF QUASAR

A clear line and strong outlines will make the room will acquire a unique character.



Washbasin mixer with pop-up drain
2446800

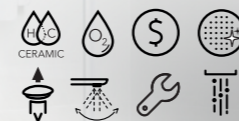

SAVING
LOW-FLOW aerator limiting water consumption up to 4.5 l / min, it's simultaneously environmentally friendly and good for your budget.



Washbasin high mixer
2446810
2446817



Wall mounted bath mixer
2446830



Wall mounted shower mixer
2446840



Concealed shower mixer
2446860



Concealed bathtub and shower mixer tap
2446870



Bidet mixer with manual pop-up drain
2446820





THE MAGIC
OF SYMMETRY

SERIES OF DALI

Slender shapes, without any sharp angles and hard edges, bring to mind the masterpieces of the surrealist painters.



Washbasin mixer
with pop-up drain
2447200

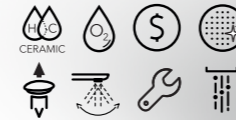

ECONOMY

Perlator limiting water consumption to 8 l / min, regardless of the water pressure.



Washbasin high
mixer

2447210

2447217



Wall mounted
bath mixer

2447230



Wall mounted
shower mixer

2447240



Concealed shower
mixer

2447260



Concealed bathtub
and shower mixer tap

2447270



Bidet mixer with
manual pop-up drain

2447220





NOBLE
BLACK



SERIES OF **DALI** Black

The most classic and elegant color combination, constantly present in interior design trends.



Washbasin mixer
with pop-up drain
2447900

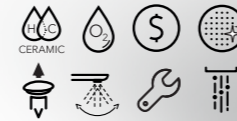

EASY CLEAN

The aerator is equipped with EASY-CLEAN technology with a rubber finish, making it resistant to limescale deposits and easy to clean and maintain.



Washbasin high mixer

2447910
2447917



Wall mounted bath mixer

2447930



Wall mounted shower mixer

2447940



Concealed shower mixer

2447960



Concealed bathtub and shower mixer tap

2447970



Bidet mixer with manual pop-up drain

2447920





MODERN
INTERPRETATION
OF CLASSIC



SERIES OF **DALI** White

A combination of colors and materials that perfectly harmonize with modern design.



Washbasin mixer
with pop-up drain
2447300



CLICK-CLACK SYSTEM

Click-clack system is a convenient opening and closing of the outflow without having to pull out the whole plug or use additional mechanisms.



Washbasin high
mixer
2447310
2447317



Wall mounted
bath mixer
2447330



Wall mounted
shower mixer
2447340



Concealed shower
mixer
2447360



Concealed bathtub
and shower mixer tap
2447370



Bidet mixer with
manual pop-up drain
2447320





SERIES OF VEGANE

AURA
OF HARMONY

A perfect combination of design, functionality, energy efficiency and exceptional durability.



Washbasin mixer with manual pop-up drain

2422750



Washbasin high mixer

2422770



Wall mounted bath mixer

2422890



Wall mounted shower mixer

2422870



Bidet mixer with manual pop-up drain

2422850



FUNCTIONALITY



Drain assembly with pulling rod is equipped with a mechanism that allows opening and closing the drain without the need to dip your hands in water.

SERIES OF VEGANE

MODERN
DESIGN

An ideal proposition for people who are attached to tradition, while keeping up with trends.



Wall mounted three-hole washbasin mixer

2422810



SMOOTH ADJUSTMENT



High-quality ceramic heads enable smooth and precise regulation of water flow. Everything is under control, in full harmony ...



Three hole washbasin mixer with manual pop-up drain

2422790



Five hole bath mixer with accessories

2422830





SERIES OF **VEGANE** Nero

BLACK
LUXURY

Deep, dull black closed in a fresh, minimalistic form of the mixer.



Washbasin mixer with pop-up drain

2423310

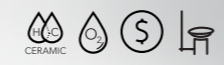

ECOLOGY



The economical aerator is equipped with a mechanism that mixes the outgoing water with the air. This simple solution gives noticeable savings in consumption, which reach up to 50%.



Washbasin high mixer

2423330

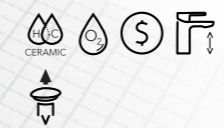

Wall mounted bath mixer

2423390



Wall mounted shower mixer

2423370



Bidet mixer with manual pop-up drain

2423350



SERIES OF **VEGANE** Bianco

GRACE
OF COLOR

Perfectly fits with the colors,
intriguing with the matt, structural
coating. Precision in every inch.

Washbasin mixer
with pop-up drain

2423300



DESIGN

The simple form gives rhythm and provides harmony
while the white finish of the mixer soothes the senses.



Washbasin high
mixer

2423320



Wall mounted
bath mixer

2423380



Wall mounted
shower mixer

2423360



Bidet mixer with
manual pop-up drain

2423340





POWER OF
POSSIBILITIES

SERIES OF LOFT

Smooth lines, simple and geometric shapes, chrome finish and attention to every detail.



LOFT ECO

Washbasin mixer with pop-up drain

2454900



EASY CLEAN

Just wipe the rubber finish with your finger to eliminate the dirt. Aerator with EASY CLEAN system provides an even stream of water without any splashes and retains its full efficiency for longer.



Washbasin mixer

2454910



Washbasin high mixer (239 mm)

2454920



Washbasin high mixer (270 mm)

2454730



Concealed wall-mounted basin mixer

2454780

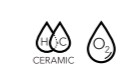

Wall mounted bath mixer

2454930



Wall mounted shower mixer

2454940





MODERN
FUNCTIONALITY

SERIES OF **LOFT**

Smooth lines, simple and geometric shapes, chrome finish and attention to every detail.

DESIGN

The 4-hole bath mixer is practical and convenient to use. Separately mounted: spout, shower head, handle and switch perfectly fit into modern arrangements.

Four hole bath mixer with accessories

2454890

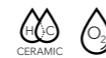

Wall mounted shower mixer with upper connection

2455760



Concealed shower mixer

2454970



Concealed bathtub and shower mixer tap

2454980



3-function concealed mixer

2408660



Bidet mixer with manual pop-up drain

2454950



COMING
SOON



COMPLETE
CHARACTER

The unusual structural coat
of the mixer catches the eye,
making the interior unique.

FUNCTIONALITY



Adjustable direction of
water flow ensures precise
adaptation of the flow
to your own needs, which
is important especially
for large washbasins.

Washbasin mixer
with pop-up drain

2455900



SERIES OF **LOFT** Black

DESIGN

The individual elements of the mixer, connected with
each other in an invisible way to the user, create an
impressive bathroom decoration. The swivel spout
and retractable shower hose ensure full freedom of
movement during bathing.

Four hole bath mixer
with accessories

2455950



Washbasin high
mixer

2455910



Wall mounted
bath mixer

2455920



Wall mounted
shower mixer

2455930



Concealed shower
mixer

2455960



Concealed bathtub
and shower mixer tap

2455970



Bidet mixer with
manual pop-up drain

2455940



COMING
SOON



TIMELESS
WHITE

Universal, timeless white,
economical style, moderation.
Classy mixers.

SAVING



Aerator limiting water
consumption to 8 l / min,
regardless of water
pressure.

Washbasin mixer
with pop-up drain

2456500



SERIES OF **LOFT** White

SMOOTH REGULATION



The high-class ceramic head enables smooth and precise water flow regulation. Everything is under control, in full harmony ...

Four hole bath mixer
with accessories

2456550



Washbasin high
mixer

2456510



Wall mounted
bath mixer

2456520



Wall mounted
shower mixer

2456530



Concealed shower
mixer

2456560



Concealed bathtub
and shower mixer tap

2456570



Bidet mixer with
manual pop-up drain

2456540





GREAT VIBE

SERIES OF **LOFT Gold**

A composition full of splendor will delight anyone who will have the pleasure of meeting it ...



Washbasin mixer with pop-up drain
2455800



Wall mounted bath mixer
2455810



Wall mounted shower mixer
2455820



SAVING

The LOW-FLOW aerator, which reduces water consumption by up to 4.5 l / min, is environmentally friendly and good for your wallet.

DURABLE COATING

The GOLD coating is created by PVD technology. Its main features are hardness and resistance to mechanical damage.



INSPIRE
BY NATURE

SERIES OF TUBE

Symphony of shapes emerges
in the form of a subtle, but
decisive form.



TUBE ECO
Washbasin mixer
with pop-up drain
2454800



Washbasin mixer
with pop-up drain
2454810



Washbasin high
mixer
2454820



Wall mounted
bath mixer
2454830



Wall mounted
shower mixer
2454840



Wall mounted shower
mixer with upper conection
2455720



FUNCTIONALITY

The movable disc of the aerator makes it possible
to adjust the angle of the stream to the dimen-
sions of the basin.



SUBTLETY
OF SHAPES

SERIES OF
TUBE

The perfection of the solids is combined with the perfection of action.

ECOLOGY



The economical aerator is equipped with a mechanism that mixes the outgoing water with the air. This simple solution gives noticeable savings in consumption, which reach up to 50%.



Concealed wall-mounted basin mixer

2454790



Concealed shower mixer

2454870



Concealed bathtub and shower mixer tap

2454880



3-function concealed mixer

2408640



Bidet mixer with manual pop-up drain

2454850



SERIES OF SIGMA

ENERGY
THAT DELIGHT

Captivating, endearing, energetic ... Full functionality closed in perfect form.



Washbasin mixer
with pop-up drain
2456100

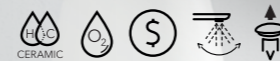

CLICK-CLACK SYSTEM

Click-clack system is a convenient opening and closing of the outflow without having to pull out the whole plug or use additional mechanisms.



Washbasin high
mixer
2456140



Wall mounted
bath mixer
2456110



Wall mounted
shower mixer
2456120



Concealed shower
mixer
2456160



Concealed bathtub
and shower mixer tap
2456160





THE ART
OF COMFORT

SERIES OF **LORI**

Born from a pure love of beauty
and functional solutions ...
An interesting mix of classics
with a bit of madness.



Washbasin mixer
with pop-up drain
2456200

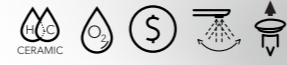

Washbasin high
mixer
2456240



Wall mounted
bath mixer
2456210



Wall mounted
shower mixer
2456220



Concealed shower
mixer
2456250



Concealed bathtub
and shower mixer tap
2456260



ECOLOGY

Save water and money - the aerator with the SAVE MONEY system reduces water flow up to 8 l / min. regardless of water pressure.



EXCEPTIONAL
EVERYDAY

SERIES OF ANGELO

Simple and solid construction, ensuring trouble-free operation for many years. An excellent choice for lovers of convenience and minimalist solutions.



Washbasin mixer with manual pop-up drain
2453000



FUNCTIONALITY

Drain assembly with pulling rod is equipped with a mechanism that allows opening and closing the drain without the need to dip your hands in water.



Wall mounted bath mixer
2453010



Wall mounted shower mixer
2453020



Bidet mixer with manual pop-up drain
2453050



Concealed shower mixer
2453260



Concealed bathtub and shower mixer tap
2453270





UNLIMITED
EXPERIENCE

SERIES OF ESTILL

The FIXED TEMPERATURE system protects us against sudden changes of water temperature. This small, great solution makes your showering an unforgettable and uninterrupted experience.

SAFETY



The innovative COLD TOUCH system ensures that the robust brass body of the spray faucet always remains cool and safe.

Thermostatic mixer
for shower
2447170



ECO & SAVING

When using the ESTILL thermostatic mixer, you do not waste time setting the right temperature. You do not lose any more liters of water, or the next kilowatts used to heat too hot water.



Thermostatic mixer
for shower
2447150



Thermostatic mixer
for bathtub
2447160

TECHNICAL DATA

AURORA



Washbasin mixer

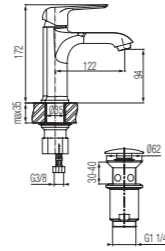

Code: Chrome	2445100	2445101
Code: Rose Gold	2445200	2445201
Cartridge	Ø35	
Flow class	Z	
Hoses / Connection	G 3/8	G 1/2
Net weight	1142 g	

AURORA



Washbasin high mixer

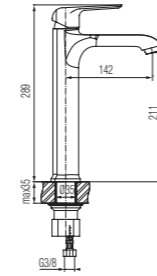

Code: Chrome	2445110	2445111	2445117
Code: Rose Gold	2445210	2445211	2445217
Cartridge	Ø35		
Flow class	Z		
Hoses/conn.	G 3/8	G 1/2	G 3/8
Net weight	1815 g		

QUASAR



Washbasin high mixer

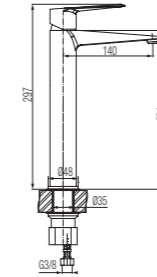

Code	2446810	2446811	2446817
Cartridge	Ø35		
Flow class	Z		
Hoses/Conn.	G 3/8	G 1/2	G 3/8
Net weight	1640 g		
Finish	Chrome		

QUASAR



Bidet mixer

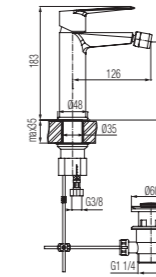

Code	2446820	2446821
Cartridge	Ø35	
Flow class	A	
Hoses / Connection	G 3/8	G 1/2
Net weight	1276 g	
Finish	Chrome	

QUASAR



Wall mounted bath mixer

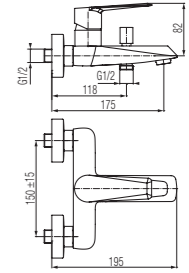

Code	2446830
Cartridge	Ø35
Flow class	B/B
Hoses / Connection	G 1/2
Net weight	1296 g
Finish	Chrome

AURORA



Bidet mixer

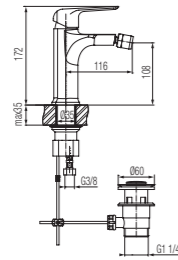

Code: Chrome	2445120	2445121
Code: Rose Gold	2445220	2445221
Cartridge	Ø35	
Flow class	A	
Hoses / Connection	G 3/8	G 1/2
Net weight	1289 g	

AURORA



Wall mounted bath mixer

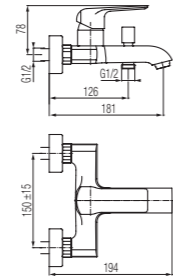

Code: Chrome	2445130
Code: Rose Gold	2445230
Cartridge	Ø35
Flow class	B/B
Hoses / Connection	G 1/2
Net weight	1318 g

AURORA



Wall mounted shower mixer

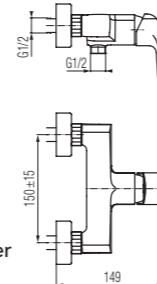

Code: Chrome	2445140
Code: Rose Gold	2445240
Cartridge	Ø35
Flow class	B
Hoses / Connection	G 1/2
Net weight	1238 g

QUASAR



Wall mounted shower mixer

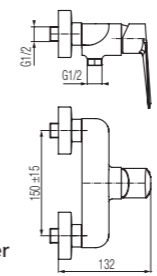

Code	2446840
Cartridge	Ø35
Flow class	B
Hoses / Connection	G 1/2
Net weight	1265 g
Finish	Chrome

QUASAR



Concealed shower mixer

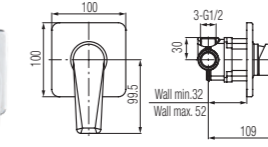

Code	2446860
Cartridge	Ø35
Flow class	B
Hoses / Connection	3-G 1/2
Net weight	947 g
Finish	Chrome

QUASAR



Concealed bathtub and shower mixer tap

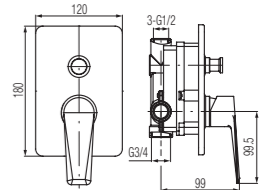

Code	2446870
Cartridge	Ø35
Flow class	B/B
Hoses / Connection	in 2-G 1/2, out 1-G 1/2, 1-G 3/4
Net weight	1447 g
Finish	Chrome

AURORA

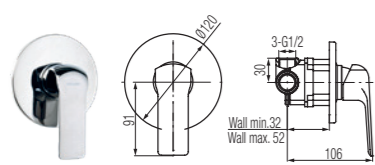

Concealed shower mixer

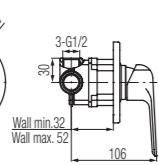

Code: Chrome	2445160
Code: Rose Gold	2445260
Cartridge	Ø35
Flow class	B
Hoses / Connection	3-G 1/2
Net weight	947 g

AURORA



Concealed bathtub and shower mixer tap

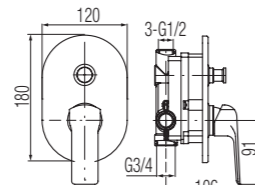

Code: Chrome	2445170
Code: Rose Gold	2445270
Cartridge	Ø35
Flow class	B/B
Hoses / Connection	in 2-G 1/2, out 1-G 1/2, 1-G 3/4
Net weight	1447 g

QUASAR



Washbasin mixer

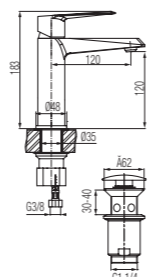

Code	2446800	2446801
Cartridge	Ø35	
Flow class	Z	
Hoses / Connection	G 3/8	G 1/2
Net weight	1095 g	
Finish	Chrome	

DALI



Washbasin mixer

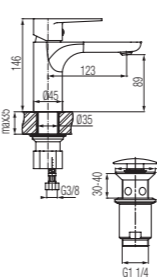

Code: Chrome	2447200	2447201
Code: White / Chrome	2447300	2447301
Code: Black / Chrome	2447900	2447901
Cartridge	Ø35	
Flow class	Z	
Hoses / Connection	G 3/8	G 1/2
Net weight	1291 g	

DALI



Washbasin high mixer

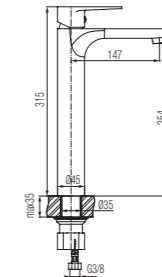

Code: Chrome	2447210	2447211	2447217
Code: White/Chrome	2447310	2447311	2447317
Code: Black/Chrome	2447910	2447911	2447917
Cartridge	Ø35		
Flow class	Z		
Hoses / Connection	G 3/8	G 3/8	G 1/2
Net weight	1699 g		

DALI



Bidet mixer

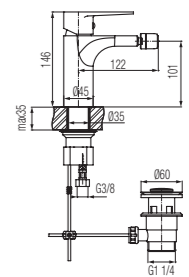

Code: Chrome	2447220	2447221
Code: White / Chrome	2447320	2447321
Code: Black / Chrome	2447920	2447921
Cartridge	Ø35	
Flow class	A	
Hoses / Connection	G 3/8	G 1/2
Net weight	1366 g	

DALI



Wall mounted bath mixer

Code: Chrome	2447230
Code: White / Chrome	2447330
Code: Black / Chrome	2447930
Cartridge	Ø35
Flow class	B/B
Hoses / Connection	G 1/2
Net weight	1570 g

DALI



Wall mounted shower mixer

Code: Chrome	2447240
Code: White / Chrome	2447340
Code: Black / Chrome	2447940
Cartridge	Ø35
Flow class	B
Hoses / Connection	G 1/2
Net weight	1278 g

DALI

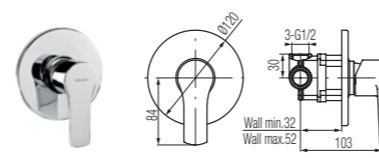

Concealed shower mixer

Code: Chrome	2447260
Code: White / Chrome	2447360
Code: Black / Chrome	2447960
Cartridge	Ø35
Flow class	B
Hoses / Connection	3-G 1/2
Net weight	947 g

DALI

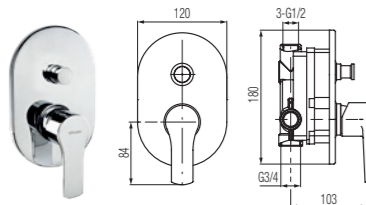

Concealed bathtub and shower mixer tap

Code: Chrome	2447270
Code: White/Chrome	2447370
Code: Black/Chrome	2447970
Cartridge	Ø35
Flow class	B/B
Hoses / Connection	in 2-G 1/2, out 1-G1/2, 1-G3/4
Net weight	1447 g

VEGANE

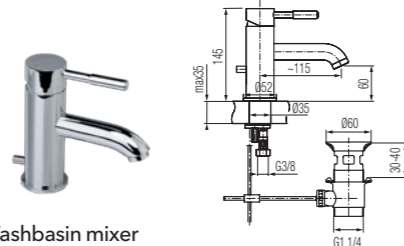

Washbasin mixer

Code: Chrome	2422750	2422650
Code: Bianco	2423300	2423700
Code: Nero	2423310	2423710
Cartridge	Ø35	
Flow class	Z	
Hoses / Connection	G 3/8	G 1/2
Net weight	1697 g	

VEGANE

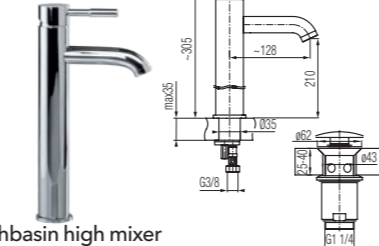

Washbasin high mixer

Code: Chrome	2422770	2422660
Code: Bianco	2423320	2423720
Code: Nero	2423330	2423730
Cartridge	Ø35	
Flow class	Z	
Hoses / Connection	G 3/8	G 1/2
Net weight	2365 g	

VEGANE

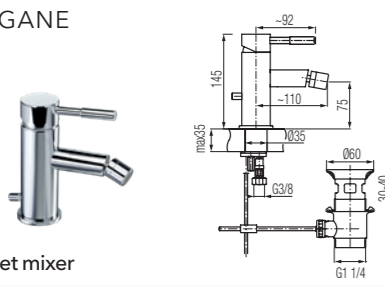

Bidet mixer

Code: Chrome	2422850	2422670
Code: Bianco	2423340	2423740
Code: Nero	2423350	2423750
Cartridge	Ø35	
Flow class	A	
Hoses / Connection	G 3/8	G 1/2
Net weight	1628 g	

VEGANE

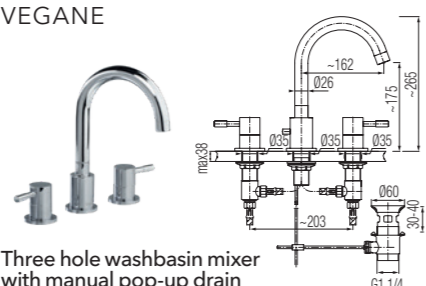

Three hole washbasin mixer with manual pop-up drain

Code: Chrome	2422790
Cartridge	głowica ceramiczna
Flow class	A
Hoses / Connection	G3/8
Net weight	3133 g

VEGANE



Five hole bath mixer with accessories

Code: Chrome	2422830
Cartridge	głowica ceramiczna
Flow class	B/A
Hoses / Connection	G3/8
Net weight	4399 g

VEGANE

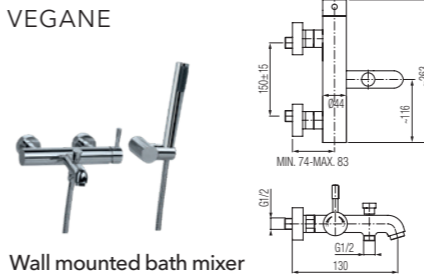

Wall mounted bath mixer

Code: Chrome	2422890
Code: Bianco	2423380
Code: Nero	2423390
Cartridge	Ø35
Flow class	S/A
Hoses / Connection	G 1/2
Net weight	2707 g

VEGANE

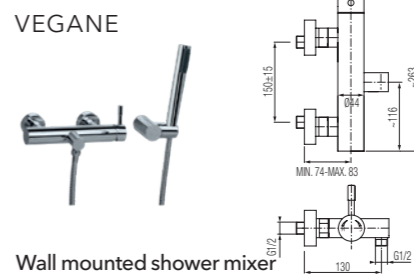

Wall mounted shower mixer

Code: Chrome	2422870
Code: Bianco	2423360
Code: Nero	2423370
Cartridge	Ø35
Flow class	A
Hoses / Connection	G 1/2
Net weight	2584 g

LOFT ECO



Washbasin mixer

Code: Chrome	2454900	2454901
Code: Black	2455900	---
Code: White	2456500	---
Code: Gold	2455800	---
Cartridge	Ø35	
Flow class	Z	
Hoses / Connection	G 3/8	G 1/2
Net weight	1217 g	

LOFT

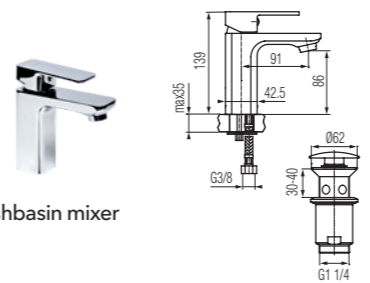

Washbasin mixer

Code: Chrome	2454910	2454911
Cartridge	Ø35	
Flow class	A	
Hoses / Connection	G 3/8	G 1/2
Net weight	1217 g	

LOFT

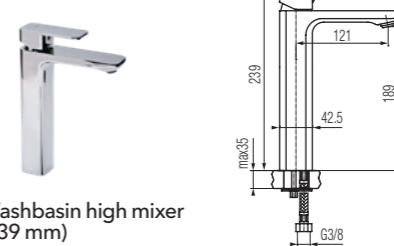

Washbasin high mixer (239 mm)

Code: Chrome	2454920	2454921
Cartridge	Ø35	
Flow class	Z	
Hoses / Connection	G 3/8	G 1/2
Net weight	1545 g	

LOFT

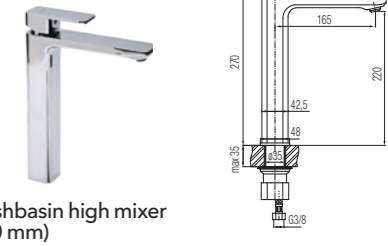

Washbasin high mixer (270 mm)

Code: Chrome	2454730
Code: Black	2455910
Code: White	2456510
Cartridge	Ø35
Flow class	Z
Hoses / Connection	G 3/8
Net weight	1652 g

LOFT

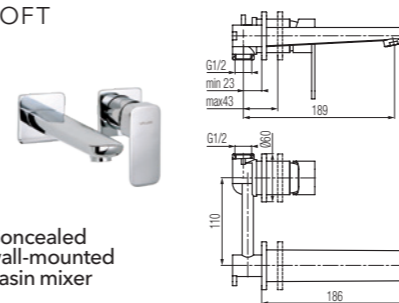

Concealed wall-mounted basin mixer

Code: Chrome	2454780
Cartridge	Ø35
Flow class	A
Hoses / Connection	G1/2
Net weight	1491 g

LOFT

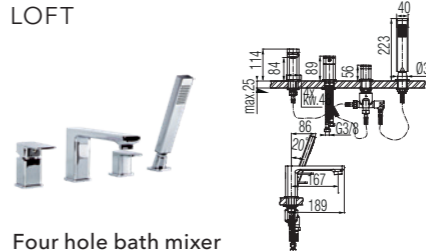

Four hole bath mixer

Code: Chrome	2454890
Code: Black	2455950
Code: White	2456550
Cartridge	Ø35
Flow class	B/Z
Hoses / Connection	G 3/8
Net weight	4180 g

LOFT

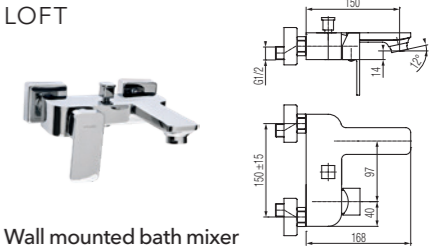

Wall mounted bath mixer

Code: Chrome	2454930
Code: Black	2455920
Code: White	2456520
Code: Gold	2455810
Cartridge	Ø35
Flow class	B/B
Hoses / Connection	G 1/2
Net weight	1847 g

LOFT



Wall mounted shower mixer

Code: Chrome	2454940
Code: Black	2455930
Code: White	2456530
Code: Gold	2455810
Cartridge	Ø35
Flow class	B
Hoses / Connection	G 1/2
Net weight	1305 g

LOFT

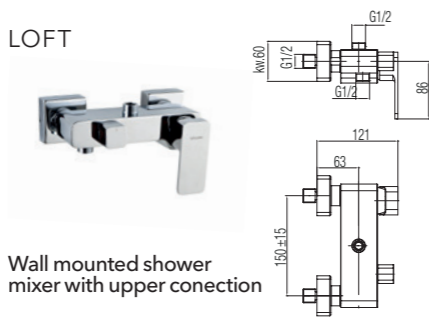

Wall mounted shower mixer with upper conection

Code: Chrome	2455760
Cartridge	Ø35
Flow class	A/A
Hoses / Connection	G 1/2
Net weight	1520 g

LOFT

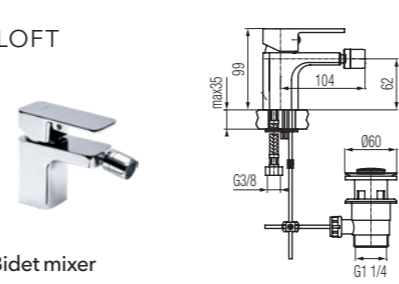

Bidet mixer

Code: Chrome	2454950	2454951
Code: Black	2455940	---
Code: White	2456540	---
Cartridge	Ø35	
Flow class	Z	
Hoses / Connection	G 3/8	G 1/2
Net weight	1242 g	

TUBE



Wall mounted shower mixer

Code: Chrome	2454840
Cartridge	Ø35
Flow class	B
Hoses / Connection	G 1/2
Net weight	1075 g

TUBE

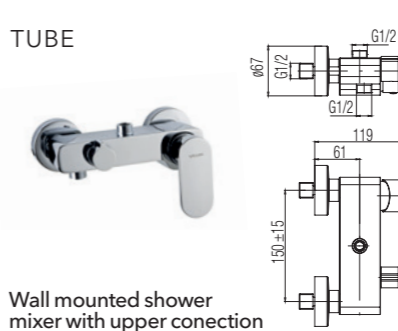

Wall mounted shower mixer with upper conection

Code: Chrome	2455720
Cartridge	Ø35
Flow class	A/A
Hoses / Connection	G 1/2
Net weight	1490 g

TUBE

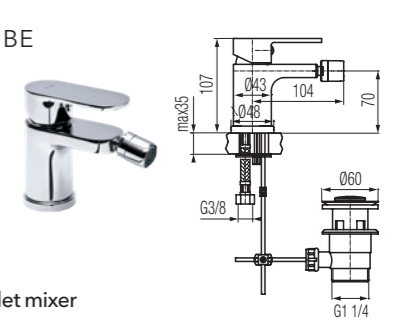

Bidet mixer

Code: Chrome	2454850	2454830
Cartridge	Ø35	
Flow class	Z	
Hoses / Connection	G 3/8	G 1/2
Net weight	1137 g	

LOFT

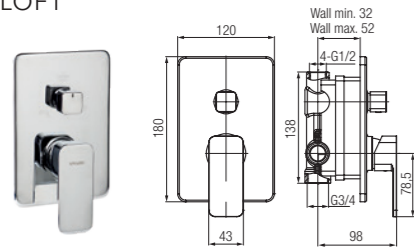

3-function concealed mixer

Code: Chrome	2408660
Cartridge	Ø35
Flow class	B/B/B
Hoses / Connection	G 1/2 x G3/4
Net weight	1585 g

TUBE ECO



Washbasin mixer

Code: Chrome	2454800	2454801
Cartridge	Ø35	
Flow class	Z	
Hoses / Connection	G 3/8	G 1/2
Net weight	920 g	

TUBE

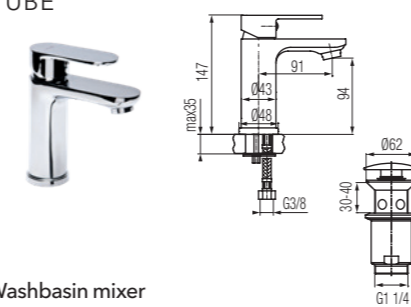

Washbasin mixer

Code: Chrome	2454810	2454811
Cartridge	Ø35	
Flow class	A	
Hoses / Connection	G 3/8	G 1/2
Net weight	920 g	

TUBE

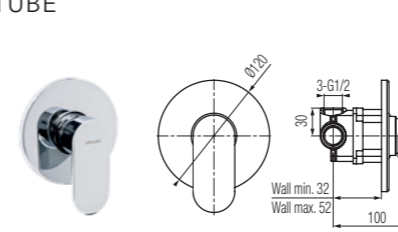

Concealed shower mixer

Code: Chrome	2454870
Cartridge	Ø35
Flow class	A
Hoses / Connection	G 1/2
Net weight	1075 g

TUBE

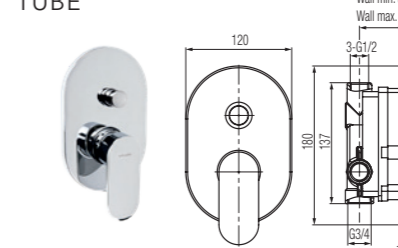

Concealed bathtub and shower mixer tap

Code: Chrom	2454880
Cartridge	Ø35
Flow class	B/B
Hoses / Connection	in 2-G 1/2, out 1-G1/2, 1-G3/4
Net weight	1447 g

TUBE

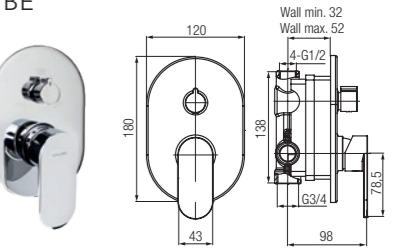

3-function concealed mixer

Code: Chrome	2408640
Cartridge	Ø35
Flow class	B/B/B
Hoses / Connection	G 1/2 x G3/4
Net weight	1513 g

TUBE

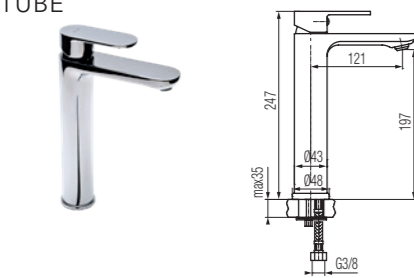

Washbasin high mixer

Code: Chrome	2454820	2454830
Cartridge	Ø35	
Flow class	Z	
Hoses / Connection	G 3/8	G 1/2
Net weight	1300 g	

TUBE

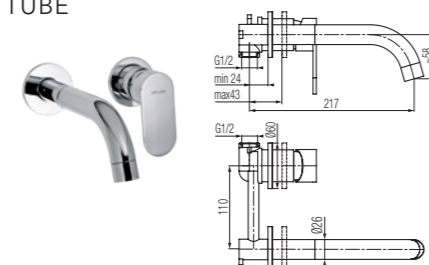

Concealed wall-mounted basin mixer

Code: Chrome	2454790
Cartridge	Ø35
Flow class	A
Hoses / Connection	G1/2
Net weight	1271 g

TUBE

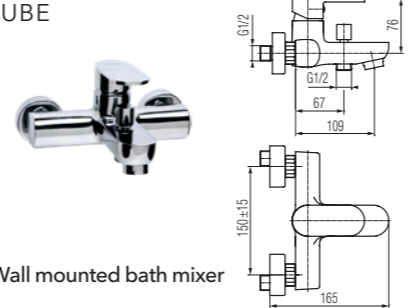

Wall mounted bath mixer

Code: Chrome	2454830
Cartridge	Ø35
Flow class	B/B
Hoses / Connection	G 1/2
Net weight	1410 g

SIGMA

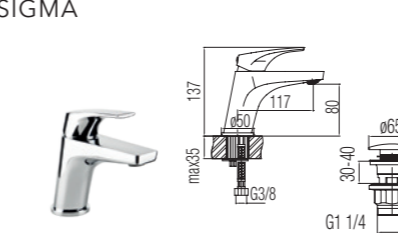

Washbasin mixer

Code: Chrome	2456100
Cartridge	Ø35
Flow class	Z
Hoses / Connection	G 3/8
Net weight	1260 g

SIGMA



Washbasin high mixer

Code: Chrome	2456140
Cartridge	Ø35
Flow class	Z
Hoses / Connection	G 3/8
Net weight	1640 g

SIGMA

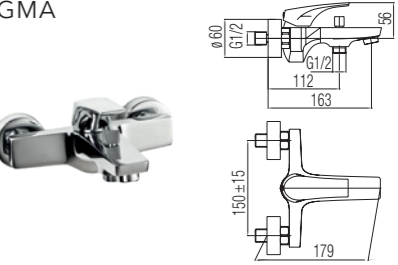

Wall mounted bath mixer

Code: Chrome	2456110
Cartridge	Ø35
Flow class	A/B
Hoses / Connection	G 1/2
Net weight	1480 g

SIGMA

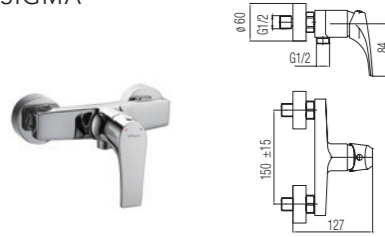

Wall mounted shower mixer

Code: Chrome	2456120
Cartridge	Ø35
Flow class	B
Hoses / Connection	G 1/2
Net weight	1080 g

SIGMA

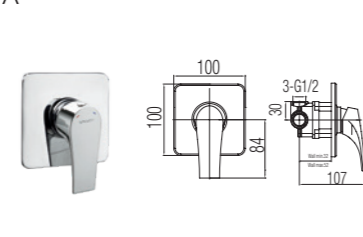

Concealed shower mixer

Code: Chrome	2456160
Cartridge	Ø35
Flow class	B
Hoses / Connection	3-G 1/2
Net weight	927 g

SIGMA

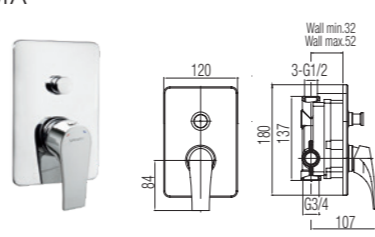

Concealed bathtub and shower mixer tap

Code: Chrome	2456170
Cartridge	Ø35
Flow class	B/B
Hoses / Connection	in 2-G 1/2, out 1-G1/2, 1-G3/4
Net weight	1496 g

LORI

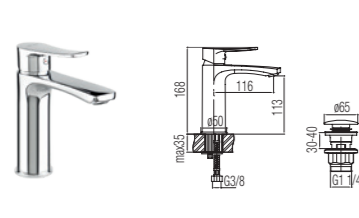

Washbasin mixer

Code: Chrome	2456200
Cartridge	Ø35
Flow class	Z
Hoses / Connection	G 3/8
Net weight	1340 g

LORI

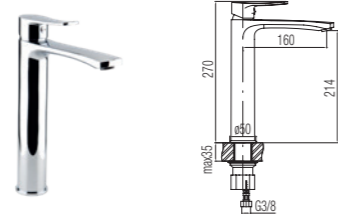

Washbasin high mixer

Code: Chrome	2456240
Cartridge	Ø35
Flow class	Z
Hoses / Connection	G 3/8
Net weight	1260 g

LORI

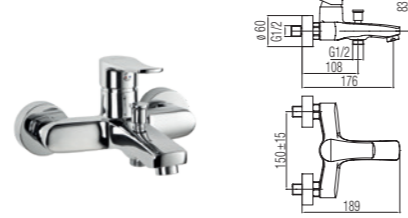

Wall mounted bath mixer

Code: Chrome	2456210
Cartridge	Ø35
Flow class	A/B
Hoses / Connection	G 1/2
Net weight	1410 g

LORI



Wall mounted shower mixer

Code: Chrome	2456220
Cartridge	Ø35
Flow class	B
Hoses / Connection	G 1/2
Net weight	1080 g

LORI

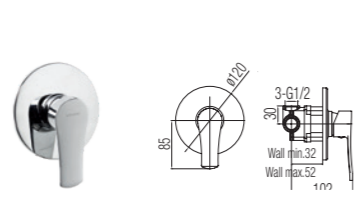

Concealed shower mixer

Code: Chrome	2456250
Cartridge	Ø35
Flow class	B
Hoses / Connection	3-G 1/2
Net weight	893 g

LORI

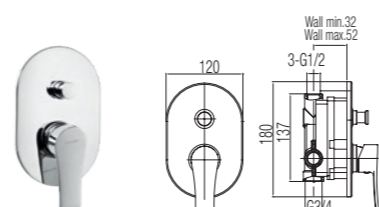

Concealed bathtub and shower mixer tap

Code: Chrome	2456260
Cartridge	Ø35
Flow class	B/B
Hoses / Connection	in 2-G 1/2, out 1-G1/2, 1-G3/4
Net weight	893 g

ANGELO

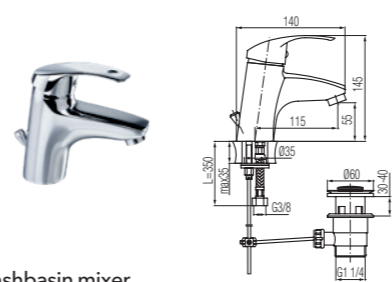

Washbasin mixer

Code: Chrome	2453000	2453300
Cartridge	Ø40	
Flow class	S	
Hoses / Connection	G 3/8	G 1/2
Net weight	1582 g	

ANGELO

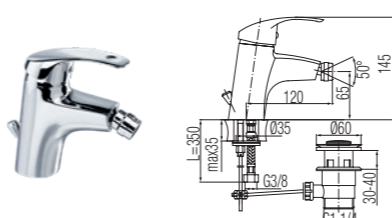

Bidet mixer

Code: Chrome	2453050	2453350
Cartridge	Ø40	
Flow class	S	
Hoses / Connection	G 3/8	G 1/2
Net weight	1454 g	

ESTILL ROUND PLUS



Thermostatic mixer for shower

Code: Chrome	2447150
Cartridge	głowica termostatyczna
Flow class	B
Hoses / Connection	G 1/2
Net weight	1580 g

ANGELO

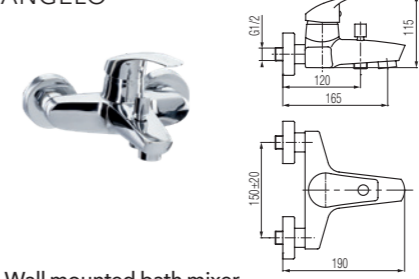

Wall mounted bath mixer

Code: Chrome	2453010
Cartridge	Ø40
Flow class	B/B
Hoses / Connection	G 1/2
Net weight	1603 g

ANGELO



Concealed shower mixer

Code: Chrome	2453270
Cartridge	Ø35
Flow class	B
Hoses / Connection	3-G 1/2
Net weight	930 g

ESTILL ROUND

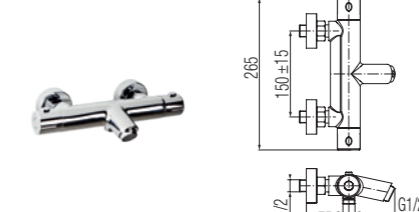

Thermostatic mixer for bathtub

Code: Chrome	2447160
Cartridge	głowica termostatyczna
Flow class	B/C
Hoses / Connection	G 1/2
Net weight	1850 g

ANGELO



Wall mounted shower mixer

Code: Chrome	2453020
Cartridge	Ø40
Flow class	B
Hoses / Connection	G 1/2
Net weight	1200 g

ANGELO

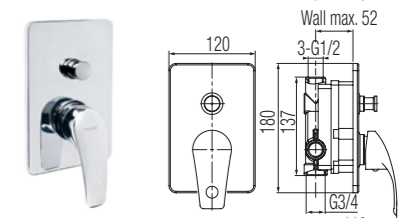

Concealed bathtub and shower mixer tap

Code: Chrome	2453280
Cartridge	Ø35
Flow class	B/B
Hoses / Connection	in 2-G 1/2, out 1-G1/2, 1-G3/4
Net weight	1500 g

ESTILL SQUARE PLUS

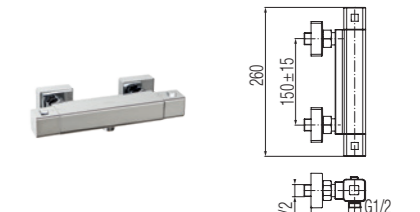

Thermostatic mixer for shower

Code: Chrome	2447170
Cartridge	głowica termostatyczna
Flow class	B
Hoses / Connection	G 1/2
Net weight	1880 g



VALVEX SA

ul. Nad Skawą 2
34-240 Jordanów
POLAND

tel.: +48 18 269 32 20
mail: valvex@valvex.com
www.valvex.com

9999527
release date: 08.2019