

ARMATURA INSTALACYJNA



VALVEX™



MOC TECHNOLOGII
SIŁA INNOWACJI



ARMATURA
SANITARNA



INSTALACJE



TECHNIKA
GRZEWCZA

POLSKI
PRODUCENT

jest znakiem zastrzeżonym Valvex S.A. i podlega ochronie prawnej. Wszelkie jego powielanie, kopiowanie lub używanie w jakikolwiek inny sposób bez zgody Valvex S.A. jest zabronione. Valvex S.A. zastrzega, że wygląd produktów przedstawionych na zdjęciach może nieznacznie odbiegać od wyglądu rzeczywistego produktów.

ARMATURA INSTALACYJNA

SYMBOLE

25 lat gwarancji
Udzielamy 25-letniej gwarancji na elementy odlewane i kute.

10 lat gwarancji

5 lat gwarancji

2 lata gwarancji

Serwis 48h
Gwarancja usługi serwisowej w 48h.

Ekologia
Posiadamy ISO 14001, nasze technologie i produkty są przyjazne dla środowiska.

Jakość
Posiadamy ISO 9001, nasze produkty wyróżniają się najwyższą jakością.



Sprężone powietrze

Glikol

Instalacje solarne

Antyalergiczny system - wszystkie elementy zaworu mające styczność z wodą, nie są pokryte niklem

Głowica ceramiczna

Głowica suwakowa

Metalowa dźwignia

Bezpieczeństwo przeciwpożarowe

Instalacje grzewcza / wentylacyjna / klimatyzacyjna

Łączność bezprzewodowa

SPIS TREŚCI

ARMATURA INSTALACYJNA WODNA 6

ONYX, TRYTON, ORO, OLIGO,
VIKING, OMNI, OPTI, MINI,
PURE, ERGO, VEGA, TRANGLE,
STRIT, STAR, EKO, EKO PLUS,
ANGEL PLUS, BASE, PROFF,
OPAL, TIGER, TIGER PLUS,
CETUS

WEŻYKI PRZYŁĄCZENIOWE 20

VIPER PLUS

ARMATURA INSTALACYJNA GAZOWA 24

4TECH
ORION
V-GAS

ARMATURA INSTALACYJNA CENTRALNEGO OGRZEWANIA 28

THERMO, IRIS, FUSION, VELA, VECTOR, VIRGO,
THERMO SET, VECTOR MAX, FUSION 3, THERMO
PLUS, VECTOR LUX, ACTIV PLUS, ACTIV, ALFA, BETA,
GAMMA, PIZA, PROFF, BASE, PROFF MIX, PROFF CO,
COMBI, V-THERM, FEST, BYPASS, SECURE, DIRECT,
MINI, VISION, COPPER, PEX, PEX-AL, MICRA, SUBER,
AXE, VIRGO, PROTECTIVE CAP, VELA

SYSTEMY INSTALACYJNE – ZŁĄCZKI DO RUR STALOWYCH 54

TWIST

SYSTEMY INSTALACYJNE – ZŁĄCZKI DO RUR PE-X/AL/PE-X 62

V-PEX

1. ONYX - PN 40-30 / 180°C
Kurek kulowy pełnoprzelotowy z dławikiem z dźwignią stalową, wersja nakrętno-nakrętna

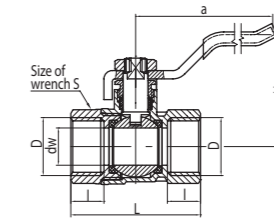

DN	Kod	Wymiar	Wymiary								P nom. / max temp.	Ilość szt.	Opakow.	Waga netto	Kod	Cena
			D	I	dw	L	a	H	S	S1						
10	1451320	3/8"	G3/8	10	10	41,5	90	40	21	PN 40 / 180°C	96/16	P-1	0,1360	1451320	18,60 zł	
15	1452320	1/2"	G1/2	12	13,5	47	90	42	25	PN 40 / 180°C	72/12	P-1	0,1573	1452320	21,50 zł	
20	1453320	3/4"	G3/4	12	18,5	55	90	46	31	PN 40 / 180°C	60/10	P-1	0,2268	1453320	32,50 zł	
25	1454320	1"	G1	14,5	23,5	65	110	50	38	PN 40 / 180°C	36/6	P-1	0,3503	1454320	50,10 zł	
32	1455320	1 1/4"	G1 1/4	15	30	75	115,5	65	48	PN 30 / 180°C	24/6	P-1	0,5706	1455320	84,70 zł	
40	1456320	1 1/2"	G1 1/2	16	37	84	140	82,5	54	PN 30 / 180°C	8/2	P-1	0,9462	1456320	126,50 zł	
50	1457320	2"	G2	18	47	100	140	90	67	PN 30 / 180°C	8/2	P-1	1,4225	1457320	195,70 zł	

2. ONYX - PN 16 / 95°C
Kurek kulowy pełnoprzelotowy z dławikiem z dźwignią stalową, wersja nakrętno-nakrętna

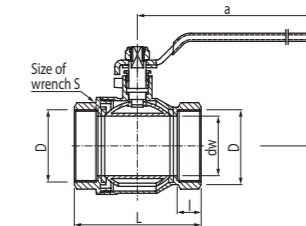

DN	Kod	Wymiar	Wymiary								P nom. / max temp.	Ilość szt.	Opakow.	Waga netto	Kod	Cena
			D	I	dw	L	a	H	S	S1						
65	9007930	2 1/2"	G2 1/2	24	62	136	236	110	82	PN 16 / 95°C	4	P-24	2,547	9007930	399,20 zł	
80	9007920	3"	G3	26	74	150	236	119	93	PN 16 / 95°C	3	P-24	3,753	9007920	553,90 zł	
100	9007910	4"	G4	28	85	172	240	136	120	PN 16 / 95°C	2	P-24	5,616	9007910	900,90 zł	

3. ONYX - PN 40 / 180°C
Kurek kulowy pełnoprzelotowy z dławikiem z motylikiem aluminiowym (MAI), wersja nakrętno-nakrętna

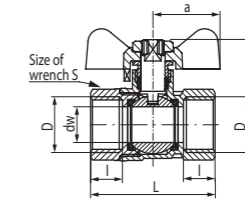

DN	Kod	Wymiar	Wymiary								P nom. / max temp.	Ilość szt.	Opakow.	Waga netto	Kod	Cena
			D	I	dw	L	a	H	S	S1						
15	1452400	1/2"	G1/2	12	13,5	47	25	36	25	PN 40 / 180°C	84/14	P-1	0,132	1452400	21,50 zł	
20	1453400	3/4"	G3/4	12	18,5	55	25	40	31	PN 40 / 180°C	72/12	P-1	0,200	1453400	32,50 zł	
25	1454400	1"	G1	14,5	23,5	65	32,5	47	38	PN 40 / 180°C	48/8	P-1	0,316	1454400	50,10 zł	

4. ONYX - PN 40 / 180°C
Kurek kulowy pełnoprzelotowy z dławikiem z półśrubunkiem z dźwignią stalową

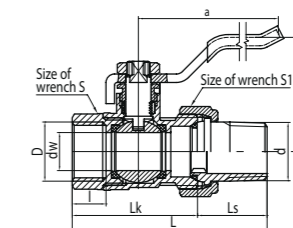

DN	Kod	Wymiar	Wymiary											P nom. / max temp.	Ilość szt.	Opakow.	Waga netto	Kod	Cena
			D	I	dw	L	Lk	d	a	H	S	S1	S1						
15	1452420	1/2"	G1/2	12	13,5	69	44,5	R1/2	90	42	25	30	PN 40 / 180°C	60/10	P-1	0,210	1452420	35,50 zł	
20	1453420	3/4"	G3/4	12	18,5	77,5	55	R3/4	90	46	31	37	PN 40 / 180°C	36/6	P-1	0,311	1453420	51,70 zł	
25	1454420	1"	G1	14,5	23,5	88,5	58,5	R1	110	50	38	46	PN 40 / 180°C	24/4	P-1	0,482	1454420	77,10 zł	

5. ONYX - PN 40 / 180°C
Kurek kulowy pełnoprzelotowy z dławikiem z półśrubunkiem z motylikiem aluminiowym (MAI)

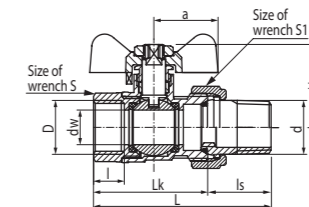

DN	Kod	Wymiar	Wymiary											P nom. / max temp.	Ilość szt.	Opakow.	Waga netto	Kod	Cena
			D	I	dw	L	Lk	d	a	H	S	S1	S1						
15	1452440	1/2"	G1/2	12	13,5	69	44,5	R1/2	25	36,5	25	30	PN 40 / 180°C	60/10	P-1	0,184	1452440	35,50 zł	
20	1453440	3/4"	G3/4	12	18,5	77,5	55	R3/4	25	40	31	37	PN 40 / 180°C	36/6	P-1	0,281	1453440	51,70 zł	
25	1454440	1"	G1	14,5	23,5	88,5	58,5	R1	32,5	50	38	46	PN 40 / 180°C	24/4	P-1	0,461	1454440	75,40 zł	



6. ONYX - PN 30-40 / 180°C
Kurek kulowy pełnoprzelotowy z dławikiem z dźwignią stalową, wersja nakrętno-wkrętna

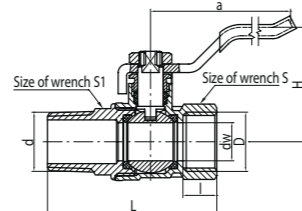

DN	Kod	Wymiar	D	I	dw	L	d	a	H	S	S1	P nom. / max temp.	Ilość szt	Opakow.	Waga netto	Kod	Cena
10	1451460	3/8"	G3/8	10	10	50,5	R3/8	90	40	21	18	PN 40 / 180°C	96/16	P-1	0,142	1451460	23,20 zł
15	1452460	1/2"	G1/2	12	13,5	60	R1/2	90	42	25	22	PN 40 / 180°C	72/12	P-1	0,169	1452460	26,60 zł
20	1453460	3/4"	G3/4	12	18,5	68	R3/4	90	46	31	28	PN 40 / 180°C	60/10	P-1	0,245	1453460	37,30 zł
25	1454460	1"	G1	14,5	23,5	79	R1	110	50	38	35	PN 40 / 180°C	36/6	P-1	0,381	1454460	56,50 zł
32	1455460	1 1/4"	G1 1/4	15	30	93	R1 1/4	115,5	65	48	44	PN 30 / 180°C	24/6	P-1	0,571	1455460	94,50 zł
40	1456460	1 1/2"	G1 1/2	16	37	104	R1 1/2	140	82,5	54	52	PN 30 / 180°C	8/2	P-1	0,946	1456460	144,70 zł
50	1457460	2"	G2	18	47	120	R2	140	90	67	63	PN 30 / 180°C	8/2	P-1	1,423	1457460	220,30 zł

7. ONYX - PN 40 / 180°C
Kurek kulowy pełnoprzelotowy z dławikiem z motykiem aluminiowym (MAI), wersja nakrętno-wkrętna

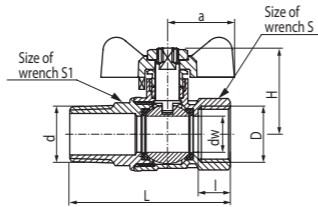

DN	Kod	Wymiar	D	I	dw	L	d	a	H	S	S1	P nom. / max temp.	Ilość szt	Opakow.	Waga netto	Kod	Cena
10	1451480	3/8"	G3/8	10	10	50,5	R3/8	25	34	21	18	PN 40 / 180°C	108/18	P-1	0,114	1451480	23,20 zł
15	1452480	1/2"	G1/2	12	13,5	60	R1/2	25	36	25	22	PN 40 / 180°C	72/12	P-1	0,146	1452480	26,60 zł
20	1453480	3/4"	G3/4	12	18,5	68	R3/4	25	40	31	28	PN 40 / 180°C	60/10	P-1	0,222	1453480	37,30 zł
25	1454480	1"	G1	14,5	23,5	79	R1	32,5	47	38	35	PN 40 / 180°C	36/6	P-1	0,357	1454480	56,50 zł

8. ONYX - PN 40 / 180°C
Kurek kulowy pełnoprzelotowy z dławikiem z dźwignią stalową, wersja wkrętno-wkrętna

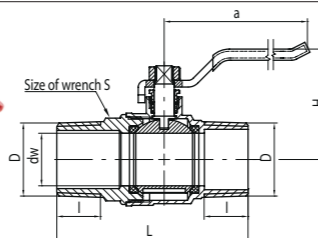
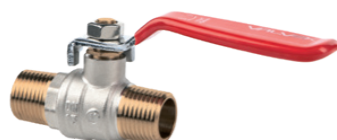

DN	Kod	Wymiar	D	I	dw	L	a	H	S	P nom. / max temp.	Ilość szt	Opakow.	Waga netto	Kod	Cena
15	1452470	1/2"	R1/2	14,5	13,5	64	80	43	23	PN 40 / 180°C	50	P-1	0,169	1452470	27,20 zł
20	1453470	3/4"	R3/4	16,5	18,5	72,5	80	46	28	PN 40 / 180°C	25	P-1	0,236	1453470	37,90 zł
25	1454470	1"	R1	19,5	23,5	84	100	50	35	PN 40 / 180°C	15	P-1	0,378	1454470	57,20 zł

9. ONYX - PN 40 / 180°C
Kurek kulowy pełnoprzelotowy z dławikiem z motykiem aluminiowym (MAI), wersja wkrętno-wkrętna

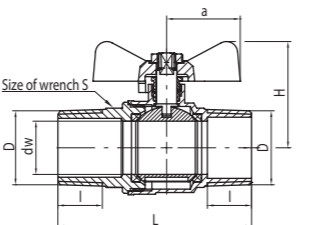

DN	Kod	Wymiar	D	I	dw	L	a	H	S	P nom. / max temp.	Ilość szt	Opakow.	Waga netto	Kod	Cena
15	1452430	1/2"	R1/2	14,5	13,5	64	25	37	23	PN 40 / 180°C	50	P-1	0,142	1452430	27,20 zł
20	1453430	3/4"	R3/4	16,5	18,5	72,5	25	40	28	PN 40 / 180°C	30	P-1	0,210	1453430	37,90 zł
25	1454430	1"	R1	19,5	23,5	84	32,5	47	35	PN 40 / 180°C	15	P-1	0,340	1454430	57,20 zł

10. ONYX BASE
Zawór z półrubunkiem i uszczelnieniem EPDM do rozdzielaczy

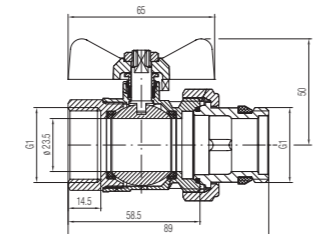

Kod	P nom.	Temp. nom.	Ilość szt.	Opakow.	Waga netto	Kod	Cena
1454140	PN 10	95°C	4 / 24	P-1472.60/1 / P-1472.60/2	0,473	1454140	72,90 zł

11. SPIN
Odcinający zawór kulowy z obrotową nakrętką z dźwignią stalową

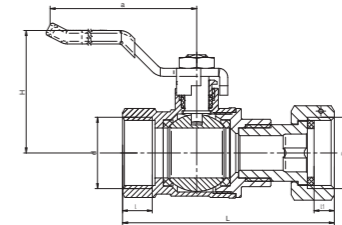

DN	Kod	d	D	dw	L	a	H	I	II	P nom. / max temp.	Ilość szt	Opakow.	Waga netto	Kod	Cena
15	1472900	1/2"	G1/2	13,5	65,5	90	42	12	6	PN 25 / 95°C	20	P-1	0,240	1472900	30,30 zł
15	1472940	1/2"	G3/4	13,5	71	90	42	12	7,5	PN 25 / 95°C	20	P-1	0,240	1472940	31,30 zł
20	1473900	3/4"	G3/4	18,5	78,5	90	46	12	7,5	PN 25 / 95°C	20	P-1	0,325	1473900	33,90 zł
20	1473940	3/4"	G1	18,5	79,5	90	46	12	7,5	PN 25 / 95°C	15	P-1	0,345	1473940	34,50 zł

12. SPIN
Odcinający zawór kulowy z obrotową nakrętką z motykiem aluminiowym (MAI)

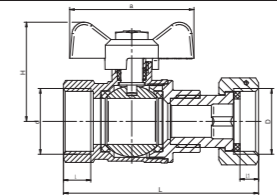

DN	Kod	d	D	dw	L	a	H	I	II	P nom. / max temp.	Ilość szt	Opakow.	Waga netto	Kod	Cena
15	1472920	1/2"	G1/2	13,5	65,5	90	37	12	6	PN 25 / 95°C	20	P-1	0,240	1472920	30,30 zł
15	1472960	1/2"	G3/4	13,5	71	90	37	12	7,5	PN 25 / 95°C	20	P-1	0,200	1472960	31,30 zł
20	1473920	3/4"	G3/4	18,5	78,5	90	40	12	7,5	PN 25 / 95°C	20	P-1	0,288	1473920	33,90 zł
20	1473960	3/4"	G1	18,5	79,5	90	40	12	7,5	PN 25 / 95°C	15	P-1	0,310	1473960	34,50 zł

III kw. 2019

13. TRYTON - PN 40 / 140°C - PN 25 / 120°C
Kurek kulowy pełnoprzelotowy z dławikiem z dźwignią stalową, wersja nakrętno-nakrętna

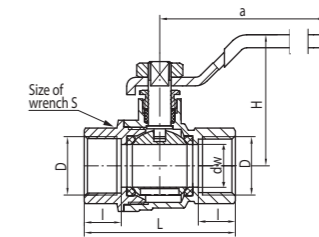

DN	Kod	Wymiar	D	I	dw	L	a	H	S	P nom. / max temp.	Ilość szt	Opakow.	Waga netto	Kod	Cena
10	1451200	3/8"	G3/8	12	10	45	80	44	20	PN 40 / 140°C	16	P-43	0,130	1451200	23,80 zł
15	1452200	1/2"	G1/2	13	15	53	90	46	25	PN 40 / 140°C	12	P-1	0,201	1452200	31,30 zł
20	1453200	3/4"	G3/4	15	20	60	100	59	31	PN 40 / 140°C	10	P-1	0,296	1453200	48,80 zł
25	1454200	1"	G1	16	25	70	115	61	40	PN 40 / 140°C	6	P-1	0,501	1454200	74,50 zł
32	1455200	1 1/4"	G1 1/4	18	32	84	122	73	48	PN 30 / 120°C	4	P-1	0,777	1455200	121,50 zł
40	1456200	1 1/2"	G1 1/2	19	40	94	140	79	55	PN 25 / 120°C	2	P-1	1,092	1456200	166,20 zł
50	1457200	2"	G2	19	50	105	140	98	66	PN 25 / 120°C	3	P-1	1,445	1457200	249,30 zł

14. TRYTON - PN 40 / 140°C
Kurek kulowy pełnoprzelotowy z dławikiem z motykiem aluminiowym (MAI), wersja nakrętno-nakrętna

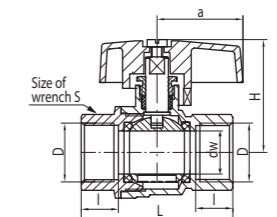

DN	Kod	Wymiar	D	I	dw	L	a	H	S	P nom. / max temp.	Ilość szt	Opakow.	Waga netto	Kod	Cena
15	1452210	1/2"	G1/2	13	15	53	30	42	25	PN 40 / 140°C	14	P-1	0,177	1452210	31,30 zł
20	1453150	3/4"	G3/4	15	20	60	40	47	31	PN 40 / 140°C	12	P-1	0,262	1453150	48,80 zł
25	1454150	1"	G1	16	25	70	40	50	40	PN 40 / 140°C	8	P-1	0,449	1454150	74,50 zł

15. TRYTON - PN 40 / 140°C
Kurek kulowy pełnoprzelotowy z dławikiem z półrubunkiem z dźwignią stalową

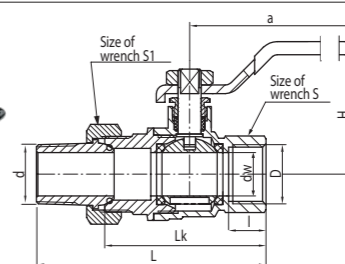

DN	Kod	Wymiar	D	I	dw	L	Lk	d	a	H	S	S1	P nom. / max temp.	Ilość szt	Opakow.	Waga netto	Kod	Cena
15	1452180	1/2"	G1/2	13	15	80	56	R1/2	90	46	25	30	PN 40 / 140°C	10	P-1	0,273	1452180	53,50 zł
20	1453180	3/4"	G3/4	15	20	88	62	R3/4	100	59	31	37	PN 40 / 140°C	6	P-1	0,396	1453180	74,70 zł
25	1454180	1"	G1	16	25	99	71	R1	115	61	40	47	PN 40 / 140°C	4	P-1	0,662	1454180	122,50 zł

16. TRYTON - PN 40 / 140°C
Kurek kulowy pełnoprzelotowy z dławikiem z półsrubunkiem z motykiem aluminiowym (MA)

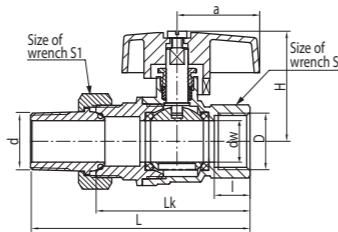

DN	Kod	Wymiar	D	I	dw	L	a	H	S	S1	P nom. / max temp.	Ilość szt	Opakow.	Waga netto	Kod	Cena		
15	1452190	1/2"	G1/2	13	15	80	56	R1/2	30	42	25	30	PN 40 / 140°C	10	P-1	0,244	1452190	52,40 zł
20	1453190	3/4"	G3/4	15	20	88	62	R3/4	40	47	31	37	PN 40 / 140°C	6	P-1	0,362	1453190	74,70 zł
25	1454190	1"	G1	16	25	99	71	R1	40	50	40	47	PN 40 / 140°C	4	P-1	0,615	1454190	122,50 zł

17. TRYTON - PN 40 / 140°C
Kurek kulowy pełnoprzelotowy z dławikiem z dźwignią stalową, wersja nakrętno-wkrętna

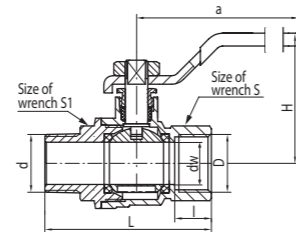

DN	Kod	Wymiar	D	I	dw	L	a	H	d	S	S1	P nom. / max temp.	Ilość szt	Opakow.	Waga netto	Kod	Cena
10	1451160	3/8"	G3/8	12	10	50	80	44	R3/8	20	20	PN 40 / 140°C	16	P-43	0,140	1451160	27,00 zł
15	1452160	1/2"	G1/2	13	15	59	90	46	R1/2	25	25	PN 40 / 140°C	12	P-1	0,212	1452160	37,00 zł
20	1453160	3/4"	G3/4	15	20	65	100	59	R3/4	31	28	PN 40 / 140°C	10	P-1	0,296	1453160	54,20 zł
25	1454160	1"	G1	16	25	77	115	61	R1	40	39	PN 40 / 140°C	6	P-1	0,507	1454160	87,70 zł

18. TRYTON - PN 40 / 140°C
Kurek kulowy pełnoprzelotowy z dławikiem z motykiem aluminiowym (MA), wersja nakrętno-wkrętna

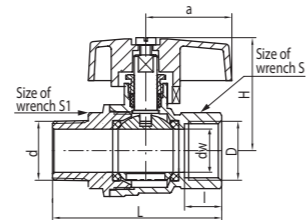

DN	Kod	Wymiar	D	I	dw	L	a	H	d	S	S1	P nom. / max temp.	Ilość szt	Opakow.	Waga netto	Kod	Cena
10	1451170	3/8"	G3/8	12	10	50	30	30	R3/8	20	20	PN 40 / 140°C	18	P-1	0,123	1451170	27,00 zł
15	1452170	1/2"	G1/2	13	15	59	30	42	R1/2	25	25	PN 40 / 140°C	12	P-1	0,186	1452170	37,00 zł
20	1453170	3/4"	G3/4	15	20	65	40	47	R3/4	31	28	PN 40 / 140°C	10	P-1	0,263	1453170	54,20 zł
25	1454170	1"	G1	16	25	77	40	50	R1	40	39	PN 40 / 140°C	6	P-1	0,461	1454170	87,70 zł

19. ORO - PN 16 / 120°C
Kurek kulowy z dławikiem z dźwignią stalową, wersja nakrętno-nakrętna

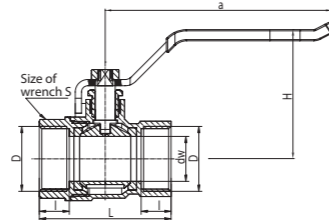

DN	Kod	Wymiar	D	I	dw	L	a	H	S	P nom. / max temp.	Ilość szt	Opakow.	Waga netto	Kod	Cena
15	1472600	1/2"	G1/2	11	13,5	45	90	49	24	PN 16 / 120°C	72/12	P-1	0,140	1472600	14,60 zł
20	1473600	3/4"	G3/4	12	18	53	90	52	30	PN 16 / 120°C	60/10	P-1	0,200	1473600	21,70 zł
25	1474600	1"	G1	14	22	62	110	59	37	PN 16 / 120°C	36/6	P-1	0,335	1474600	33,90 zł
32	1475600	1 1/4"	G1 1/4	15	27	71	110	65	46	PN 16 / 120°C	24/6	P-1	0,450	1475600	51,10 zł
40	1476600	1 1/2"	G1 1/2	16	34	81	140	78	52	PN 16 / 120°C	16/4	P-1	0,700	1476600	85,40 zł
50	1477600	2"	G2	21	43	101	140	85	68	PN 16 / 120°C	8/2	P-1	1,100	1477600	143,20 zł

20. ORO - PN 16 / 120°C
Kurek kulowy z dławikiem z motykiem aluminiowym (MA), wersja nakrętno-nakrętna

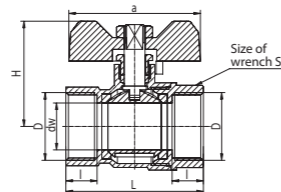

DN	Kod	Wymiar	D	I	dw	L	a	H	S	P nom. / max temp.	Ilość szt	Opakow.	Waga netto	Kod	Cena
15	1472620	1/2"	G1/2	11	13,5	45	50	38,5	24	PN 16 / 120°C	84/14	P-1	0,120	1472620	15,50 zł
20	1473620	3/4"	G3/4	12	18	53	50	40,5	30	PN 16 / 120°C	72/12	P-1	0,180	1473620	22,80 zł
25	1474620	1"	G1	14	22	62	63	49	37	PN 16 / 120°C	48/8	P-1	0,285	1474620	37,00 zł

21. ORO - PN 16 / 120°C
Kurek kulowy dławikiem z dźwignią stalową, wersja nakrętno-wkrętna

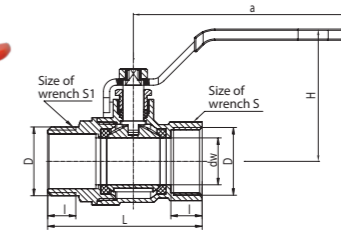

DN	Kod	Wymiar	D	I	dw	L	a	H	S	S1	P nom. / max temp.	Ilość szt	Opakow.	Waga netto	Kod	Cena
15	1472640	1/2"	G1/2	11	13,5	52	90	49	24	22	PN 16 / 120°C	72/12	P-1	0,145	1472640	19,10 zł
20	1473640	3/4"	G3/4	12	18	58	90	52	30	28	PN 16 / 120°C	60/10	P-1	0,210	1473640	26,20 zł
25	1474640	1"	G1	14	22	70	110	59	37	35	PN 16 / 120°C	36/6	P-1	0,360	1474640	43,50 zł

22. ORO - PN 16 / 120°C
Kurek kulowy z dławikiem z motykiem aluminiowym (MA), wersja nakrętno-wkrętna

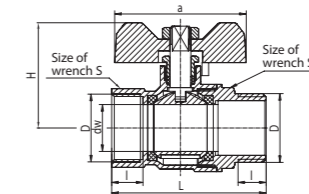

DN	Kod	Wymiar	D	I	dw	L	a	H	S	S1	P nom. / max temp.	Ilość szt	Opakow.	Waga netto	Kod	Cena
15	1472660	1/2"	G1/2	11	13,5	52	50	38,5	24	22	PN 16 / 120°C	72/12	P-1	0,125	1472660	17,00 zł
20	1473660	3/4"	G3/4	12	18	58	50	40,5	30	28	PN 16 / 120°C	60/10	P-1	0,190	1473660	23,10 zł
25	1474660	1"	G1	14	22	70	63	49	37	35	PN 16 / 120°C	36/6	P-1	0,310	1474660	38,60 zł

23. ORO - PN 16 / 120°C
Kurek kulowy pełnoprzelotowy z dławikiem z półsrubunkiem z motykiem aluminiowym (MA)

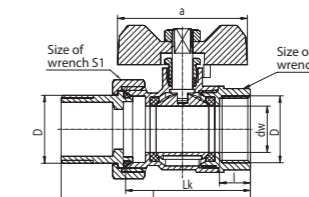

DN	Kod	Wymiar	D	I	dw	L	a	H	S	S1	P nom. / max temp.	Ilość szt	Opakow.	Waga netto	Kod	Cena	
15	1472680	1/2"	G1/2	11	13,5	62,5	40,5	50	38,5	24	29	PN 16 / 120°C	60/10	P-1	0,162	1472680	23,30 zł
20	1473680	3/4"	G3/4	12	18	73,5	48,5	50	40,5	30	37	PN 16 / 120°C	36/6	P-1	0,255	1473680	35,80 zł
25	1474680	1"	G1	14	22	85	57	63	49	37	47	PN 16 / 120°C	24/4	P-1	0,420	1474680	58,30 zł

24. OLIGO
Kurek kulowy czepalny z dławikiem z dźwignią stalową (DST)

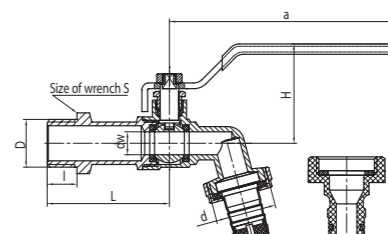
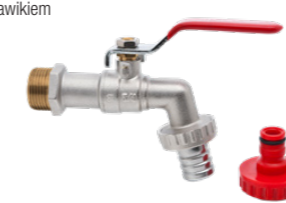

* Kurek kulowy 1" dostępny tylko z końcówką stalową

DN	Kod	Wymiar	D	I	dw	L	a	H	S	d	P nom. / max temp.	Ilość szt	Opakow.	Waga netto	Kod	Cena
15	1592200	1/2"	G1/2	13	10	54	92	44	24	G3/4	PN 10 / 65°C	100/10/1	P-1	0,190	1592200	24,60 zł
20	1593200	3/4"	G3/4	14	12,5	60	92	46	28	G1	PN 10 / 65°C	80/8/1	P-1	0,260	1593200	32,00 zł
25	1594200*	1"	G1	15	14,5	68	110	53	35	G1 1/4	PN 10 / 65°C	60/6/1	P-1	0,400	1594200*	50,20 zł

25. OLIGO
Kurek kulowy czepalny z dławikiem z motykiem aluminiowym (MA)

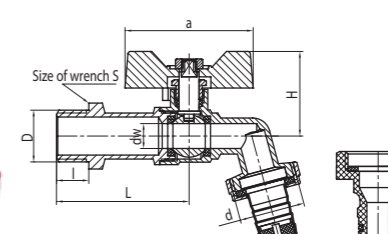

* Kurek kulowy 1" dostępny tylko z końcówką stalową

DN	Kod	Wymiar	D	I	dw	L	a	H	S	d	P nom. / max temp.	Ilość szt	Opakow.	Waga netto	Kod	Cena
15	1592100	1/2"	G1/2	13	10	54	52	34	24	G3/4	PN 10 / 65°C	100/10/1	P-1	0,190	1592100	24,60 zł
20	1593100	3/4"	G3/4	14	12,5	60	52	36	28	G1	PN 10 / 65°C	80/8/1	P-1	0,260	1593100	32,00 zł
25	1594100*	1"	G1	15	14,5	68	67	43	35	G1 1/4	PN 10 / 65°C	60/6/1	P-1	0,400	1594100*	50,20 zł

26. OLIGO DUO

Kurek kulowy czerpalny z dławikiem z dźwignią stalową oraz zaworem odcinającym

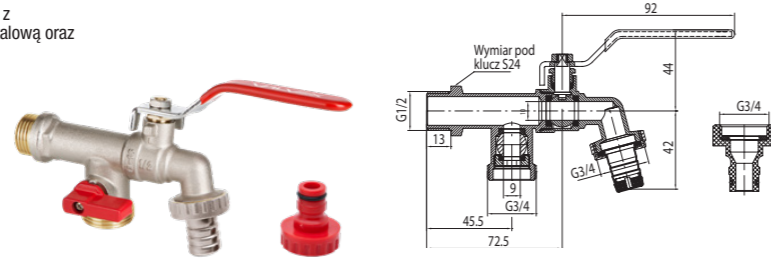

DN	Kod	P nom. / max temp.	Ilość szt	Opakow.	Waga netto	Kod	Cena
15	1592320	PN 10 / 65°C	80/8/1	P-1	0,296	1592320	49,90 zł

27. VIKING
Zawór wypływywowy żeliwny z końcówką do węża z szybkozłączem

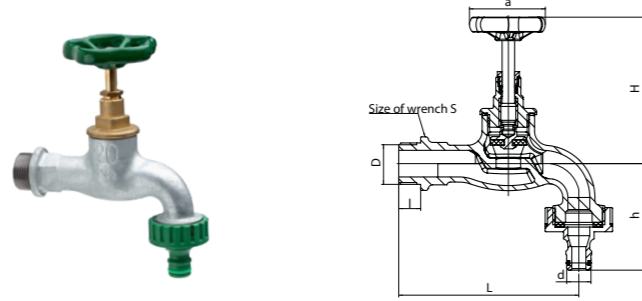

DN	Kod	Wymiary										P nom. / max temp.	Ilość szt	Opakow.	Waga netto	Kod	Cena
		Wymiar	D	I	L	a	H	h	d	S							
15	1292200	1/2"	G1/2	12	90	50	74-78	60	15,5	24	PN 10 / 65°C	6	P-1	0,369	1292200	43,50 zł	
20	1293200	3/4"	G3/4	14	115	50	85-93	68	15,5	24	PN 10 / 65°C	4	P-1	0,616	1293200	63,40 zł	

28. OMNI
Kurek kulowy spustowy z dźwignią aluminiową (DA) do podłączenia węża z szybkozłączem

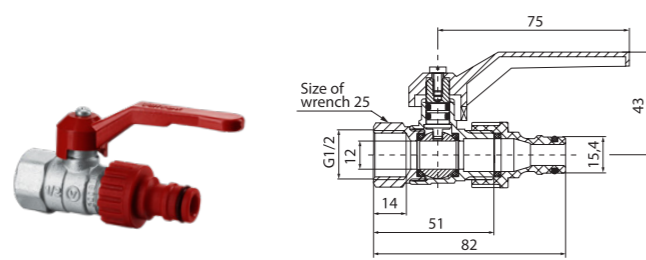

DN	Kod	Wymiar	P nom. / max temp.	Ilość szt	Opakow.	Waga netto	Kod	Cena
15	1582010	1/2"	PN 10 / 65°C	10	P-1	0,144	1582010	32,90 zł

29. OMNI
Kurek kulowy spustowy ze złączką do węża i zaślepką

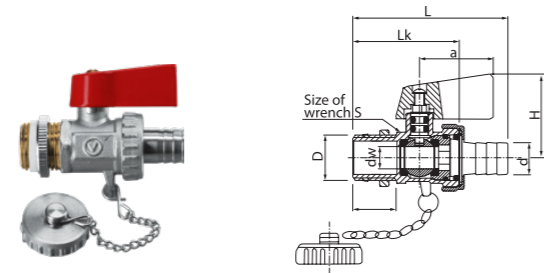

DN	Kod	Wymiary										P nom. / max temp.	Ilość szt	Opakow.	Waga netto	Kod	Cena
		Wymiar	D	I	dw	L	Lk	d	a	H	S						
15	1582280	1/2"	G1/2	15	10	72	50	15	34	35	23	PN 10 / 90°C	10	P-1	0,153	1582280	29,00 zł
20	1583280	3/4"	G3/4	17	15	84	55	20	34	40	30	PN 10 / 90°C	6	P-1	0,267	1583280	47,10 zł

30. OMNI
Kurek kulowy spustowy śrutowany ze złączką do węża i zaślepką

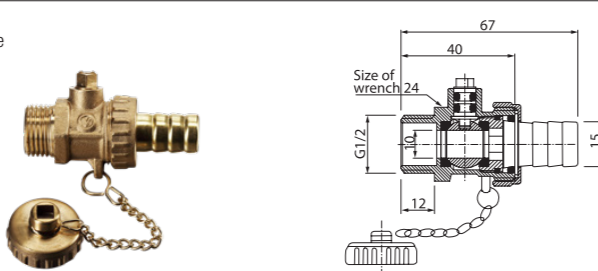

DN	Kod	Wymiar	P nom. / max temp.	Ilość szt	Opakow.	Waga netto	Kod	Cena
15	1582290	1/2"	PN 10 / 90°C	24/3	P-1	0,116	1582290	27,10 zł

31. ONYX

Kurek kulowy z korkiem, zaworkiem spustowym i dławikiem z dźwignią stalową

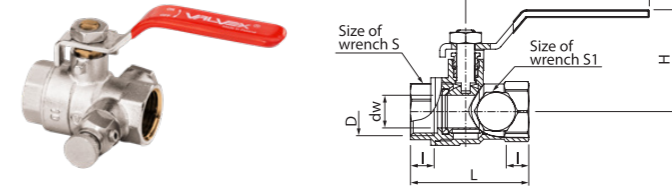

DN	Kod	Wymiary										P nom. / max temp.	Ilość szt	Opakow.	Waga netto	Kod	Cena
		Wymiar	D	I	dw	L	a	H	S	S1							
15	1452650	1/2"	G1/2	10,5	15	53	81,5	45	25	17	PN 25 / 95°C	6	P-1	0,234	1452650	41,70 zł	
20	1453650	3/4"	G3/4	11,5	19	60	104	48	31	17	PN 25 / 95°C	4	P-1	0,320	1453650	54,80 zł	
25	1454650	1"	G1	12	25	70	104	57	38	17	PN 25 / 95°C	4	P-1	0,467	1454650	74,70 zł	
32	1455650	1" 1/4"	G1 1/4	13	31	80	120	67,5	47	17	PN 16 / 95°C	4	P-1	0,650	1455650	113,10 zł	
40	1456650	1" 1/2"	G1 1/2	14	40	91	120	73	54	17	PN 16 / 95°C	2	P-1	0,932	1456650	158,20 zł	
50	1457650	2"	G2	16	50	107	142	87,5	66	17	PN 16 / 95°C	3	P-1	1,463	1457650	247,70 zł	

32. OPTI

Kurek kulowy śrutowany z filtrem skośnym i dławikiem

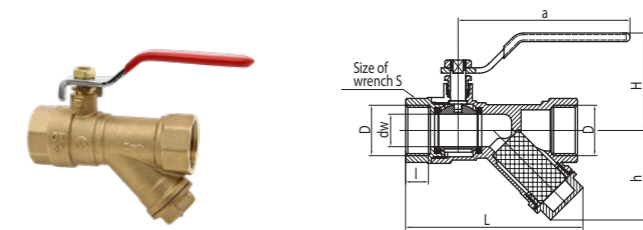

DN	Kod	Wymiary										P nom. / max temp.	Ilość szt	Opakow.	Waga netto	Kod	Cena
		Wymiar	D	I	dw	L	a	H	h	S							
15	1470020	1/2"	G1/2	13	15	84	90	50,5	38	25	PN 25 / 95°C	72/36/6	P-1	0,258	1470020	36,20 zł	
20	1470030	3/4"	G3/4	13	17	93	90	52	47	30	PN 25 / 95°C	48/24/4	P-1	0,369	1470030	52,20 zł	
25	1470040	1"	G1	14,5	22	105	105	61,5	50	38	PN 25 / 95°C	48/24/4	P-1	0,633	1470040	70,50 zł	

33. MINI

Kurek kulowy chromowany, wersja nakrętno-wkrętna

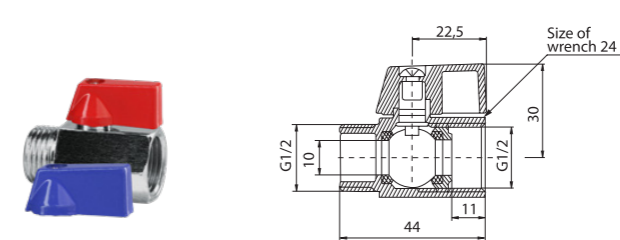

DN	Kod	Wymiar	P nom. / max temp.	Ilość szt	Opakow.	Waga netto	Kod	Cena
15	1470010	1/2"	PN 10 / 90°C	250/25	P-1 / foil bag 22x25	0,099	1470010	19,20 zł

34. MINI

Kurek kulowy chromowany, wersja nakrętno-nakrętna

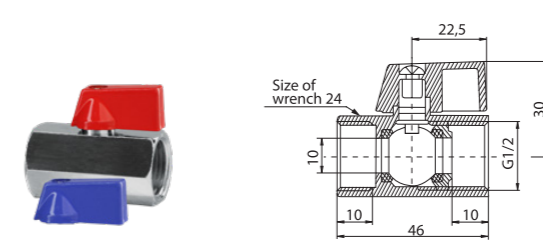

DN	Kod	Wymiar	P nom. / max temp.	Ilość szt	Opakow.	Waga netto	Kod	Cena
15	1470000	1/2"	PN 10 / 90°C	250/25	P-1 / foil bag 22x25	0,115	1470000	20,90 zł

35. PURE

Zawór antyskażeniowy mosiężny typ EA

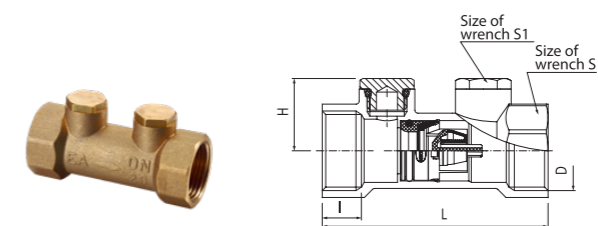

DN	Kod	Wymiary										P nom. / max temp.	Ilość szt	Opakow.	Waga netto	Kod	Cena
		Wymiar	D	I	L	H	S	S1									
15	1901000	1/2"	G1/2	11	65	21,5	26	16	PN 10 / 65°C	32	P-43	0,147	1901000	33,20 zł			
20	1901050	3/4"	G3/4	13	75	24	31	16	PN 10 / 65°C	30	P-43	0,177	1901050	38,60 zł			
25	1901100	1"	G1	14	90	27	38	16	PN 10 / 65°C	12	P-43	0,275	1901100	55,10 zł			
32	1901150	1" 1/4"	G1 1/4	16	100	30	48	16	PN 10 / 65°C	8	P-43	0,399	1901150	98,80 zł			

36. ERGO
Zawór grzybkowy kombinowany do podłączenia baterii, zmywarki/plarki

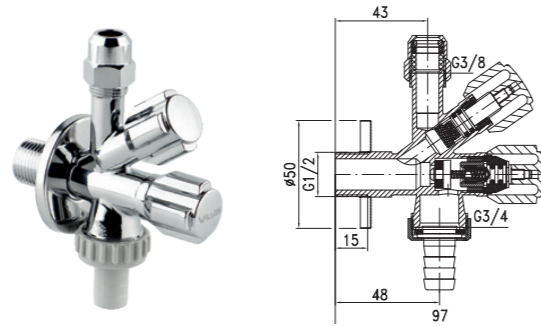

Kod	Wymiary	P nom.	Ilość szt.	Opakow.	Waga netto	Kod	Cena
1482100	1/2"-3/8"-3/4"	PN 10 / 80°C	72/1	-	0,240	1482100	62,50 zł

37. VEGA
Zawór kątowy chromowany z głowicą ceramiczną

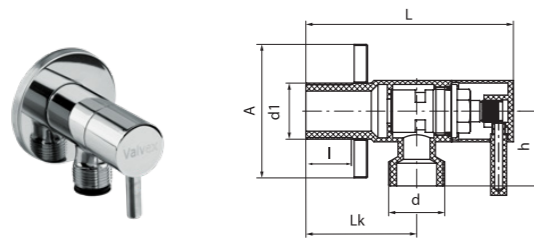

Kod	Wymiar	Wymiary							P nom.	Ilość szt.	Opakow.	Waga netto	Kod	Cena
		A	L	I	Lk	d	d1	h						
1482840	1/2"-3/8"	50	77,7	18	41,5	G3/8	G1/2	26	PN 10 / 100°C	16/1	P-21 / P-EK017A	0,141	1482840	42,50 zł
1482740	1/2"-1/2"	50	77,7	18	41,5	G1/2	G1/2	28	PN 10 / 100°C	16/1	P-21 / P-EK013A	0,143	1482740	43,40 zł
1483130	1/2"-3/4"	50	84	14	45,5	G3/4	G1/2	29	PN 10 / 100°C	16/1	P-21 / P-EK022A	0,158	1483130	46,10 zł

38. TRANGLE
Zawór kątowy chromowany z głowicą ceramiczną

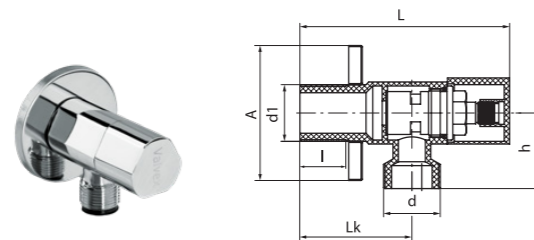

Kod	Wymiar	Wymiary							P nom. / max temp.	Ilość szt.	Opakow.	Waga netto	Kod	Cena
		A	L	I	Lk	d	d1	h						
1482810	1/2"-3/8"	50	77,7	18	41,5	G3/8	G1/2	26	PN 10 / 100°C	16/1	P-21 / P-EK017A	0,161	1482810	41,00 zł
1482770	1/2"-1/2"	50	77,7	18	41,5	G1/2	G1/2	28	PN 10 / 100°C	16/1	P-21 / P-EK013A	0,172	1482770	42,80 zł
1483140	1/2"-3/4"	50	84	13	45,5	G3/4	G1/2	29	PN 10 / 100°C	16/1	P-21 / P-EK022A	0,189	1483140	45,90 zł

39. STRIT
Zawór kątowy chromowany z głowicą ceramiczną

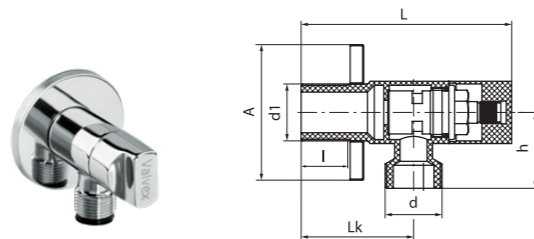

Kod	Wymiar	Wymiary							P nom. / max temp.	Ilość szt.	Opakow.	Waga netto	Kod	Cena
		A	L	I	Lk	d	d1	h						
1482870	1/2"-3/8"	50	77,7	18	41,5	G3/8	G1/2	26	PN 10 / 100°C	16/1	P-21 / P-EK019A	0,141	1482870	43,10 zł
1482750	1/2"-1/2"	50	77,7	18	41,5	G1/2	G1/2	28	PN 10 / 100°C	16/1	P-21 / P-EK014A	0,141	1482750	44,20 zł
1483120	1/2"-3/4"	50	84	14	45,5	G3/4	G1/2	29	PN 10 / 100°C	16/1	P-21 / P-EK021A	0,162	1483120	47,10 zł

40. STAR
Zawór kątowy chromowany z głowicą ceramiczną

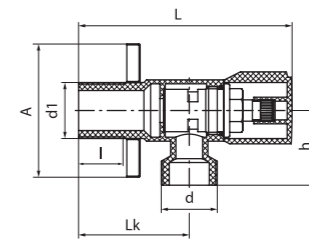

Kod	Wymiar	Wymiary							P nom. / max temp.	Ilość szt.	Opakow.	Waga netto	Kod	Cena
		A	L	I	Lk	d	d1	h						
1482860	1/2"-3/8"	50	80	18	41,5	G3/8	G1/2	26	PN 10 / 100°C	16/1	P-21 / P-EK018A	0,115	1482860	33,70 zł
1482670	1/2"-1/2"	50	80	18	41,5	G1/2	G1/2	28	PN 10 / 100°C	16/1	P-21 / P-EK012A	0,124	1482670	34,60 zł
1483110	1/2"-3/4"	50	86	13	45,5	G3/4	G1/2	29	PN 10 / 100°C	16/1	P-21 / P-EK020A	0,141	1483110	35,60 zł

41. EKO
Kurek kątowy chromowany z nakrętką (do podłączenia baterii)

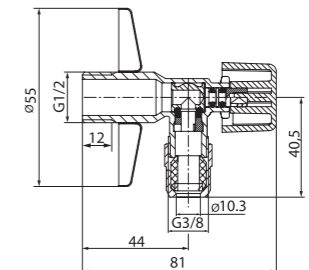

Kod	Wymiar	P nom. / max temp.	Ilość szt.	Opakow.	Waga netto	Kod	Cena
1482170	1/2"-3/8"-M10	PN 10 / 90°C	10/1	P-25 / P-EK07A	0,115	1482170	23,70 zł

42. EKO
Kurek kątowy chromowany

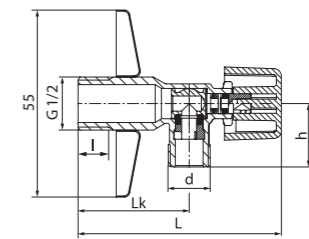

Kod	Wymiar	Wymiary					P nom. / max temp.	Ilość szt.	Opakow.	Waga netto	Kod	Cena
		L	I	Lk	d	h						
1482110	1/2"-3/8"	81	12	44	G3/8	25	PN 10 / 90°C	10/1	P-21 / P-EK01A	0,098	1482110	19,60 zł
1482120	1/2"-1/2"	81	12	44	G1/2	25	PN 10 / 90°C	10/1	P-21 / P-EK02A	0,102	1482120	20,50 zł
1482130	1/2"-3/4"	81	12	44	G3/4	28	PN 10 / 90°C	10/1	P-21 / P-EK03A	0,116	1482130	22,50 zł

43. EKO PLUS
Kurek kątowy chromowany z nakrętką (do podłączenia baterii)

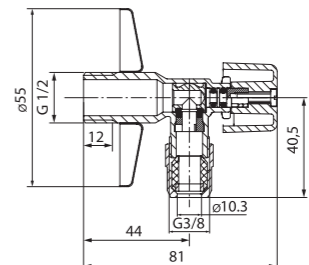

Kod	Wymiar	P nom. / max temp.	Ilość szt.	Opakow.	Waga netto	Kod	Cena
1482660	1/2"-3/8"-M10	PN 10 / 90°C	10/1	P-25 / P-EK011A	0,152	1482660	28,20 zł

44. EKO PLUS
Kurek kątowy chromowany

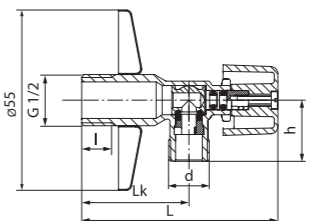

Kod	Wymiar	Wymiary					P nom. / max temp.	Ilość szt.	Opakow.	Waga netto	Kod	Cena
		L	I	Lk	d	h						
1482620	1/2"-3/8"	81	12	44	G3/8	25	PN 10 / 90°C	10/1	P-25 / P-EK08A	0,136	1482620	25,30 zł
1482630	1/2"-1/2"	81	12	44	G1/2	25	PN 10 / 90°C	10/1	P-25 / P-EK09A	0,140	1482630	27,30 zł
1482640	1/2"-3/4"	81	12	44	G3/4	28	PN 10 / 90°C	10/1	P-25 / P-EK010A	0,154	1482640	29,10 zł

45. ANGEL PLUS

Kurek kulowy kątowy chromowany z filtrem i nakrętką (do podłączenia baterii)

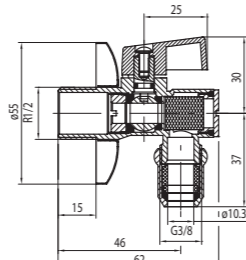

Kod	Wymiar	P nom. / max temp.	Ilość szt	Opakow.	Waga netto
1482980	1/2"-3/8"-M10	PN 10 / 90°C	10/1	P-25 / P-K8	0,127

Kod	Cena
1482980	26,10 zł

46. ANGEL PLUS

Kurek kulowy kątowy chromowany z filtrem

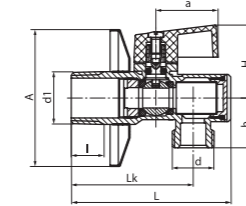

Kod	Wymiar	Wymiary										P nom. / max temp.	Ilość szt	Opakow.	Waga netto
		A	L	I	Lk	d	d1	a	H	h	h				
1481900	1/2"-3/8"	55	62	12	46	G3/8	G1/2	25	29	20	PN 10 / 90°C	10/1	P-25 / P-K7	0,111	
1481870	1/2"-1/2"	55	62	12	46	G1/2	G1/2	25	29	20	PN 10 / 90°C	10/1	P-25 / P-K6	0,116	
1481840	1/2"-3/4"	55	62	12	46	G3/4	G1/2	25	29	20	PN 10 / 90°C	10/1	P-25 / P-K5	0,119	

Kod	Cena
1481900	24,90 zł
1481870	25,40 zł
1481840	26,90 zł

47. BASE

Zawór grzybkowy kątowy chromowany z nakrętką

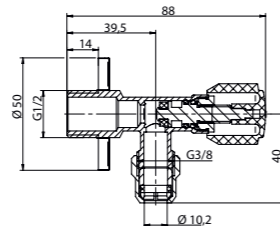

Kod	Wymiar	P nom. / max temp.	Ilość szt	Opakow.	Waga netto
1484080	1/2"-3/8"-M10	PN 10 / 90°C	10/1	P-25 / P-K9	0,128

Kod	Cena
1484080	18,80 zł

48. BASE

Zawór grzybkowy kątowy chromowany

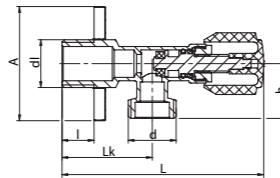

Kod	Wymiar	Wymiary										P nom. / max temp.	Ilość szt	Opakow.	Waga netto
		A	L	I	Lk	d	d1	h	h	h	h				
1484050	1/2"-3/8"	50	88	14	39,5	G3/8	G1/2	24	PN 10 / 90°C	10/1	P-25 / P-K10	0,109			
1484060	1/2"-1/2"	50	88	14	39,5	G1/2	G1/2	24	PN 10 / 90°C	10/1	P-25 / P-K11	0,116			
1484070	1/2"-3/4"	50	88	14	39,5	G3/4	G1/2	24	PN 10 / 90°C	10/1	P-25 / P-K12	0,123			

Kod	Cena
1484050	15,20 zł
1484060	16,00 zł
1484070	17,20 zł

49. PROFF

Zawór grzybkowy kątowy chromowany z nakrętką

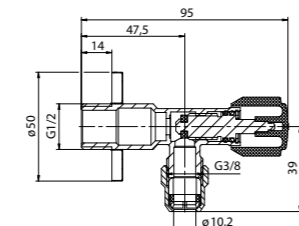

Kod	Wymiar	P nom. / max temp.	Ilość szt	Opakow.	Waga netto
1484130	1/2"-3/8"-M10	PN 10 / 100°C	10/1	P-25 / P-K9	0,128

Kod	Cena
1484130	20,80 zł

50. PROFF

Zawór grzybkowy kątowy chromowany

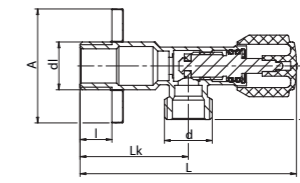

Kod	Wymiar	Wymiary							P nom. / max temp.	Ilość szt	Opakow.	Waga netto
		A	L	I	Lk	d	d1	h				
1484100	1/2"-3/8"	50	95	14	47,5	G3/8	G1/2	23,5	PN 10 / 100°C	10/1	P-25 / P-K10	0,109
1484110	1/2"-1/2"	50	95	14	47,5	G1/2	G1/2	23,5	PN 10 / 100°C	10/1	P-25 / P-K11	0,116
1484120	1/2"-3/4"	50	95	14	47,5	G3/4	G1/2	23,5	PN 10 / 100°C	10/1	P-25 / P-K12	0,123

Kod	Cena
1484100	17,60 zł
1484110	18,60 zł
1484120	19,70 zł

51. OPAL

Zawór grzybkowy kątowy chromowany z nakrętką (do podłączenia baterii)

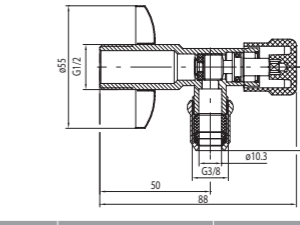

Kod	Wymiar	P nom. / max temp.	Ilość szt	Opakow.	Waga netto
1282500	1/2"-3/8"-M10	PN 10 / 100°C	10/1	P-25 / P-K9	0,128

Kod	Cena
1282500	28,40 zł

52. OPAL

Zawór grzybkowy kątowy chromowany

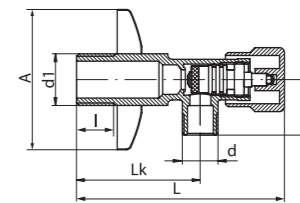

Kod	Wymiar	Wymiary							P nom. / max temp.	Ilość szt	Opakow.	Waga netto
		A	L	I	Lk	d	d1	h				
1282510	1/2"-3/8"	55	88	15	50	G3/8	G1/2	23	PN 10 / 100°C	10/1	P-25 / P-K10	0,109
1282520	1/2"-1/2"	55	88	15	50	G1/2	G1/2	23	PN 10 / 100°C	10/1	P-25 / P-K11	0,116
1282530	1/2"-3/4"	55	88	15	50	G3/4	G1/2	23	PN 10 / 100°C	10/1	P-25 / P-K12	0,123

Kod	Cena
1282510	23,20 zł
1282520	23,80 zł
1282530	24,50 zł

53. VIKING

Zawór przelotowy żeliwny (M 83)

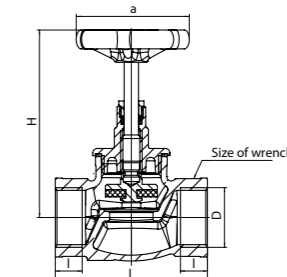

DN	Kod	Wymiary								P nom. / max temp.	Ilość szt	Opakow.	Waga netto
		Wymiar	D	L	I	H	a	S	S				
15	1292150	1/2"	G1/2	61	12	72-76	50	27	PN 10 / 100°C	10	P-1	0,325	
20	1293150	3/4"	G3/4	70	13	84-90	50	31	PN 10 / 100°C	8	P-1	0,458	
25	1294150	1"	G1	85	15	92-106	65	40	PN 10 / 100°C	5	P-1	0,725	
32	1295150	1 1/4"	G1 1/4	102	15	120-132	80	49	PN 10 / 100°C	5	P-1	1,352	
40	1296150	1 1/2"	G1 1/2	114	16	140-151	80	57	PN 10 / 100°C	4	P-1	1,852	
50	1297150	2"	G2	142	18	155-177	120	69	PN 10 / 100°C	2	P-24	3,168	

Kod	Cena
1292150	27,50 zł
1293150	34,10 zł
1294150	47,50 zł
1295150	96,40 zł
1296150	130,90 zł
1297150	209,10 zł

54. TIGER

Zawór zwrotny ze sprężyną

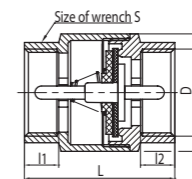

DN	Kod	Wymiary								P nom. / max temp.	Ilość szt	Opakow.	Waga netto
		Wymiar	D	A	L	I	I1	S	S				
15	1900000	1/2"	G1/2	33	45	11	11	25	PN 10 / 100°C	150/25	P-43	0,116	
20	1900010	3/4"	G3/4	38	48	13	12	31	PN 10 / 100°C	120/20	P-1	0,178	
25	1900020	1"	G1	44	57	13	13	38	PN 10 / 100°C	60/10	P-1	0,233	
32	1900030	1 1/4"	G1 1/4	59	66,5	19	15	46	PN 10 / 100°C	30/5	P-1	0,324	
40	1900040	1 1/2"	G1 1/2	68,5	68	18,5	16	52	PN 10 / 100°C	24/4	P-1	0,483	
50	1900050	2"	G2	82,5	78	19	16,5	65	PN 10 / 100°C	5	P-1	0,701	

Kod	Cena
1900000	17,50 zł
1900010	26,10 zł
1900020	33,00 zł
1900030	52,20 zł
1900040	75,80 zł
1900050	112,00 zł

55. TIGER PLUS

Zawór zwrotny ze sprężyną z metalowym trzpieniem

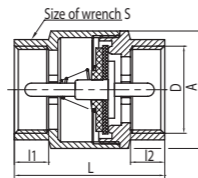

DN	Kod	Wymiary								P nom. / max temp.	Ilość szt	Opakow.	Waga netto	Kod	Cena
		Wymiar	D	A	L	I	H	S							
15	1900200	1/2"	G1/2	33	45	11	11	25	PN 10 / 120°C	150/25	P-43	0,140	1900200	20,90 zł	
20	1900210	3/4"	G3/4	38	48	13	12	31	PN 10 / 120°C	120/20	P-1	0,210	1900210	29,30 zł	
25	1900220	1"	G1	44	57	13	13	38	PN 10 / 120°C	60/10	P-1	0,259	1900220	42,50 zł	
32	1900230	1" 1/4"	G1 1/4	59	66,5	19	15	46	PN 10 / 120°C	30/5	P-1	0,420	1900230	63,60 zł	
40	1900240	1" 1/2"	G1 1/2	68,5	68	18,5	16	52	PN 10 / 120°C	24/4	P-1	0,584	1900240	92,80 zł	
50	1900250	2"	G2	82,5	78	19	16,5	65	PN 10 / 120°C	5	P-1	0,822	1900250	142,80 zł	

56. TIGER

Kosz ssawny (do zaworów zwrotnych)

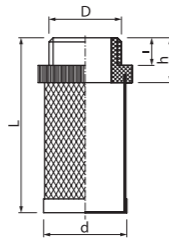

Kod	Wymiar	Wymiary						Ilość szt	Opakow.	Waga netto	Kod	Cena
		D	L	l	h	d						
1900140	1/2"	G1/2	42	8	13	24	25	P-43	0,007	1900140	4,80 zł	
1900150	3/4"	G3/4	44	7	12	30	20	P-43	0,009	1900150	6,50 zł	
1900160	1"	G1	56	10	15	36	20	P-43	0,016	1900160	8,70 zł	
1900170	1 1/4"	G1 1/4	62	10	15	43	15	P-43	0,018	1900170	10,50 zł	
1900180	1 1/2"	G1 1/2	70	10	16	53	10	P-43	0,027	1900180	12,50 zł	
1900190	2"	G2	82	12	18	63	10	P-1	0,037	1900190	16,00 zł	

57. CETUS

Reduktor ciśnienia śrutowany wersja nakrętno-nakrętna

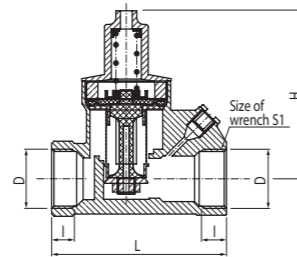

DN	Kod	Wymiary						P nom. / max temp.	Ilość szt	Opakow.	Waga netto	Kod	Cena
		Wymiar	D	L	H	S							
15	1900300	1/2"	G1/2	68	11,5	70	27	PN 16 / 75°C	18/1	P-86 / P-R1	0,431	1900300	182,90 zł
20	1900310	3/4"	G3/4	71	12	75	31,5	PN 16 / 75°C	18/1	P-86 / P-R1	0,399	1900310	187,20 zł

58. CETUS

Reduktor ciśnienia z półśrubunkiem śrutowany

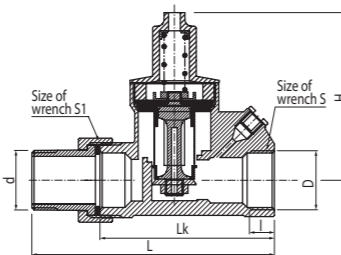

DN	Kod	Wymiary								P nom. / max temp.	Ilość szt	Opakow.	Waga netto	Kod	Cena	
		Wymiar	D	L	Lk	d	H	S	S1							
15	1900320	1/2"	G1/2	11,5	96	68	R1/2	70	27	30	PN 16 / 75°C	18/1	P-86 / P-R2	0,476	1900320	202,40 zł
20	1900330	3/4"	G3/4	12	103	71	R3/4	75	31,5	37	PN 16 / 75°C	18/1	P-86 / P-R2	0,550	1900330	219,80 zł

59. VIKING

Głowica do zaworów przelotowych żeliwnych

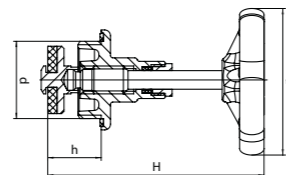
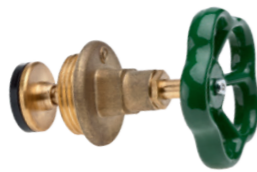

Kod	Wymiar	Wymiary					P nom. / max temp.	Ilość szt	Opakow.	Waga netto	Kod	Cena
		a	H	h	d							
1292100	1/2"	50	72	18-26	G1/2	PN 10 / 100°C	32/4	P-1	0,150	1292100	16,80 zł	
1293100	3/4"	50	82	20-29	G3/4	PN 10 / 100°C	24/3	P-1	0,202	1293100	21,10 zł	
1294100	1"	65	93	23-35	G1	PN 10 / 100°C	16/2	P-1	0,289	1294100	27,30 zł	
1295100	1 1/4"	80	114	23-45	G1 1/4	PN 10 / 100°C	10/1	P-1	0,574	1295100	56,50 zł	
1296100	1 1/2"	80	127	23-50	G1 1/2	PN 10 / 100°C	8/1	P-1	0,684	1296100	67,30 zł	
1297100	2"	120	149	25-59	G2	PN 10 / 100°C	6/1	P-1	1,354	1297100	104,60 zł	

1. VIPER PLUS - 3/8"

Wężyk do baterii z krótką końcówką

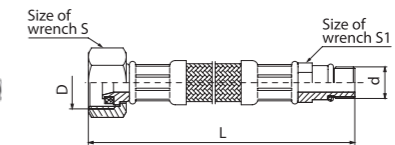

Kod	Wersja	Wymiary					P nom. / max temp.	Ilość szt.	Opakow.	Waga netto	Kod	Cena
		D	d	L	S	S1						
2902010	3/8"-M8x1-L350	G3/8	M8x1	350	19	10	PN 10 / 90°C	20/1	P-21	0,077	2902010	10,70 zł
2902030	3/8"-M8x1-L600	G3/8	M8x1	600	19	10	PN 10 / 90°C	20/1	P-29	0,114	2902030	11,70 zł
2902040	3/8"-M10x1-L350	G3/8	M10x1	350	19	10	PN 10 / 90°C	20/1	P-21	0,078	2902040	13,40 zł
2902050	3/8"-M10x1-L450	G3/8	M10x1	450	19	10	PN 10 / 90°C	20/1	P-28	0,092	2902050	15,30 zł
2902120	3/8"-M10x1-L500	G3/8	M10x1	500	19	10	PN 10 / 90°C	20/1	P-28	0,102	2902120	15,50 zł
2902060	3/8"-M10x1-L600	G3/8	M10x1	600	19	10	PN 10 / 90°C	20/1	P-29	0,117	2902060	16,80 zł

2. VIPER PLUS - 1/2"

Wężyk do baterii z krótką końcówką

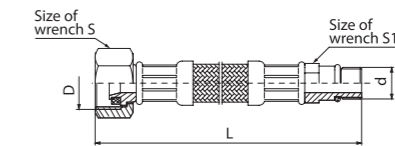

Kod	Wersja	Wymiary					P nom. / max temp.	Ilość szt.	Opakow.	Waga netto	Kod	Cena
		D	d	L	S	S1						
2902160	1/2"-M8x1-L350	G1/2	M8x1	350	23	10	PN 10 / 90°C	20/1	P-21	0,083	2902160	9,60 zł
2902170	1/2"-M8x1-L450	G1/2	M8x1	450	23	10	PN 10 / 90°C	20/1	P-28	0,096	2902170	10,30 zł
2902070	1/2"-M8x1-L500	G1/2	M8x1	500	23	10	PN 10 / 90°C	20/1	P-28	0,111	2902070	11,80 zł
2902080	1/2"-M8x1-L600	G1/2	M8x1	600	23	10	PN 10 / 90°C	20/1	P-29	0,127	2902080	14,60 zł
2902140	1/2"-M10x1-L350	G1/2	M10x1	350	23	10	PN 10 / 90°C	20/1	P-21	0,085	2902140	13,20 zł
2902150	1/2"-M10x1-L450	G1/2	M10x1	450	23	10	PN 10 / 90°C	20/1	P-28	0,097	2902150	14,80 zł
2902090	1/2"-M10x1-L500	G1/2	M10x1	500	23	10	PN 10 / 90°C	20/1	P-28	0,105	2902090	15,90 zł
2902100	1/2"-M10x1-L600	G1/2	M10x1	600	23	10	PN 10 / 90°C	20/1	P-29	0,119	2902100	19,40 zł

3. VIPER PLUS - 3/8"-3/8"

Wężyk z gwintem wewnętrznym

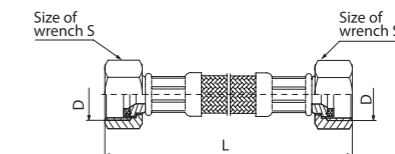

Kod	Wersja	Wymiary			P nom. / max temp.	Ilość szt.	Opakow.	Waga netto	Kod	Cena
		D	L	S						
2902310	3/8"-L200	G3/8	200	19	PN 10 / 90°C	20/1	P-22	0,066	2902310	11,20 zł
2902320	3/8"-L300	G3/8	300	19	PN 10 / 90°C	20/1	P-21	0,083	2902320	12,40 zł
2902330	3/8"-L400	G3/8	400	19	PN 10 / 90°C	20/1	P-28	0,097	2902330	13,20 zł
2902340	3/8"-L500	G3/8	500	19	PN 10 / 90°C	20/1	P-28	0,103	2902340	14,20 zł

4. VIPER PLUS - 1/2"-1/2"

Wężyk z gwintem wewnętrznym

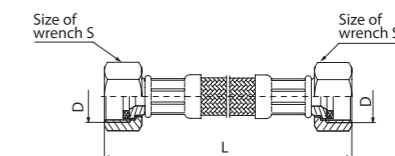

Kod	Wersja	Wymiary			P nom. / max temp.	Ilość szt.	Opakow.	Waga netto	Kod	Cena
		D	L	S						
2902350	1/2"-L200	G1/2	200	23	PN 10 / 90°C	20/1	P-22	0,078	2902350	13,00 zł
2902360	1/2"-L300	G1/2	300	23	PN 10 / 90°C	20/1	P-21	0,091	2902360	13,70 zł
2902370	1/2"-L400	G1/2	400	23	PN 10 / 90°C	20/1	P-28	0,111	2902370	14,80 zł
2902380	1/2"-L500	G1/2	500	23	PN 10 / 90°C	20/1	P-28	0,120	2902380	16,00 zł
2902390	1/2"-L600	G1/2	600	23	PN 10 / 90°C	20/1	P-29	0,137	2902390	17,20 zł
2902750	1/2"-L700	G1/2	700	23	PN 10 / 90°C	20/1	P-30	0,151	2902750	18,00 zł
2902760	1/2"-L800	G1/2	800	23	PN 10 / 90°C	20/1	P-30	0,167	2902760	18,80 zł
2902400	1/2"-L1000	G1/2	1000	23	PN 10 / 90°C	20/1	P-31	0,176	2902400	22,00 zł
2902770	1/2"-L1200	G1/2	1200	23	PN 10 / 90°C	20/1	P-16	0,229	2902770	22,40 zł
2902780	1/2"-L1500	G1/2	1500	23	PN 10 / 90°C	20/1	P-26	0,273	2902780	23,50 zł
2902790	1/2"-L2000	G1/2	2000	23	PN 10 / 90°C	20/1	P-24	0,346	2902790	30,40 zł

5. VIPER PLUS - 3/4"-3/4"

Wężyk z gwintem wewnętrznym

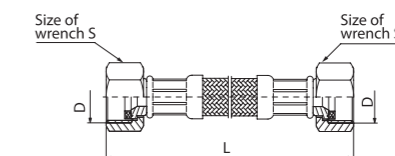

Kod	Wersja	Wymiary			P nom. / max temp.	Ilość szt.	Opakow.	Waga netto	Kod	Cena
		D	L	S						
2902800	3/4"-L300	G3/4	300	29	PN 10 / 90°C	20/1	P-28	0,144	2902800	20,30 zł
2902810	3/4"-L400	G3/4	400	29	PN 10 / 90°C	20/1	P-28	0,159	2902810	21,60 zł
2902410	3/4"-L500	G3/4	500	29	PN 10 / 90°C	20/1	P-30	0,174	2902410	27,50 zł
2902420	3/4"-L600	G3/4	600	29	PN 10 / 90°C	20/1	P-30	0,189	2902420	28,80 zł
2902430	3/4"-L800	G3/4	800	29	PN 10 / 90°C	20/1	P-9	0,222	2902430	35,00 zł

6. VIPER PLUS - 1/2"-3/8"

Wężyk redukcyjny z gwintem wewnętrznym

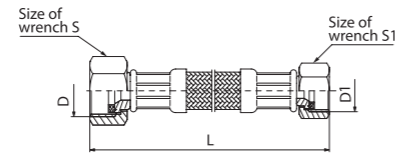

Kod	Wersja	Wymiary					P nom. / max temp.	Ilość szt.	Opakow.	Waga netto	Kod	Cena
		D	D1	L	S	S1						
2902510	1/2"-3/8"-L200	G1/2	G3/8	200	23	19	PN 10 / 90°C	20/1	P-22	0,070	2902510	11,70 zł
2902520	1/2"-3/8"-L300	G1/2	G3/8	300	23	19	PN 10 / 90°C	20/1	P-21	0,080	2902520	13,00 zł
2902530	1/2"-3/8"-L400	G1/2	G3/8	400	23	19	PN 10 / 90°C	20/1	P-28	0,101	2902530	14,00 zł
2902540	1/2"-3/8"-L500	G1/2	G3/8	500	23	19	PN 10 / 90°C	20/1	P-28	0,114	2902540	15,50 zł
2902500	1/2"-3/8"-L600	G1/2	G3/8	600	23	19	PN 10 / 90°C	20/1	P-29	0,130	2902500	16,30 zł
2902490	1/2"-3/8"-L800	G1/2	G3/8	800	23	19	PN 10 / 90°C	20/1	P-30	0,152	2902490	16,90 zł

7. VIPER PLUS - 3/4"-1/2"

Wężyk redukcyjny z gwintem wewnętrznym

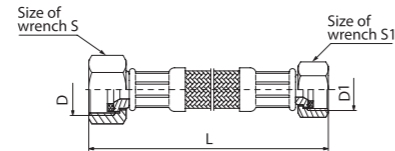

Kod	Wersja	Wymiary					P nom. / max temp.	Ilość szt.	Opakow.	Waga netto	Kod	Cena
		D	D1	L	S	S1						
2902550	3/4"-1/2"-L300	G3/4	G1/2	300	29	23	PN 10 / 90°C	20/1	P-28	0,117	2902550	19,80 zł
2902560	3/4"-1/2"-L400	G3/4	G1/2	400	29	23	PN 10 / 90°C	20/1	P-28	0,133	2902560	21,10 zł
2902570	3/4"-1/2"-L500	G3/4	G1/2	500	29	23	PN 10 / 90°C	20/1	P-29	0,145	2902570	22,10 zł

8. VIPER PLUS - 1/2"-1/2"

Wężyk z gwintem wewnętrznym - zewnętrznym

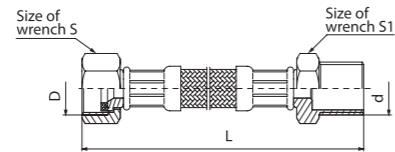

Kod	Wersja	Wymiary					P nom. / max temp.	Ilość szt.	Opakow.	Waga netto	Kod	Cena
		D	d	L	S	S1						
2902610	1/2"-1/2"-L300	G1/2	G1/2	300	23	21	PN 10 / 90°C	20/1	P-21	0,100	2902610	14,80 zł
2902620	1/2"-1/2"-L400	G1/2	G1/2	400	23	21	PN 10 / 90°C	20/1	P-28	0,116	2902620	14,90 zł
2902630	1/2"-1/2"-L500	G1/2	G1/2	500	23	21	PN 10 / 90°C	20/1	P-28	0,119	2902630	16,30 zł
2902640	1/2"-1/2"-L600	G1/2	G1/2	600	23	21	PN 10 / 90°C	20/1	P-29	0,146	2902640	18,00 zł
2902580	1/2"-1/2"-L700	G1/2	G1/2	700	23	21	PN 10 / 90°C	20/1	P-30	0,156	2902580	18,60 zł
2902590	1/2"-1/2"-L800	G1/2	G1/2	800	23	21	PN 10 / 90°C	20/1	P-30	0,171	2902590	19,40 zł
2902650	1/2"-1/2"-L1000	G1/2	G1/2	1000	23	21	PN 10 / 90°C	20/1	P-31	0,203	2902650	22,10 zł

1. 4TECH

Kurek kulowy pełnoprzelotowy do gazu z dźwignią stalową, wersja nakrętno-nakrętna

CE 1299

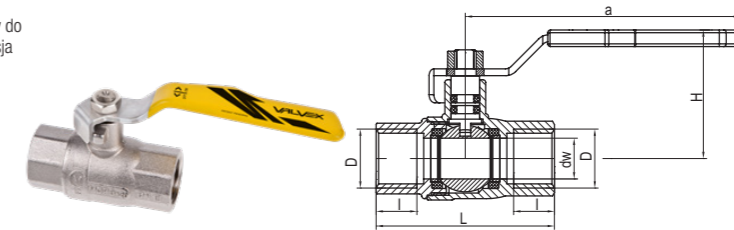

DN	Kod	Wymiar	Wymiary							P nom. / max temp.	Ilość szt.	Opakow.	Waga netto	Kod	Cena
			D	I	dw	L	a	H	S						
15	3402600	1/2"	Rp1/2	15	15	65,6	101,2	47,3	26	MOP 5-20 / T3	15	P-1	0,204	3402600	39,30 zł
20	3403600	3/4"	Rp3/4	16,3	20	72,6	101,2	51,3	31	MOP 5-20 / T3	10	P-1	0,314	3403600	56,80 zł
25	3404600	1"	Rp1	19,1	25	87	121,2	60,8	39	MOP 5-20 / T3	5	P-1	0,523	3404600	85,80 zł

2. ORION

Kurek kulowy pełnoprzelotowy do gazu z dźwignią stalową, wersja nakrętno-nakrętna

CE 1299

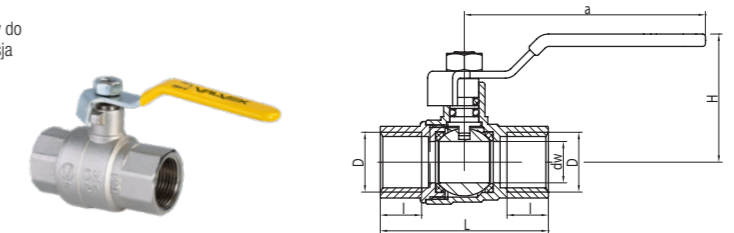

DN	Kod	Wymiar	Wymiary							P nom. / max temp.	Ilość szt.	Opakow.	Waga netto	Kod	Cena
			D	I	dw	L	a	H	S						
15	3412050	1/2"	Rp1/2	15	15	61	86,5	46,5		MOP 5-20 / T3	10	P-1	0,204	3412050	31,70 zł
20	3413050	3/4"	Rp3/4	16,3	20	69	86,5	55,5		MOP 5-20 / T3	6	P-1	0,314	3413050	46,40 zł
25	3414050	1"	Rp1	19,1	25	82	100	60		MOP 5-20 / T3	6	P-1	0,523	3414050	67,70 zł
32	3415030	1" 1/4"	Rp1 1/4	21,4	32	95	150	75		MOP 5-20 / T3	2	P-1	0,874	3415030	116,10 zł
40	3406030	1" 1/2"	Rp1 1/2	21,4	40	105	150	81		MOP 5-20 / T3	4	P-1	1,203	3406030	160,90 zł
50	3407030	2"	Rp2	25,7	50	127	150	91		MOP 5-20 / T3	2	P-1	1,993	3407030	249,80 zł

3. ORION

Kurek kulowy pełnoprzelotowy do gazu z motykiem aluminiowym (MAI), wersja nakrętno-nakrętna

CE 1299

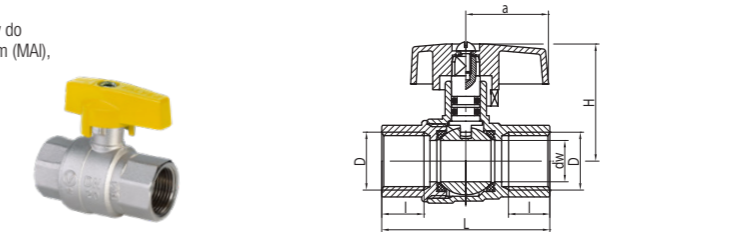

DN	Kod	Wymiar	Wymiary							P nom. / max temp.	Ilość szt.	Opakow.	Waga netto	Kod	Cena
			D	I	dw	L	a	H	S						
15	3412070	1/2"	Rp1/2	15	15	61	30	43		MOP 5-20 / T3	10	P-1	0,197	3412070	31,70 zł
20	3413070	3/4"	Rp3/4	16,3	20	69	30	47		MOP 5-20 / T3	6	P-1	0,300	3413070	46,40 zł
25	3414070	1"	Rp1	19,1	25	82	40	57		MOP 5-20 / T3	6	P-1	0,512	3414070	67,70 zł

4. ORION

Kurek kulowy pełnoprzelotowy do gazu z dźwignią stalową, wersja nakrętno-wkrętna

CE 1299

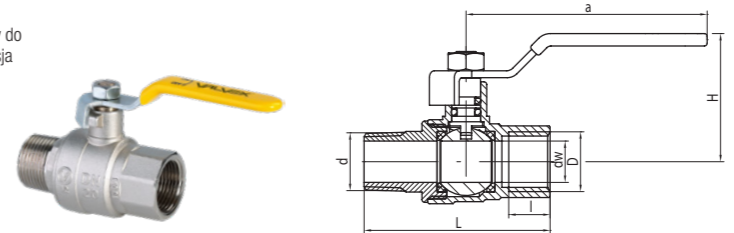

DN	Kod	Wymiar	Wymiary							P nom. / max temp.	Ilość szt.	Opakow.	Waga netto	Kod	Cena
			D	I	dw	L	a	H	d						
15	3412090	1/2"	Rp1/2	15	15	67,5	86,5	46,5	R1/2	MOP 5-20 / T3	10	P-1	0,205	3412090	35,00 zł
20	3413090	3/4"	Rp3/4	16,3	20	75,5	86,5	50,5	R3/4	MOP 5-20 / T3	6	P-1	0,319	3413090	51,90 zł
25	3414090	1"	Rp1	19,1	25	87,5	103	60	R1	MOP 5-20 / T3	6	P-1	0,526	3414090	72,20 zł

5. ORION

Kurek kulowy pełnoprzelotowy do gazu z motykiem aluminiowym (MAI), wersja nakrętno-wkrętna

CE 1299

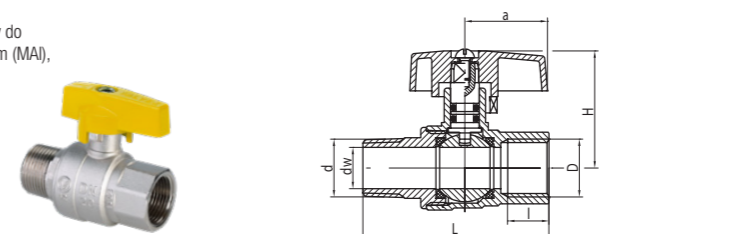

DN	Kod	Wymiar	Wymiary							P nom. / max temp.	Ilość szt.	Opakow.	Waga netto	Kod	Cena
			D	I	dw	L	a	H	d						
15	3412150	1/2"	Rp1/2	15	15	67,5	30	43	R1/2	MOP 5-20, T3	10	P-1	0,198	3412150	35,00 zł
20	3413150	3/4"	Rp3/4	16,3	20	75,5	30	47	R3/4	MOP 5-20, T3	6	P-1	0,309	3413150	51,90 zł
25	3414150	1"	Rp1	19,1	25	87,5	40	57	R1	MOP 5-20, T3	6	P-1	0,507	3414150	72,20 zł





6. ORION
Kurek kulowy z obrotową nakrętką

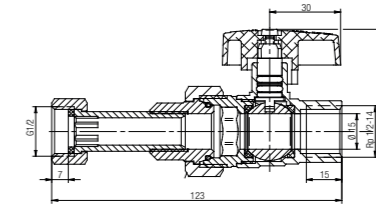

DN	Kod	Rozmiar	P nom. / max temp.	Ilość szt.	Opakow.	Waga netto	Kod	Cena
15	3402100	1/2"	MOP 5 / -20° – +60°C	5	P-1472.60/1	0.422	3402100	99,00 zł

7. V-GAS
Filtr do gazu śrutowany

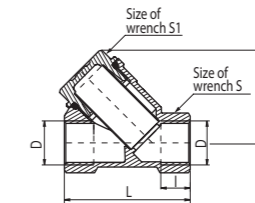

DN	Kod	Wymiary							P nom. / max temp.	Ilość szt.	Opakow.	Waga netto	Kod	Cena
		Wymiar	D	L	I	H	S	S1						
15	3900100	1/2"	Rp1/2	64	15	44	26	26	MOP 5, T4	12	P-1	0,214	3900100	32,30 zł
20	3900200	3/4"	Rp3/4	77	16,3	51,5	32	27	MOP 5, T4	8	P-1	0,371	3900200	47,40 zł
25	3900300	1"	Rp1	92,5	19,1	59,5	41	30	MOP 5, T4	5	P-1	0,593	3900300	75,90 zł

8. V-GAS
Przewód elastyczny do gazu w osłonie PCV z obrotową nakrętką

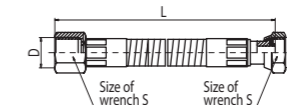

Kod	Dimension					P nom.	Ilość szt.	Opakow.	Waga netto	Kod	Cena
	Wymiar	D	D1	L	S						
3901500	L=500	Rp1/2	G1/2	500	24	MOP 0,5	10/1	P-33	0,270	3901500	76,30 zł
3901510	L=750	Rp1/2	G1/2	750	24	MOP 0,5	10/1	P-33	0,361	3901510	84,50 zł
3901520	L=1000	Rp1/2	G1/2	1000	24	MOP 0,5	5/1	P-33	0,450	3901520	92,60 zł
3901530	L=1250	Rp1/2	G1/2	1250	24	MOP 0,5	5/1	P-33	0,544	3901530	101,80 zł
3901540	L=1500	Rp1/2	G1/2	1500	24	MOP 0,5	5/1	P-33	0,640	3901540	113,70 zł
3901700	L=2000	Rp1/2	G1/2	2000	24	MOP 0,5	3/1	P-33	0,850	3901700	127,80 zł

9. V-GAS
Przewód elastyczny do gazu V-GAS w osłonie PCV 1/2" ze złączką kolankową z obrotowymi nakrętkami

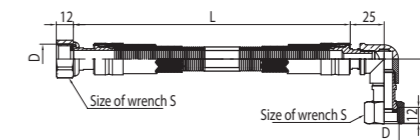

Kod	Dimension				P nom.	Ilość szt.	Opakow.	Waga netto	Kod	Cena
	Wymiar	D	L	S						
3901750	L=500	G1/2	500	24	MOP 0,5	10/1	P-33	0,320	3901750	93,20 zł
3901760	L=750	G1/2	750	24	MOP 0,5	10/1	P-33	0,390	3901760	104,60 zł
3901770	L=1000	G1/2	1000	24	MOP 0,5	5/1	P-33	0,470	3901770	114,70 zł
3901780	L=1250	G1/2	1250	24	MOP 0,5	5/1	P-33	0,530	3901780	126,10 zł
3901790	L=1500	G1/2	1500	24	MOP 0,5	5/1	P-33	0,610	3901790	136,40 zł
3901800	L=2000	G1/2	2000	24	MOP 0,5	3/1	P-33	0,740	3901800	153,20 zł



1. THERMO

Głowica termostatyczna typ GZ.08A

GUARANTEE
5
YEARS

GŁOWICA	GZ08A
zawór VECTOR	
zawór IRIS	X
przyłącze M30x1,5 (typ Heimeier)	X
Danfoss z przyłączem RA - w przypadku grzejników z wkładką typu DANFOSS należy zastosować adapter - 4445110	

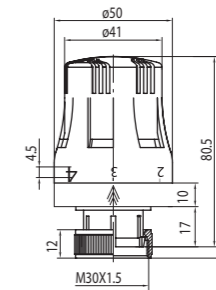

Kod	Wersja	Ilość szt.	Opakow.	Waga netto	Kod	Cena
4445050	7÷28°C	30/1	P-42	0,123	4445050	35,30 zł

2. FUSION

Głowica termostatyczna typ GZ.05A

GUARANTEE
5
YEARS

GŁOWICA	GZ05A
zawór VECTOR	
zawór IRIS	X
przyłącze M30x1,5 (typ Heimeier)	X
Danfoss z przyłączem RA - w przypadku grzejników z wkładką typu DANFOSS należy zastosować adapter - 4445110	

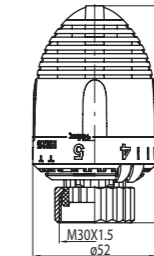

Kod	Wersja	Ilość szt.	Opakow.	Waga netto	Kod	Cena
4440010	GZ.05A 6÷28°C	30/1	P-42 / P-11c	0,130	4440010	43,20 zł

3. VECTOR

Głowica termostatyczna typ GZ.05

GUARANTEE
5
YEARS

GŁOWICA	GZ05
zawór VECTOR	X
zawór IRIS	
przyłącze M30x1,5 (typ Heimeier)	
Danfoss z przyłączem RA - w przypadku grzejników z wkładką typu DANFOSS należy zastosować adapter - 4445110	

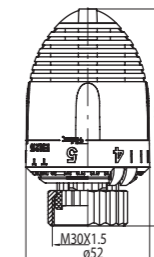

Kod	Wersja	Ilość szt.	Opakow.	Waga netto	Kod	Cena
4440000	GZ.05 6÷28°C	30/1	P-42 / P-11b	0,137	4440000	43,20 zł

4. VIRGO

Głowica termostatyczna typ GZ.03

GUARANTEE
5
YEARS

GŁOWICA	GZ03
zawór VECTOR	X
zawór IRIS	
przyłącze M30x1,5 (typ Heimeier)	
Danfoss z przyłączem RA - w przypadku grzejników z wkładką typu DANFOSS należy zastosować adapter - 4445110	

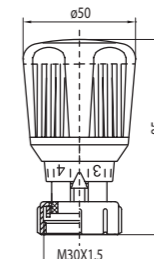

Kod	Wersja	Ilość szt.	Opakow.	Waga netto	Kod	Cena
4410000	GZ.03 6÷30°C	30/1	P-42 / P-11	0,131	4410000	42,10 zł

5. IRIS

Zawór termostatyczny prosty, niklowany

GUARANTEE
25
YEARS

GŁOWICA	IRIS
GZ.08A	X
GZ.05A	X
GZ.03A	X
GZ.05	
GZ.03	

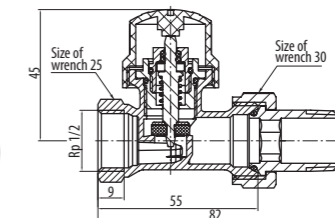

Kod	Kolor	Wymiar	P nom.	Ilość szt.	Opakow.	Waga netto	Kod	Cena
4445510	NIKLOWANY	1/2"	PN 10	100/25/1	P-136/P-12a	0,235	4445510	46,50 zł
4445530	BIAŁY	1/2"	PN 10	100/25/1	P-136/P-12a	0,235	4445530	60,10 zł

6. IRIS
Zawór termostatyczny kątowy, nikielowy



GŁOWICA	IRIS
GZ.08A	X
GZ.05A	X
GZ.03A	X
GZ.05	
GZ.03	

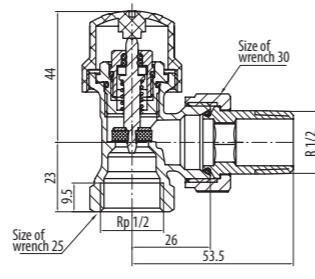

Kod	Kolor	Wymiar	P nom.	Ilość szt.	Opakow.	Waga netto	Kod	Cena
4445610	NIKLOWANY	1/2"	PN 10	100/25/1	P-136/P-12a	0,235	4445610	46,50 zł
4445630	BIAŁY	1/2"	PN 10	100/25/1	P-136/P-12a	0,235	4445630	60,10 zł

7. VECTOR
Zawór termostatyczny prosty ZT22 nikielowy z ruchomą przysłoną (z nastawą wstępną)

GŁOWICA	VECTOR
GZ.08A	
GZ.05A	
GZ.03A	
GZ.05	X
GZ.03	X

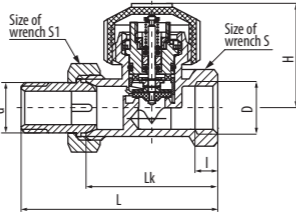

DN	Kod	Kolor	Wymiar	D	d	L	Lk	I	H	S	S1	P nom.	Ilość szt.	Opakow.	Waga netto	Kod	Cena
FP 10	4411010	NIKLOWANY	3/8"	Rp3/8	R3/8	75	50	9	41,5	22	27	PN 10	30/1	P-25 / P-12	0,228	4411010	53,30 zł
FP 15	4412010	NIKLOWANY	1/2"	Rp1/2	R1/2	82	55	10	41,5	27	30	PN 10	30/1	P-25 / P-12	0,271	4412010	56,50 zł
FP 20	4413010	NIKLOWANY	3/4"	Rp3/4	R3/4	98	65	12	43	32	37	PN 10	30/1	P-25 / P-12	0,352	4413010	67,90 zł
FP 15	4412090	BIAŁY	1/2"	Rp1/2	R1/2	82	55	10	41,5	27	30	PN 10	30/1	P-25 / P-12	0,271	4412090	73,70 zł

8. VECTOR
Zawór termostatyczny kątowy ZT22 nikielowy z ruchomą przysłoną (z nastawą wstępną)

GŁOWICA	VECTOR
GZ.08A	
GZ.05A	
GZ.03A	
GZ.05	X
GZ.03	X

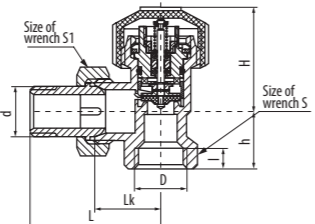

DN	Kod	Kolor	Wymiar	D	d	L	Lk	I	H	h	S	S1	P nom.	Ilość szt.	Opakow.	Waga netto	Kod	Cena
FK 15	4512010	NIKLOWANY	1/2"	Rp1/2	R1/2	53	26	10	41,5	23	27	30	PN 10	30/1	P-25 / P-12	0,253	4512010	56,50 zł
FK 20	4513010	NIKLOWANY	3/4"	Rp3/4	R3/4	63	30	12	43	26	32	37	PN 10	30/1	P-25 / P-12	0,326	4513010	67,90 zł
FK 15	4512090	BIAŁY	1/2"	Rp1/2	R1/2	53	26	10	41,5	23	27	30	PN 10	30/1	P-25 / P-12	0,253	4512090	73,70 zł

9. VECTOR
Zawór grzejnikowy odcinający prosty ZO-P-15 nikielowy

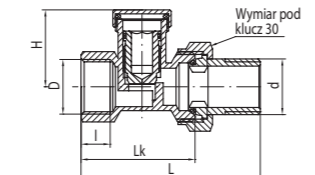

DN	Kod	Kolor	Wymiar	D	d	L	Lk	I	H	S	P nom.	Ilość szt.	Opakow.	Waga netto	Kod	Cena
10	4420020	NICKEL	3/8"	Rp3/8	R3/8	64,5	43	10	29	24	PN 10	80/10	P-43	0,128	4420020	19,80 zł
15	4420080	NICKEL	1/2"	Rp1/2	R1/2	67,5	43	11	29	30	PN 10	80/10	P-43	0,160	4420080	23,30 zł
15	4420300	WHITE	1/2"	Rp1/2	R1/2	67,5	43	11	29	30	PN 10	80/10	P-43	0,160	4420300	30,00 zł

10. VECTOR
Zawór grzejnikowy odcinający kątowy ZO-K-15 nikielowy

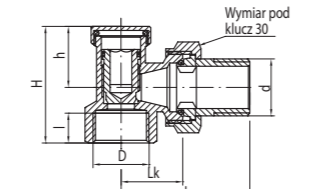

DN	Kod	Kolor	Wymiar	D	d	L	Lk	I	H	S	P nom.	Ilość szt.	Opakow.	Waga netto	Kod	Cena	
10	4520020	NICKEL	3/8"	Rp3/8	R3/8	64,5	43	10	40,5	24	22,5	PN 10	80/10	P-43	0,128	4520020	19,80 zł
15	4520080	NICKEL	1/2"	Rp1/2	R1/2	67,5	48	11	43	30	22,5	PN 10	80/10	P-43	0,150	4520080	23,30 zł
15	4520300	WHITE	1/2"	Rp1/2	R1/2	67,5	48	11	43	30	22,5	PN 10	80/10	P-43	0,150	4520300	30,00 zł

11. THERMO SET
Zestaw termostatyczny prosty, nikielowy



Rys. techn.:
• poz. 1
• poz. 5
• poz. 9

Kod	Wymiar	P nom.	Ilość szt.	Opakow.	Waga netto	Kod	Cena
4445200	1/2"	PN 10	20/1	P-4445.20/2 / P-4445.20/1	0,513	4445200	92,50 zł

12. THERMO SET
Zestaw termostatyczny kątowy, nikielowy



Rys. techn.:
• poz. 1
• poz. 6
• poz. 10

Kod	Wymiar	P nom.	Ilość szt.	Opakow.	Waga netto	Kod	Cena
4445250	1/2"	PN 10	20/1	P-4445.20/2 / P-4445.25/1	0,492	4445250	92,50 zł

13. VECTOR MAX
Zestaw termostatyczny prosty duży, nikielowy



Rys. techn.:
• poz. 3
• poz. 7
• poz. 9

Kod	Wymiar	P nom.	Ilość szt.	Opakow.	Waga netto	Kod	Cena
4412500	1/2"	PN 10	24/1	P-87 / P-set	0,563	4412500	114,70 zł

14. VECTOR MAX
Zestaw termostatyczny kątowy duży, nikielowy



Rys. techn.:
• poz. 3
• poz. 8
• poz. 10

Kod	Wymiar	P nom.	Ilość szt.	Opakow.	Waga netto	Kod	Cena
4512500	1/2"	PN 10	24/1	P-87 / P-set	0,537	4512500	114,70 zł

15. THERMO PLUS
Zestaw termostatyczny prosty duży z 2 przyłączkami G 1/2 / 3/4, nikielowy



Rys. techn.:
• poz. 1
• poz. 23

Kod	Wymiar	P nom. / T max	Ilość szt.	Opakow.	Waga netto	Kod	Cena
4445100	GZ3/4-GW3/4	PN 10 / 100°C	24/1	P-87	0,513	4445100	95,90 zł

16. THERMO PLUS

Zestaw termostatyczny kątowny duży z 2 przyłączkami G 1/2 / 3/4, niklowany



Rys. techn.:
• poz. 1
• poz. 24



Kod	Wymiar	P nom. / T max	Ilość szt.	Opakow.	Waga netto	Kod	Cena
4445150	GZ3/4-GW3/4	PN 10 / 100°C	24/1	P-87	0,492	4445150	95,90 zł

17. THERMO SET

Zestaw termostatyczny prosty, niklowany



Rys. techn.:
• poz. 1
• poz. 25



Kod	Wymiar	P nom. / T max	Ilość szt.	Opakow.	Waga netto	Kod	Cena
4445300	GZ3/4-GW3/4	PN 10 / 100°C	20/1	P-4445.20/2 / P-4445.30/1	0,482	4445300	83,30 zł

18. THERMO SET

Zestaw termostatyczny kątowny, niklowany



Rys. techn.:
• poz. 1
• poz. 26



Kod	Wymiar	P nom. / T max	Ilość szt.	Opakow.	Waga netto	Kod	Cena
4445350	GZ3/4-GW3/4	PN 10 / 100°C	20/1	P-4445.20/2 / P-4445.35/1	0,485	4445350	83,30 zł

19. FUSION

Zespół odcinający prosty do grzejników kompaktowych z 2 tulejkami pośrednimi niklowany

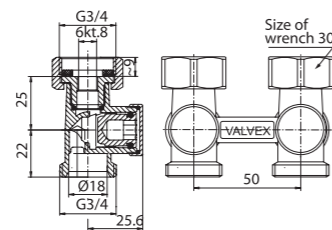

Kod	Wymiar	P nom. / T max	Ilość szt.	Opakow.	Waga netto	Kod	Cena
1480010	GZ3/4-GW3/4	PN 10 / 100°C	10	P-22	0,359	1480010	54,30 zł

20. FUSION

Zespół odcinający prosty do grzejników kompaktowych z 2 przyłączkami G 1/2 / 3/4 niklowany

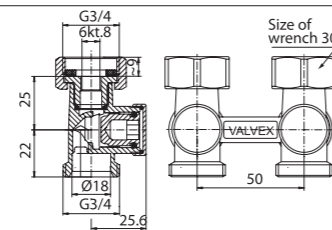

Kod	Wymiar	P nom. / T max	Ilość szt.	Opakow.	Waga netto	Kod	Cena
1480030	GZ3/4-GW3/4	PN 10 / 100°C	10	P-21	0,405	1480030	63,40 zł

21. FUSION

Zespół odcinający kątowny do grzejników kompaktowych z 2 tulejkami pośrednimi niklowany

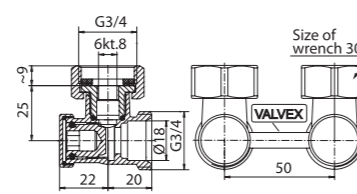

Kod	Wymiar	P nom. / T max	Ilość szt.	Opakow.	Waga netto	Kod	Cena
1480050	GZ3/4-GW3/4	PN 10 / 100°C	10	P-22	0,312	1480050	54,30 zł

22. FUSION

Zespół odcinający kątowny do grzejników kompaktowych z 2 przyłączkami G 1/2 / 3/4

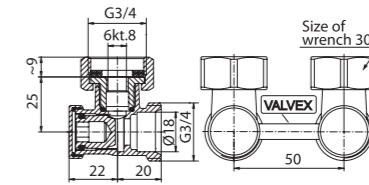

Kod	Wymiar	P nom. / T max	Ilość szt.	Opakow.	Waga netto	Kod	Cena
1480070	GZ3/4-GW3/4	PN 10 / 100°C	10	P-21	0,361	1480070	63,40 zł

23. FUSION 3

Zespół odcinający prosty do grzejników kompaktowych z 2 przyłączkami G 1/2 / 3/4 niklowany

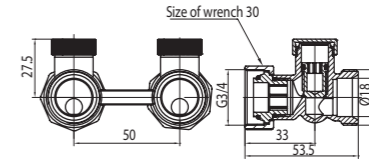

Kod	Wymiar	P nom. / T max	Ilość szt.	Opakow.	Waga netto	Kod	Cena
4412750	GZ3/4-GW3/4	PN 10 / 100°C	10/1	P-21	0,405	4412750	60,90 zł

24. FUSION 3

Zespół odcinający kątowny do grzejników kompaktowych z 2 przyłączkami G 1/2 / 3/4

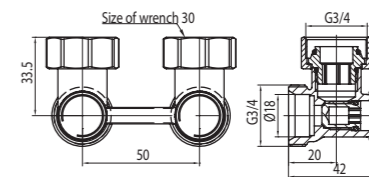

Kod	Wymiar	P nom. / T max	Ilość szt.	Opakow.	Waga netto	Kod	Cena
4512750	GZ3/4-GW3/4	PN 10 / 100°C	10/1	P-21	0,361	4512750	54,90 zł

25. FUSION 3

Zespół odcinający prosty do grzejników kompaktowych

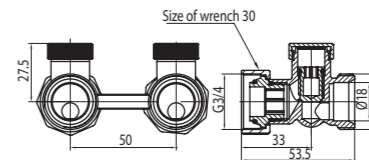

Kod	Wymiar	P nom. / T max	Ilość szt.	Opakow.	Waga netto	Kod	Cena
1480500	GZ3/4-GW3/4	PN 10 / 100°C	10	P-21	0,359	1480500	50,60 zł

26. FUSION 3

Zespół odcinający kątowny do grzejników kompaktowych

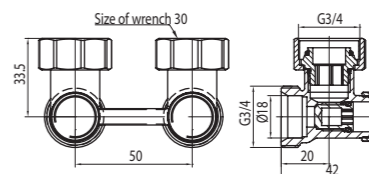

Kod	Wymiar	P nom. / T max	Ilość szt.	Opakow.	Waga netto	Kod	Cena
1480600	GZ3/4-GW3/4	PN 10 / 100°C	10	P-21	0,361	1480600	45,80 zł

27. FUSION

Tulejka

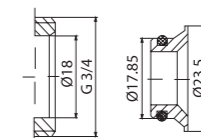

Kod	Ilość szt.	Opakow.	Waga netto	Kod	Cena
1481770	640/20	P-10 / P-14	0,010	1481770	3,90 zł

28. FUSION
Przyłączka G1/2-G3/4 nikielowana

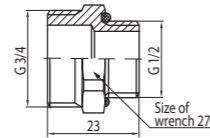

Kod	Wymiar	Ilość szt.	Opakow.	Waga netto	Kod	Cena
1481790	1/2"/3/4"	320/10	P-10 / P-14	0,051	1481790	10,00 zł

29. FUSION 3
Przyłączka G1/2-G3/4 nikielowana

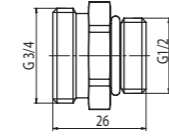

Kod	Wymiar	Ilość szt.	Opakow.	Waga netto	Kod	Cena
6097060	1/2"/3/4"	320/10	P-10 / P-14	0,051	6097060	7,50 zł

30. VECTOR LUX
Termolux TRG-2 G3/4" nikielowany

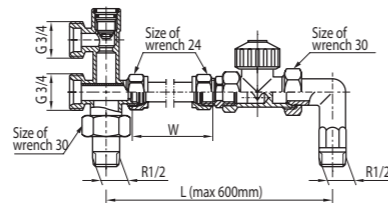

Kod	Wymiar	P nom. / T max	Ilość szt.	Opakow.	Waga netto	Kod	Cena
4400030	TRG-2 G3/4"	PN 10 / 120°C	8	P-9	0,908	4400030	277,50 zł

31. IRIS
Adapter

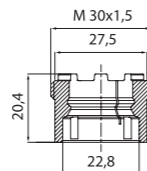

Kod	Ilość szt.	Opakow.	Waga netto	Kod	Cena
4445110	150/10	P-1 / foil bag 120x180	0,006	4445110	3,50 zł

32. ACTIV PLUS
Zawór grzejnikowy prosty zasilający nikielowany

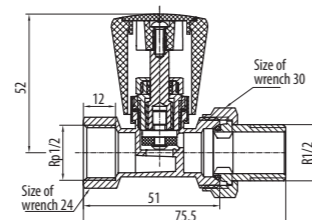

Kod	Kolor	Wymiar	P nom. / T max	Ilość szt.	Opakow.	Waga netto	Kod	Cena
4482070	NIKLOWANY	1/2"	PN 10 / 100°C	100/10	P-4482.07/2 / P-4482.07/1	0,186	4482070	29,90 zł
4482080	BIAŁY	1/2"	PN 10 / 100°C	100/10	P-4482.07/2 / P-4482.07/1	0,186	4482080	38,60 zł

33. ACTIV PLUS
Zawór grzejnikowy kątowy zasilający nikielowany

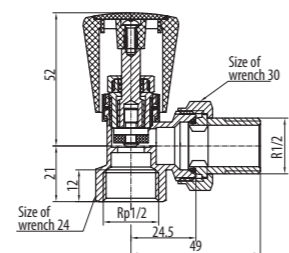

Kod	Kolor	Wymiar	P nom. / T max	Ilość szt.	Opakow.	Waga netto	Kod	Cena
4582070	NIKLOWANY	1/2"	PN 10 / 100°C	100/10	P-4482.07/2 / P-4482.07/1	0,174	4582070	29,90 zł
4582080	BIAŁY	1/2"	PN 10 / 100°C	100/10	P-4482.07/2 / P-4482.07/1	0,174	4582080	38,60 zł

34. ACTIV
Zawór grzejnikowy prosty zasilający nikielowany

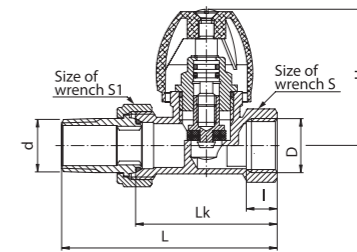

DN	Kod	Kolor	Wymiary										P nom. / T max	Ilość szt.	Opakow.	Waga netto	Kod	Cena
			Wymiar	D	d	L	Lk	I	H	S	S1							
10	4481050	NIKLOWANY	3/8"	Rp3/8	R3/8	75	50	10	51	22	26	26	PN 10 / 100°C	20	P-43	0,198	4481050	35,10 zł
15	4482050	NIKLOWANY	1/2"	Rp1/2	R1/2	82	55	12	52	26	30	PN 10 / 100°C	25	P-1	0,238	4482050	35,50 zł	
20	4483050	NIKLOWANY	3/4"	Rp3/4	R3/4	96,5	65	12	53	32	37	PN 10 / 100°C	10	P-43	0,321	4483050	52,90 zł	
15	4482250	BIAŁY	1/2"	Rp1/2	R1/2	82	55	12	52	26	30	PN 10 / 100°C	25	P-1	0,238	4482250	45,40 zł	

35. ACTIV
Zawór grzejnikowy kątowy zasilający nikielowany

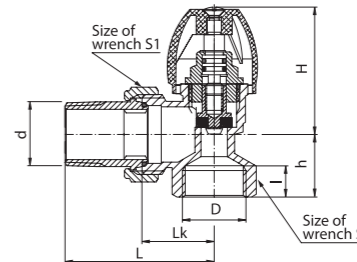

DN	Kod	Kolor	Wymiary										P nom. / T max	Ilość szt.	Opakow.	Waga netto	Kod	Cena
			Wymiar	D	d	L	Lk	I	H	h	S	S1						
10	4581050	NIKLOWANY	3/8"	Rp3/8	R3/8	49	24	10	51	20	22	26	PN 10 / 100°C	20	P-43	0,192	4581050	28,70 zł
15	4582050	NIKLOWANY	1/2"	Rp1/2	R1/2	53	26	12	52	23	26	30	PN 10 / 100°C	25	P-1	0,219	4582050	35,50 zł
20	4583050	NIKLOWANY	3/4"	Rp3/4	R3/4	63	31,5	12	52	26	32	37	PN 10 / 100°C	10	P-43	0,301	4583050	57,40 zł
15	4582250	BIAŁY	1/2"	Rp1/2	R1/2	53	26	12	52	23	26	30	PN 10 / 100°C	25	P-1	0,219	4582250	45,40 zł

36. ACTIV PLUS
Zestaw grzejnikowy tradycyjny prosty



Rys. techn.:
• poz. 32
• poz. 9



Kod	Kolor	Wymiar	P nom. / T max	Ilość szt.	Opakow.	Waga netto	Kod	Cena
4412680	NIKLOWANY	1/2"	PN 10 / 100°C	20/1	P-42 / EN 56x145	0,346	4412680	51,00 zł
4412690	BIAŁY	1/2"	PN 10 / 100°C	40/1	P-4412.69 / Blister 4412.69	0,346	4412690	65,90 zł

37. ACTIV PLUS
Zestaw grzejnikowy tradycyjny kątowy



Rys. techn.:
• poz. 33
• poz. 10



Kod	Kolor	Wymiar	P nom. / T max	Ilość szt.	Opakow.	Waga netto	Kod	Cena
4512680	NIKLOWANY	1/2"	PN 10 / 100°C	20/1	P-42 / EN 56x145	0,324	4512680	52,00 zł
4512690	BIAŁY	1/2"	PN 10 / 100°C	40/1	P-4412.69 / Blister 4412.69	0,324	4512690	67,40 zł

38. **ACTIV**
Zestaw grzejnikowy tradycyjny prosty, niklowany



Rys. techn.:
• poz. 34
• poz. 9

Kod	Wymiar	P nom. / T max	Ilość szt.	Opakow.	Waga netto	Kod	Cena
4412580	1/2"	PN 10 / 100°C	20/1	P-42 / EN 56x145	0,401	4412580	57,20 zł

39. **ACTIV**
Zestaw grzejnikowy tradycyjny kątowy, niklowany



Rys. techn.:
• poz. 35
• poz. 10

Kod	Wymiar	P nom. / T max	Ilość szt.	Opakow.	Waga netto	Kod	Cena
4512580	1/2"	PN 10 / 100°C	20/1	P-42 / EN 56x145	0,373	4512580	57,20 zł

40. **ALFA**
Automatyczny zawór odpowietrzający z zaworem odcinającym

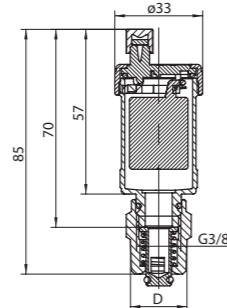

Kod	Kolor	Wymiar - D	P nom. / T max	Ilość szt.	Opakow.	Waga netto	Kod	Cena
4700360	ŚRUTOWANY	1/2"	PN 10 / 110°C	40/1	P-1 / P-19	0,137	4700360	33,70 zł
4700160	ŚRUTOWANY	3/8"	PN 10 / 110°C	40/1	P-1 / P-19	0,137	4700160	33,70 zł
4700330	NIKLOWANY	1/2"	PN 10 / 110°C	40/1	P-1 / P-19	0,137	4700330	36,70 zł
4700170	NIKLOWANY	3/8"	PN 10 / 110°C	40/1	P-1 / P-19	0,137	4700170	36,70 zł
4700230	BIAŁY	1/2"	PN 10 / 110°C	40/1	P-1 / P-19	0,137	4700230	42,30 zł

41. **BETA**
Zawór odpowietrzający niklowany

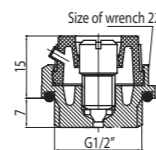

Kod	Wymiar	P nom. / T max	Ilość szt.	Opakow.	Waga netto	Kod	Cena
4700200	P-G1/2"	PN 10 / 100°C	240/30/10	P-1 / P-14	0,019	4700200	4,10 zł

42. **GAMMA**
Zawór odpowietrzający kątowy

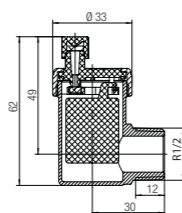

Kod	Wymiar	P nom. / T max	Ilość szt.	Opakow.	Waga netto	Kod	Cena	
4700740	NIKLOWANY	P-G1/2"	PN 10 / 110°C	40/1	P-1/PK38	0,099	4700740	22,70 zł
4700750	BIAŁY	P-G1/2"	PN 10 / 110°C	40/1	P-1/PK38	0,099	4700750	31,80 zł

43. **PIZA**
Filtr skośny do wody mosiężny

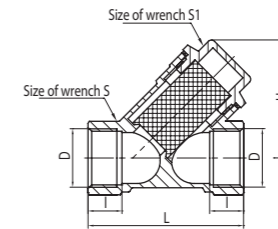

DN	Kod	Wymiary								P nom. / T max	Ilość szt.	Opakow.	Waga netto	Kod	Cena
		Wymiar	D	L	I	H	S	S1							
15	4990000	1/2"	G1/2	55	12	40	25	20	PN 25 / 110°C	90/15	P-43	0,144	4990000	19,60 zł	
20	4990010	3/4"	G3/4	66	12	50	30	23	PN 25 / 110°C	60/10	P-1	0,205	4990010	30,60 zł	
25	4990020	1"	G1	74	12	52	37	23	PN 25 / 110°C	48/8	P-1	0,296	4990020	44,40 zł	
32	4990030	1 1/4"	G1 1/4	94,5	14	63	48	32	PN 25 / 110°C	5	P-1	0,569	4990030	83,60 zł	
40	4990040	1 1/2"	G1 1/2	100	15	72	55	38	PN 25 / 110°C	3	P-1	0,793	4990040	110,60 zł	
50	4990050	2"	G2	113	15	88	68	45	PN 25 / 110°C	2	P-1	1,292	4990050	190,10 zł	

44. **PROFF**
Belka rozdzielacza

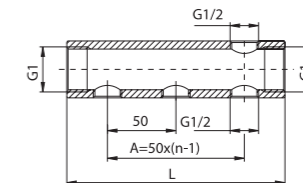

Kod	Wymiary				P nom. / T max	Ilość szt.	Opakow.	Waga netto	Kod	Cena
	Wymiar	n	A	L						
6087500	G1-G1/2	2	50	100	PN 10 / 95°C	32	P-6086.03	0.330	6087500	43,20 zł
6087510	G1-G1/2	3	100	150	PN 10 / 95°C	20	P-6086.03	0.512	6087510	63,40 zł
6087520	G1-G1/2	4	150	200	PN 10 / 95°C	16	P-6086.03	0.697	6087520	83,80 zł
6087530	G1-G1/2	5	200	250	PN 10 / 95°C	22	P-6086.06	0.888	6087530	104,30 zł
6087540	G1-G1/2	6	250	300	PN 10 / 95°C	18	P-6086.06	1.074	6087540	125,80 zł
6087550	G1-G1/2	7	300	350	PN 10 / 95°C	16	P-6086.06	1.244	6087550	149,00 zł
6087560	G1-G1/2	8	350	400	PN 10 / 95°C	16	P-6086.09	1.440	6087560	171,20 zł
6087570	G1-G1/2	9	400	450	PN 10 / 95°C	16	P-6086.09	1.621	6087570	199,40 zł
6087580	G1-G1/2	10	450	500	PN 10 / 95°C	16	P-6086.09	1.807	6087580	226,40 zł
6087590	G1-G1/2	11	500	550	PN 10 / 95°C	16	P-6086.11	1.984	6087590	241,40 zł
6087600	G1-G1/2	12	550	600	PN 10 / 95°C	16	P-6086.11	2.173	6087600	274,20 zł

45. **PROFF**
Zespół rozdzielaczy PROFF K1

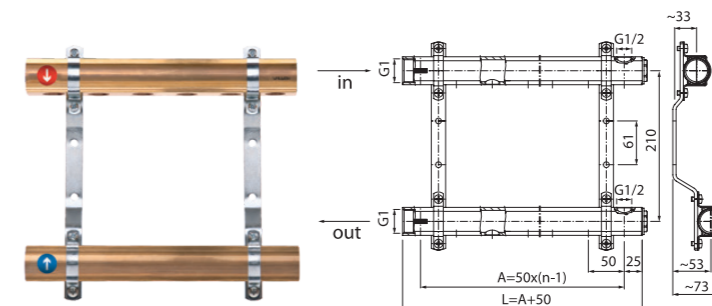

Kod	Wymiary				P nom. / T max	Ilość szt.	Opakow.	Waga netto	Kod	Cena
	Wymiar	n	A	L						
6086010	G1-G1/2	2	50	100	PN 10 / 95°C	1	P-6086.03	1.006	6086010	131,10 zł
6086020	G1-G1/2	3	100	150	PN 10 / 95°C	1	P-6086.03	1.622	6086020	192,90 zł
6086030	G1-G1/2	4	150	200	PN 10 / 95°C	1	P-6086.03	1.989	6086030	230,30 zł
6086040	G1-G1/2	5	200	250	PN 10 / 95°C	1	P-6086.06	2.378	6086040	277,10 zł
6086050	G1-G1/2	6	250	300	PN 10 / 95°C	1	P-6086.06	2.743	6086050	318,30 zł
6086060	G1-G1/2	7	300	350	PN 10 / 95°C	1	P-6086.06	3.102	6086060	359,40 zł
6086070	G1-G1/2	8	350	400	PN 10 / 95°C	1	P-6086.09	3.467	6086070	406,20 zł
6086080	G1-G1/2	9	400	450	PN 10 / 95°C	1	P-6086.09	3.854	6086080	464,60 zł
6086090	G1-G1/2	10	450	500	PN 10 / 95°C	1	P-6086.09	4.226	6086090	515,00 zł
6086100	G1-G1/2	11	500	550	PN 10 / 95°C	1	P-6086.11	4.571	6086100	545,00 zł
6086110	G1-G1/2	12	550	600	PN 10 / 95°C	1	P-6086.11	4.940	6086110	606,60 zł

46. PROFF
Zespół rozdzielaczy PROFF
K2

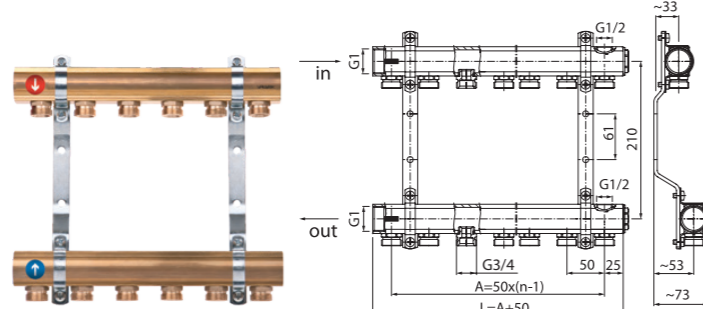

Kod	Wymiary				P nom. / T max	Ilość szt.	Opakow.	Waga netto	Kod	Cena
	Wymiar	n	A	L						
6086260	G1-G3/4	2	50	100	PN 10 / 95°C	1	P-6086.03	1.193	6086260	164,20 zł
6086270	G1-G3/4	3	100	150	PN 10 / 95°C	1	P-6086.03	1.912	6086270	240,60 zł
6086280	G1-G3/4	4	150	200	PN 10 / 95°C	1	P-6086.03	2.373	6086280	295,90 zł
6086290	G1-G3/4	5	200	250	PN 10 / 95°C	1	P-6086.06	2.837	6086290	350,00 zł
6086300	G1-G3/4	6	250	300	PN 10 / 95°C	1	P-6086.06	3.315	6086300	402,60 zł
6086310	G1-G3/4	7	300	350	PN 10 / 95°C	1	P-6086.06	3.750	6086310	462,50 zł
6086320	G1-G3/4	8	350	400	PN 10 / 95°C	1	P-6086.09	4.214	6086320	520,70 zł
6086330	G1-G3/4	9	400	450	PN 10 / 95°C	1	P-6086.09	4.687	6086330	604,90 zł
6086340	G1-G3/4	10	450	500	PN 10 / 95°C	1	P-6086.09	5.152	6086340	668,10 zł
6086350	G1-G3/4	11	500	550	PN 10 / 95°C	1	P-6086.11	5.591	6086350	715,80 zł
6086360	G1-G3/4	12	550	600	PN 10 / 95°C	1	P-6086.11	6.053	6086360	792,20 zł

47. PROFF
Zespół rozdzielaczy PROFF K2 MINI

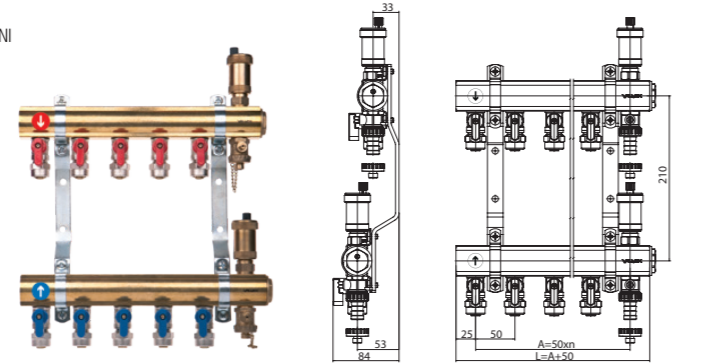

Kod	Wymiary				P nom. / T max	Ilość szt.	Opakow.	Waga netto	Kod	Cena
	Wymiar	n	A	L						
6084300	G1 - PEX 16x2	2	100	150	PN 10 / 95°C	1	P-6086.03	2.461	6084300	360,60 zł
6084310	G1 - PEX 16x2	3	150	200	PN 10 / 95°C	1	P-6086.03	3.279	6084310	447,80 zł
6084320	G1 - PEX 16x2	4	200	250	PN 10 / 95°C	1	P-6086.06	3.931	6084320	535,20 zł
6084330	G1 - PEX 16x2	5	250	300	PN 10 / 95°C	1	P-6086.06	4.596	6084330	629,50 zł
6084340	G1 - PEX 16x2	6	300	350	PN 10 / 95°C	1	P-6086.06	5.260	6084340	718,60 zł
6084350	G1 - PEX 16x2	7	350	400	PN 10 / 95°C	1	P-6086.09	5.924	6084350	803,80 zł
6084360	G1 - PEX 16x2	8	400	450	PN 10 / 95°C	1	P-6086.09	6.588	6084360	898,10 zł
6084370	G1 - PEX 16x2	9	450	500	PN 10 / 95°C	1	P-6086.09	7.253	6084370	995,90 zł
6084380	G1 - PEX 16x2	10	500	550	PN 10 / 95°C	1	P-6086.11	7.917	6084380	1 091,10 zł
6084390	G1 - PEX 16x2	11	550	600	PN 10 / 95°C	1	P-6086.11	8.581	6084390	1 170,60 zł

48. PROFF
Zespół rozdzielaczy PROFF
K3

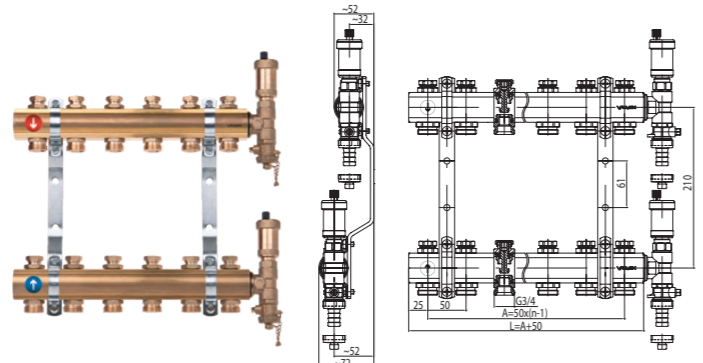

Kod	Wymiary				P nom. / T max	Ilość szt.	Opakow.	Waga netto	Kod	Cena
	Wymiar	n	A	L						
6086500	G1-G3/4	2	50	100	PN 10 / 95°C	1	P-6086.03	1.907	6086500	325,70 zł
6086510	G1-G3/4	3	100	150	PN 10 / 95°C	1	P-6086.03	3.021	6086510	393,60 zł
6086520	G1-G3/4	4	150	200	PN 10 / 95°C	1	P-6086.03	3.674	6086520	456,30 zł
6086530	G1-G3/4	5	200	250	PN 10 / 95°C	1	P-6086.06	4.320	6086530	524,50 zł
6086540	G1-G3/4	6	250	300	PN 10 / 95°C	1	P-6086.06	4.980	6086540	598,00 zł
6086550	G1-G3/4	7	300	350	PN 10 / 95°C	1	P-6086.06	5.638	6086550	666,10 zł
6086560	G1-G3/4	8	350	400	PN 10 / 95°C	1	P-6086.09	6.297	6086560	734,20 zł
6086570	G1-G3/4	9	400	450	PN 10 / 95°C	1	P-6086.09	6.955	6086570	816,00 zł
6086580	G1-G3/4	10	450	500	PN 10 / 95°C	1	P-6086.09	7.614	6086580	897,60 zł
6086590	G1-G3/4	11	500	550	PN 10 / 95°C	1	P-6086.11	8.273	6086590	965,70 zł
6086600	G1-G3/4	12	550	600	PN 10 / 95°C	1	P-6086.11	8.931	6086600	1 061,10 zł

49. PROFF
Zespół rozdzielaczy PROFF
K4

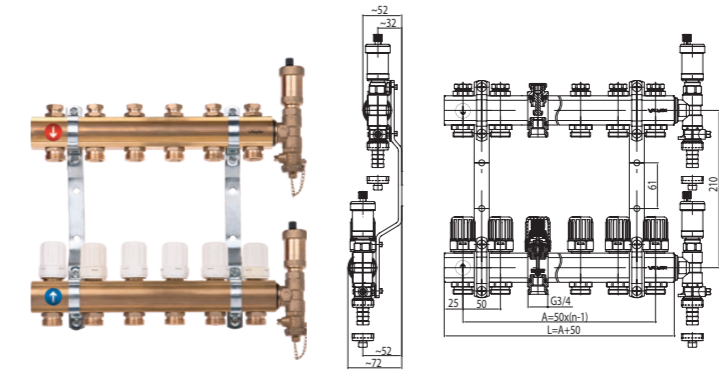

Kod	Wymiary				P nom. / T max	Ilość szt.	Opakow.	Waga netto	Kod	Cena
	Wymiar	n	A	L						
6086630	G1-G3/4	2	50	100	PN 10 / 95°C	1	P-6086.03	1.937	6086630	339,30 zł
6086640	G1-G3/4	3	100	150	PN 10 / 95°C	1	P-6086.03	3.066	6086640	403,30 zł
6086650	G1-G3/4	4	150	200	PN 10 / 95°C	1	P-6086.06	3.734	6086650	476,90 zł
6086660	G1-G3/4	5	200	250	PN 10 / 95°C	1	P-6086.06	4.395	6086660	557,10 zł
6086670	G1-G3/4	6	250	300	PN 10 / 95°C	1	P-6086.06	5.070	6086670	632,10 zł
6086680	G1-G3/4	7	300	350	PN 10 / 95°C	1	P-6086.09	5.743	6086680	702,80 zł
6086690	G1-G3/4	8	350	400	PN 10 / 95°C	1	P-6086.09	6.417	6086690	783,20 zł
6086700	G1-G3/4	9	400	450	PN 10 / 95°C	1	P-6086.09	7.090	6086700	866,40 zł
6086710	G1-G3/4	10	450	500	PN 10 / 95°C	1	P-6086.11	7.764	6086710	948,00 zł
6086720	G1-G3/4	11	500	550	PN 10 / 95°C	1	P-6086.11	8.438	6086720	1 013,10 zł
6086730	G1-G3/4	12	550	600	PN 10 / 95°C	1	P-6086.11	9.111	6086730	1 108,30 zł

50. PROFF
Zespół rozdzielaczy PROFF
K5

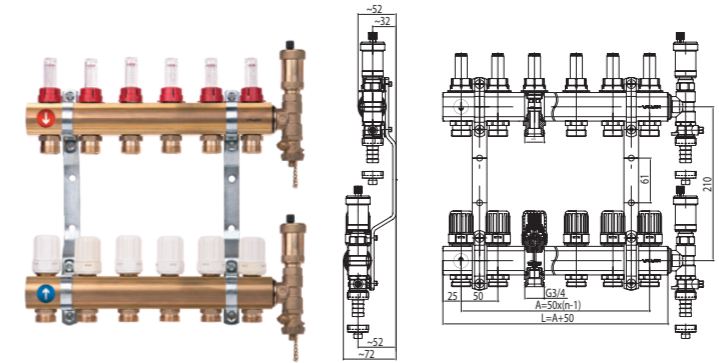

Kod	Wymiary				P nom. / T max	Ilość szt.	Opakow.	Waga netto	Kod	Cena
	Wymiar	n	A	L						
6086750	G1-G3/4	2	50	100	PN 6 / 70°C	1	P-6086.75	3.029	6086750	393,60 zł
6086760	G1-G3/4	3	100	150	PN 6 / 70°C	1	P-6086.75	3.685	6086760	448,30 zł
6086770	G1-G3/4	4	150	200	PN 6 / 70°C	1	P-6086.75	4.334	6086770	543,50 zł
6086780	G1-G3/4	5	200	250	PN 6 / 70°C	1	P-6086.78	4.996	6086780	621,00 zł
6086790	G1-G3/4	6	250	300	PN 6 / 70°C	1	P-6086.78	5.657	6086790	708,30 zł
6086800	G1-G3/4	7	300	350	PN 6 / 70°C	1	P-6086.78	6.318	6086800	816,00 zł
6086810	G1-G3/4	8	350	400	PN 6 / 70°C	1	P-6086.81	6.980	6086810	897,60 zł
6086820	G1-G3/4	9	400	450	PN 6 / 70°C	1	P-6086.81	7.641	6086820	994,40 zł
6086830	G1-G3/4	10	450	500	PN 6 / 70°C	1	P-6086.81	8.302	6086830	1 110,30 zł
6086840	G1-G3/4	11	500	550	PN 6 / 70°C	1	P-6086.84	8.964	6086840	1 189,60 zł
6086850	G1-G3/4	12	550	600	PN 6 / 70°C	1	P-6086.84	9.111	6086850	1 308,70 zł

51. BASE
Belka rozdzielacza BASE INOX

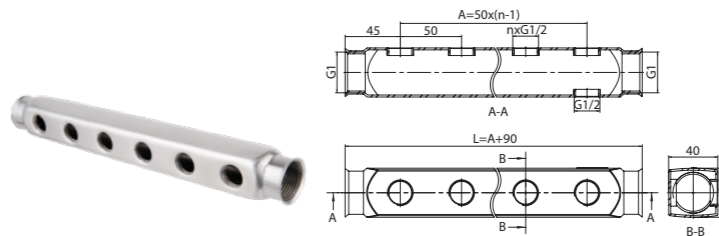

Kod	Wymiary				P nom. / T max	Ilość szt.	Opakow.	Waga netto	Kod	Cena
	Wymiar	n	A	L						
6085870	G1-G1/2	2	50	140	PN 10 / 95°C	24	P-6085.00	0.266	6085870	36,30 zł
6085880	G1-G1/2	3	100	190	PN 10 / 95°C	16	P-6085.00	0.358	6085880	50,70 zł
6085890	G1-G1/2	4	150	240	PN 10 / 95°C	14	P-6085.00	0.450	6085890	62,40 zł
6085900	G1-G1/2	5	200	290	PN 10 / 95°C	14	P-6085.03	0.542	6085900	72,60 zł
6085910	G1-G1/2	6	250	340	PN 10 / 95°C	14	P-6085.03	0.634	6085910	83,10 zł
6085920	G1-G1/2	7	300	390	PN 10 / 95°C	14	P-6085.03	0.726	6085920	93,50 zł
6085930	G1-G1/2	8	350	440	PN 10 / 95°C	14	P-6085.07	0.818	6085930	103,70 zł
6085940	G1-G1/2	9	400	490	PN 10 / 95°C	14	P-6085.07	0.910	6085940	114,20 zł
6085950	G1-G1/2	10	450	540	PN 10 / 95°C	14	P-6085.07	1.002	6085950	124,70 zł
6085960	G1-G1/2	11	500	590	PN 10 / 95°C	14	P-6085.10	1.094	6085960	134,90 zł
6085970	G1-G1/2	12	550	640	PN 10 / 95°C	14	P-6085.10	1.184	6085970	145,50 zł

52. BASE
Zespół rozdzielaczy BASE INOX K1

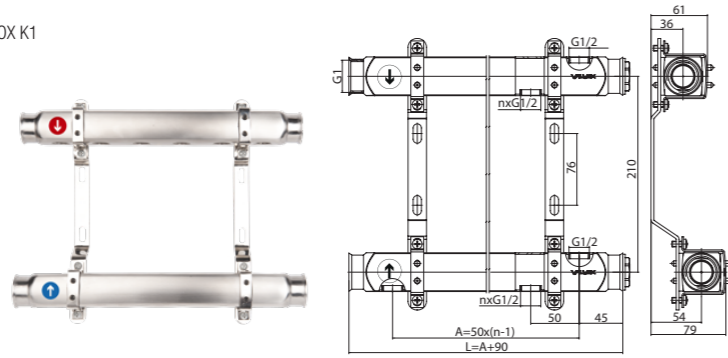

Kod	Wymiary				P nom. / T max	Ilość szt.	Opakow.	Waga netto	Kod	Cena
	Wymiar	n	A	L						
6085000	G1-G1/2	2	50	140	PN 10 / 95°C	1	P-6085.00	0.793	6085000	121,80 zł
6085010	G1-G1/2	3	100	190	PN 10 / 95°C	1	P-6085.00	1.137	6085010	140,50 zł
6085020	G1-G1/2	4	150	240	PN 10 / 95°C	1	P-6085.00	1.321	6085020	157,40 zł
6085030	G1-G1/2	5	200	290	PN 10 / 95°C	1	P-6085.03	1.505	6085030	178,70 zł
6085040	G1-G1/2	6	250	340	PN 10 / 95°C	1	P-6085.03	1.689	6085040	197,10 zł
6085050	G1-G1/2	7	300	390	PN 10 / 95°C	1	P-6085.03	1.873	6085050	226,30 zł
6085060	G1-G1/2	8	350	440	PN 10 / 95°C	1	P-6085.07	2.057	6085060	248,70 zł
6085070	G1-G1/2	9	400	490	PN 10 / 95°C	1	P-6085.07	2.241	6085070	276,60 zł
6085080	G1-G1/2	10	450	540	PN 10 / 95°C	1	P-6085.07	2.425	6085080	305,60 zł
6085090	G1-G1/2	11	500	590	PN 10 / 95°C	1	P-6085.10	2.609	6085090	336,10 zł
6085100	G1-G1/2	12	550	640	PN 10 / 95°C	1	P-6085.10	2.789	6085100	382,30 zł

53. BASE
Zespół rozdzielaczy BASE INOX K2

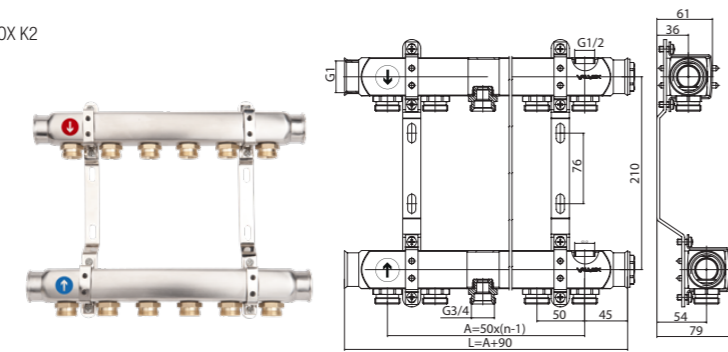

Kod	Wymiary				P nom. / T max	Ilość szt.	Opakow.	Waga netto	Kod	Cena
	Wymiar	n	A	L						
6085150	G1-G3/4	2	50	140	PN 10 / 95°C	1	P-6085.00	1.185	6085150	146,00 zł
6085160	G1-G3/4	3	100	190	PN 10 / 95°C	1	P-6085.00	1.485	6085160	172,90 zł
6085170	G1-G3/4	4	150	240	PN 10 / 95°C	1	P-6085.00	1.785	6085170	203,60 zł
6085180	G1-G3/4	5	200	290	PN 10 / 95°C	1	P-6085.03	2.085	6085180	239,70 zł
6085190	G1-G3/4	6	250	340	PN 10 / 95°C	1	P-6085.03	2.385	6085190	273,20 zł
6085200	G1-G3/4	7	300	390	PN 10 / 95°C	1	P-6085.03	2.685	6085200	306,70 zł
6085210	G1-G3/4	8	350	440	PN 10 / 95°C	1	P-6085.07	2.985	6085210	346,90 zł
6085220	G1-G3/4	9	400	490	PN 10 / 95°C	1	P-6085.07	3.285	6085220	396,40 zł
6085230	G1-G3/4	10	450	540	PN 10 / 95°C	1	P-6085.07	3.585	6085230	436,60 zł
6085240	G1-G3/4	11	500	590	PN 10 / 95°C	1	P-6085.10	3.885	6085240	480,80 zł
6085250	G1-G3/4	12	550	640	PN 10 / 95°C	1	P-6085.10	4.181	6085250	521,10 zł

54. BASE
Zespół rozdzielaczy BASE INOX K2MINI

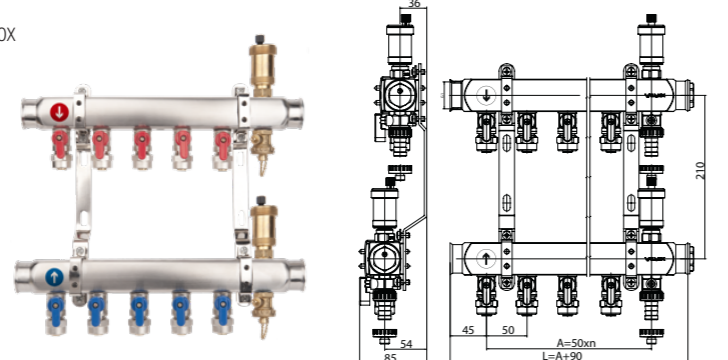

Kod	Wymiary				P nom. / T max	Ilość szt.	Opakow.	Waga netto	Kod	Cena
	Wymiar	n	A	L						
6084000	G1-PEX 16x2	2	100	190	PN 10 / 95°C	1	P-6085.00	2.033	6084000	296,10 zł
6084010	G1-PEX 16x2	3	150	240	PN 10 / 95°C	1	P-6085.00	2.650	6084010	363,70 zł
6084020	G1-PEX 16x2	4	200	290	PN 10 / 95°C	1	P-6085.03	3.109	6084020	431,30 zł
6084030	G1-PEX 16x2	5	250	340	PN 10 / 95°C	1	P-6085.03	3.567	6084030	507,20 zł
6084040	G1-PEX 16x2	6	300	390	PN 10 / 95°C	1	P-6085.03	4.025	6084040	574,50 zł
6084050	G1-PEX 16x2	7	350	440	PN 10 / 95°C	1	P-6085.07	4.484	6084050	647,60 zł
6084060	G1-PEX 16x2	8	400	490	PN 10 / 95°C	1	P-6085.07	4.942	6084060	715,20 zł
6084070	G1-PEX 16x2	9	450	540	PN 10 / 95°C	1	P-6085.07	5.401	6084070	788,20 zł
6084080	G1-PEX 16x2	10	500	590	PN 10 / 95°C	1	P-6085.10	5.859	6084080	858,50 zł
6084090	G1-PEX 16x2	11	550	640	PN 10 / 95°C	1	P-6085.10	6.313	6084090	926,20 zł

55. BASE
Zespół rozdzielaczy BASE INOX K2MINI PLUS

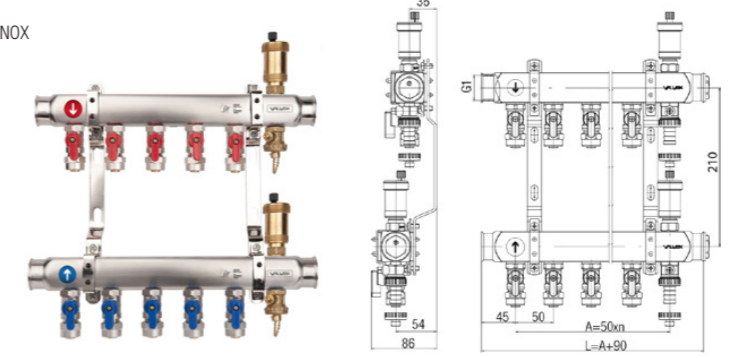

Kod	Wymiary				P nom. / T max	Ilość szt.	Opakow.	Waga netto	Kod	Cena
	Wymiar	n	A	L						
6081300	G1-PEX 16x2	2	100	190	PN 10 / 95°C	1	P-6085.00	2.360	6081300	296,10 zł
6081310	G1-PEX 16x2	3	150	240	PN 10 / 95°C	1	P-6085.00	2.902	6081310	363,70 zł
6081320	G1-PEX 16x2	4	200	290	PN 10 / 95°C	1	P-6085.03	3.444	6081320	431,30 zł
6081330	G1-PEX 16x2	5	250	340	PN 10 / 95°C	1	P-6085.03	3.986	6081330	507,20 zł
6081340	G1-PEX 16x2	6	300	390	PN 10 / 95°C	1	P-6085.03	4.528	6081340	574,50 zł
6081350	G1-PEX 16x2	7	350	440	PN 10 / 95°C	1	P-6085.07	5.070	6081350	647,60 zł
6081360	G1-PEX 16x2	8	400	490	PN 10 / 95°C	1	P-6085.07	5.612	6081360	715,20 zł
6081370	G1-PEX 16x2	9	450	540	PN 10 / 95°C	1	P-6085.07	6.154	6081370	788,20 zł
6081380	G1-PEX 16x2	10	500	590	PN 10 / 95°C	1	P-6085.10	6.696	6081380	858,50 zł
6081390	G1-PEX 16x2	11	550	640	PN 10 / 95°C	1	P-6085.10	7.234	6081390	926,20 zł

56. BASE
Zespół rozdzielaczy BASE INOX K3

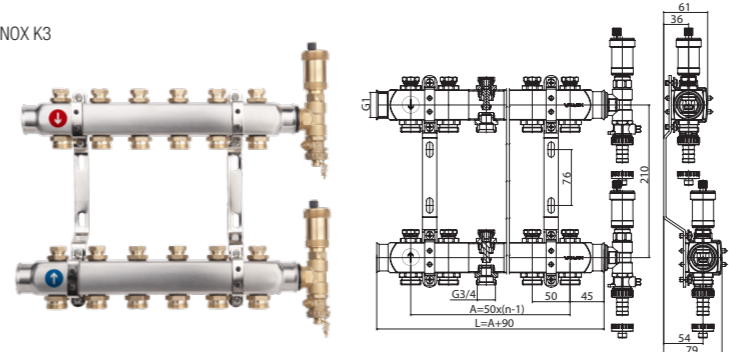

Kod	Wymiary				P nom. / T max	Ilość szt.	Opakow.	Waga netto	Kod	Cena
	Wymiar	n	A	L						
6085300	G1-G3/4	2	50	140	PN 10 / 95°C	1	P-6085.00	2.003	6085300	289,50 zł
6085310	G1-G3/4	3	100	190	PN 10 / 95°C	1	P-6085.00	2.635	6085310	343,50 zł
6085320	G1-G3/4	4	150	240	PN 10 / 95°C	1	P-6085.00	2.947	6085320	390,70 zł
6085330	G1-G3/4	5	200	290	PN 10 / 95°C	1	P-6085.03	3.579	6085330	444,90 zł
6085340	G1-G3/4	6	250	340	PN 10 / 95°C	1	P-6085.03	4.051	6085340	498,90 zł
6085350	G1-G3/4	7	300	390	PN 10 / 95°C	1	P-6085.03	4.523	6085350	566,30 zł
6085360	G1-G3/4	8	350	440	PN 10 / 95°C	1	P-6085.07	4.995	6085360	620,50 zł
6085370	G1-G3/4	9	400	490	PN 10 / 95°C	1	P-6085.07	5.467	6085370	688,10 zł
6085380	G1-G3/4	10	450	540	PN 10 / 95°C	1	P-6085.07	5.939	6085380	750,40 zł
6085390	G1-G3/4	11	500	590	PN 10 / 95°C	1	P-6085.10	6.411	6085390	809,80 zł
6085400	G1-G3/4	12	550	640	PN 10 / 95°C	1	P-6085.10	6.881	6085400	884,20 zł

57. BASE
Zespół rozdzielaczy BASE INOX K4

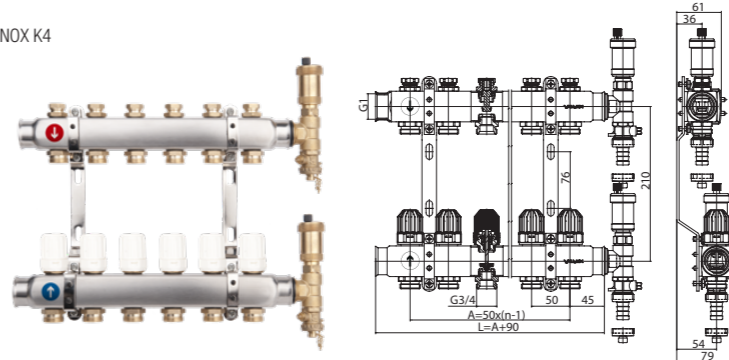

Kod	Wymiary				P nom. / T max	Ilość szt.	Opakow.	Waga netto	Kod	Cena
	Wymiar	n	A	L						
6085450	G1-G3/4	2	50	140	PN 10 / 95°C	1	P-6085.00	2.033	6085450	323,10 zł
6085460	G1-G3/4	3	100	190	PN 10 / 95°C	1	P-6085.00	2.680	6085460	377,30 zł
6085470	G1-G3/4	4	150	240	PN 10 / 95°C	1	P-6085.00	3.167	6085470	433,90 zł
6085480	G1-G3/4	5	200	290	PN 10 / 95°C	1	P-6085.03	3.654	6085480	485,20 zł
6085490	G1-G3/4	6	250	340	PN 10 / 95°C	1	P-6085.03	4.141	6085490	539,50 zł
6085500	G1-G3/4	7	300	390	PN 10 / 95°C	1	P-6085.03	4.628	6085500	603,00 zł
6085510	G1-G3/4	8	350	440	PN 10 / 95°C	1	P-6085.07	5.115	6085510	661,10 zł
6085520	G1-G3/4	9	400	490	PN 10 / 95°C	1	P-6085.07	5.602	6085520	723,30 zł
6085530	G1-G3/4	10	450	540	PN 10 / 95°C	1	P-6085.07	6.089	6085530	805,90 zł
6085540	G1-G3/4	11	500	590	PN 10 / 95°C	1	P-6085.10	6.576	6085540	877,50 zł
6085550	G1-G3/4	12	550	640	PN 10 / 95°C	1	P-6085.10	7.061	6085550	944,90 zł

58. BASE
Zespół rozdzielaczy BASE INOX K5

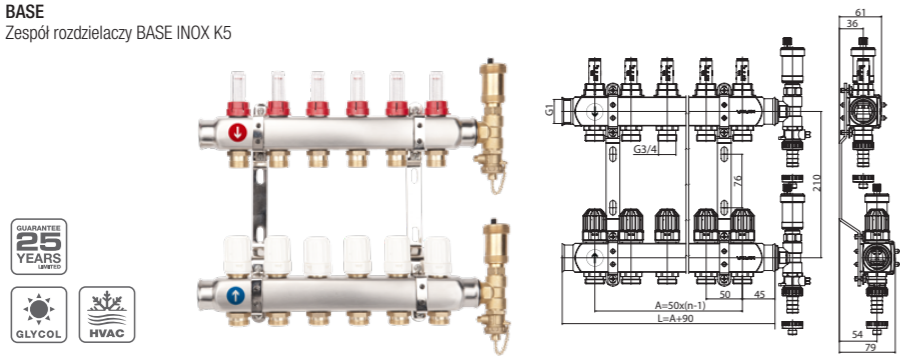

Kod	Wymiary				P nom. / T max	Ilość szt.	Opakow.	Waga netto	Kod	Cena
	Wymiar	n	A	L						
6085600	G1-G3/4	2	50	140	PN 6 / 70°C	1	P-6085.60	2.009	6085600	350,10 zł
6085610	G1-G3/4	3	100	190	PN 6 / 70°C	1	P-6085.60	2.643	6085610	417,90 zł
6085620	G1-G3/4	4	150	240	PN 6 / 70°C	1	P-6085.60	3.117	6085620	471,90 zł
6085630	G1-G3/4	5	200	290	PN 6 / 70°C	1	P-6085.63	3.592	6085630	539,50 zł
6085640	G1-G3/4	6	250	340	PN 6 / 70°C	1	P-6085.63	4.067	6085640	620,50 zł
6085650	G1-G3/4	7	300	390	PN 6 / 70°C	1	P-6085.63	4.542	6085650	688,10 zł
6085660	G1-G3/4	8	350	440	PN 6 / 70°C	1	P-6085.66	5.016	6085660	769,20 zł
6085670	G1-G3/4	9	400	490	PN 6 / 70°C	1	P-6085.66	5.491	6085670	836,80 zł
6085680	G1-G3/4	10	450	540	PN 6 / 70°C	1	P-6085.66	5.966	6085680	931,40 zł
6085690	G1-G3/4	11	500	590	PN 6 / 70°C	1	P-6085.69	6.440	6085690	1 026,10 zł
6085700	G1-G3/4	12	550	640	PN 6 / 70°C	1	P-6085.69	6.913	6085700	1 145,20 zł

59. BASE
Zespół rozdzielaczy BASE INOX K5 PLUS

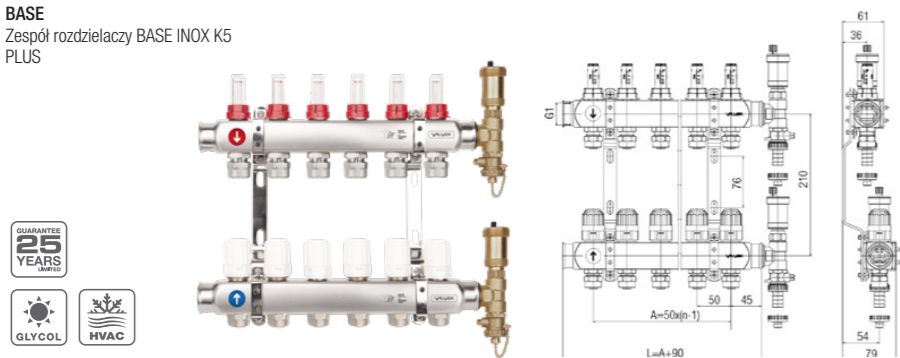

Kod	Wymiary				P nom. / T max	Ilość szt.	Opakow.	Waga netto	Kod	Cena
	Wymiar	n	A	L						
6081450	G1 - PEX 16x2	2	50	140	PN 10/95°C	1	P-6085.60	2.097	6081450	350,10 zł
6081460	G1 - PEX 16x2	3	100	190	PN 10/95°C	1	P-6085.60	2.777	6081460	417,90 zł
6081470	G1 - PEX 16x2	4	150	240	PN 10/95°C	1	P-6085.60	3.297	6081470	471,90 zł
6081480	G1 - PEX 16x2	5	200	290	PN 10/95°C	1	P-6085.63	3.818	6081480	539,50 zł
6081490	G1 - PEX 16x2	6	250	340	PN 10/95°C	1	P-6085.63	4.339	6081490	620,50 zł
6081500	G1 - PEX 16x2	7	300	390	PN 10/95°C	1	P-6085.63	4.860	6081500	688,10 zł
6081510	G1 - PEX 16x2	8	350	440	PN 10/95°C	1	P-6085.66	5.380	6081510	769,20 zł
6081520	G1 - PEX 16x2	9	400	490	PN 10/95°C	1	P-6085.66	5.901	6081520	836,80 zł
6081530	G1 - PEX 16x2	10	450	540	PN 10/95°C	1	P-6085.66	6.422	6081530	931,40 zł
6081540	G1 - PEX 16x2	11	500	590	PN 10/95°C	1	P-6085.69	6.942	6081540	1 026,10 zł
6081550	G1 - PEX 16x2	12	550	640	PN 10/95°C	1	P-6085.69	7.459	6081550	1 145,20 zł

60. BASE + PROFF
Zestaw rozdzielaczy BASE K5 z grupą pompowo-mieszającą PROFF

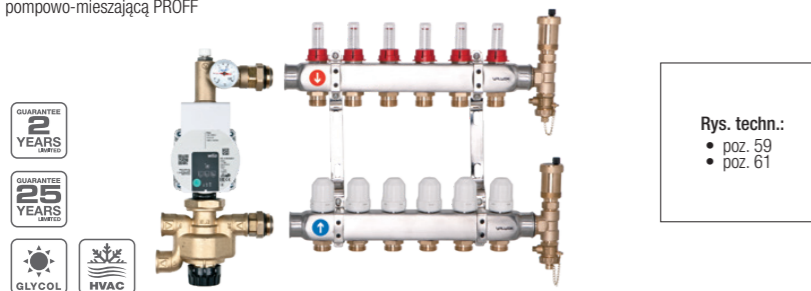

Kod	Wymiary				P nom. / T max	Ilość szt.	Opakow.	Waga netto	Kod	Cena
	Wymiar	n	A	L						
6088650	G1-G3/4	2	50	140	PN 6 / 70°C	1	P-6085.60	5.893	6088650	2 052,20 zł
6088660	G1-G3/4	3	100	190	PN 6 / 70°C	1	P-6085.60	6.527	6088660	2 112,50 zł
6088670	G1-G3/4	4	150	240	PN 6 / 70°C	1	P-6085.60	7.001	6088670	2 172,90 zł
6088680	G1-G3/4	5	200	290	PN 6 / 70°C	1	P-6085.63	7.476	6088680	2 233,20 zł
6088690	G1-G3/4	6	250	340	PN 6 / 70°C	1	P-6085.63	7.951	6088690	2 293,80 zł
6088700	G1-G3/4	7	300	390	PN 6 / 70°C	1	P-6085.63	8.426	6088700	2 354,20 zł
6088710	G1-G3/4	8	350	440	PN 6 / 70°C	1	P-6085.66	8.900	6088710	2 414,50 zł
6088720	G1-G3/4	9	400	490	PN 6 / 70°C	1	P-6085.66	9.375	6088720	2 474,90 zł
6088730	G1-G3/4	10	450	540	PN 6 / 70°C	1	P-6085.66	9.850	6088730	2 535,30 zł
6088740	G1-G3/4	11	500	590	PN 6 / 70°C	1	P-6085.69	10.324	6088740	2 656,10 zł
6088750	G1-G3/4	12	550	640	PN 6 / 70°C	1	P-6085.69	10.797	6088750	2 776,90 zł

61. PROFF
Grupa pompowo-mieszająca PROFF

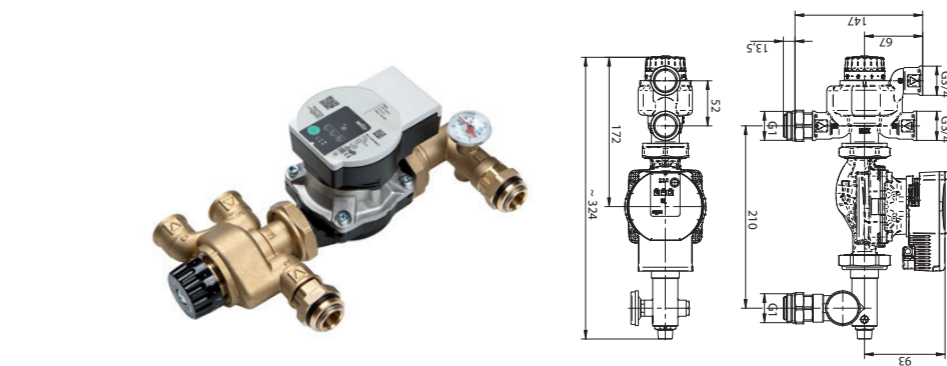

Kod	P nom.	Temp. nom.	mH ₂ O	Ilość szt.	Opakow.	Waga netto	Kod	Cena
6096700	PN 6	70°C	6	1	P-2449.98	3.884	6096700	1830,00 zł

62. BASE
Grupa mieszająca bez pompy

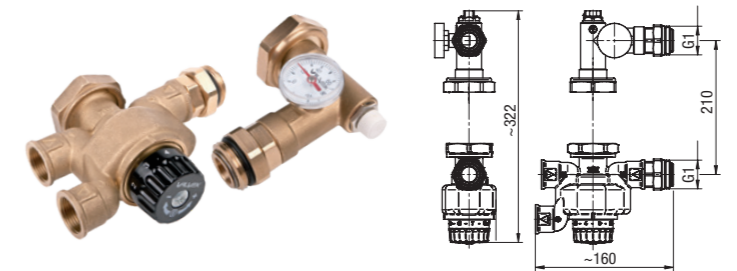

Kod	P nom.	Temp. nom.	Ilość szt.	Opakow.	Waga netto	Kod	Cena
6096720	PN 10	70°C	1	P-2449.98	2.116	6096720	840,00 zł

63. ONYX BASE
Zawór z pokrętkiem i uszczelnieniem EPDM do rozdzielaczy



Kod	P nom.	Temp. nom.	Ilość szt.	Opakow.	Waga netto	Kod	Cena
1454140	PN 10	95°C	4 / 24	P-1472.60/1 / P-1472.60/2	0,473	1454140	72,90 zł

64. PROFFmix
Grupa pompowa z zaworem
3-drogowym i siłownikiem

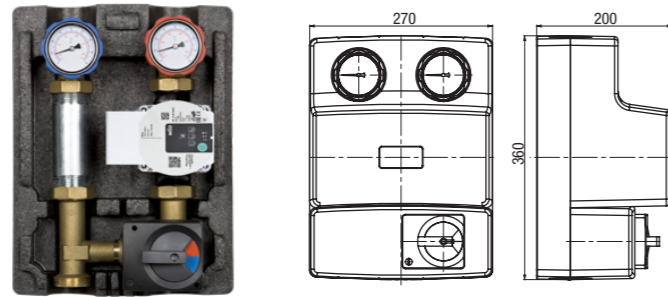

Kod	P nom.	Temp. nom.	mH ₂ O	Ilość szt.	Opakow.	Waga netto	Kod	Cena
6096800	PN 6	95°C	6	1	P-2449.98	6,642	6096800	2 240,00 zł

65. PROFFco
Grupa pompowa

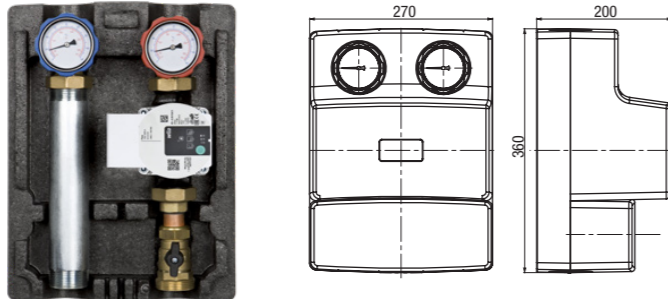

Kod	P nom.	Temp. nom.	mH ₂ O	Ilość szt.	Opakow.	Waga netto	Kod	Cena
6096820	PN 6	95°C	6	1	P-2449.98	5,954	6096820	1 623,00 zł

66. PROFFmix
Grupa pompowa PROFFmix
bez pompy

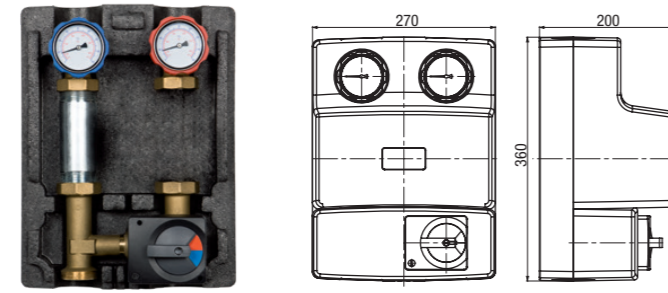

Kod	P nom.	Temp. nom.	Ilość szt.	Opakow.	Waga netto	Kod	Cena
6096870	PN 6	95°C	1	P-2449.98	4,794	6096870	1 513,00 zł

67. PROFFco
Grupa pompowa PROFFco
bez pompy

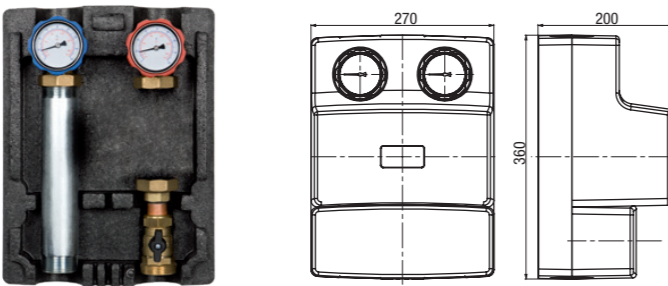

Kod	P nom.	Temp. nom.	Ilość szt.	Opakow.	Waga netto	Kod	Cena
6096880	PN 6	95°C	1	P-2449.98	3,962	6096880	818,00 zł

68. COMBI
Rozdzielacz kotłowy COMBI

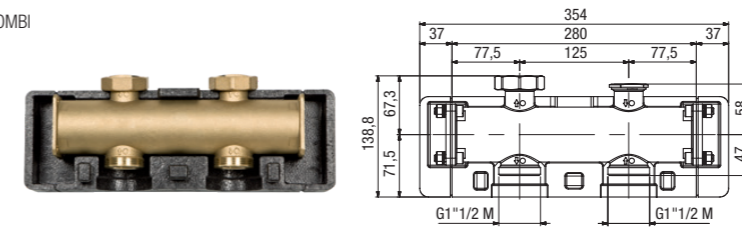

Kod	Ilość szt.	Opakow.	Waga netto	Kod	Cena
6096760	1	P-6096.76	3,069	6096760	593,00 zł

69. COMBI
Zaslepka do rozdzielacza kotłowego



Kod	Ilość szt.	Opakow.	Waga netto	Kod	Cena
6096770	20/1	P-1472.60/1 / woreczek foliowy	0,183	6096770	50,50 zł

70. CONTROLMIX3
Zawór mieszający 3-drogowy

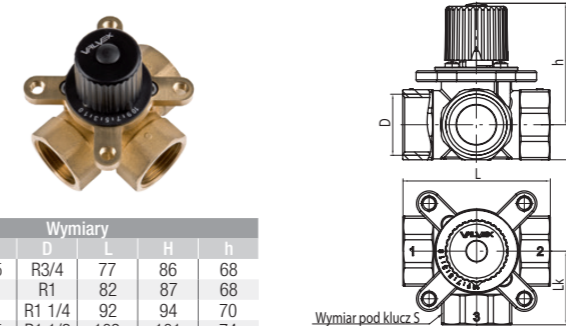

DN	Kod	Wymiary					
		S	Lk	D	L	H	h
20	6093100	31	38,5	R3/4	77	86	68
25	6094100	39	41	R1	82	87	68
32	6095100	49	46	R1 1/4	92	94	70
40	6096300	53	54,5	R1 1/2	109	101	74
50	6097470	68	59,5	R2	119	113	79

DN	Kod	P nom.	Temp. nom.	Kvs	Moment obrotu wrzeźciana	Rodzaje płynów	Ilość szt.	Opakow.	Waga netto	Kod	Cena
20	6093100	PN 10	-10°C ÷ 110°C	6,3 (m ³ /h)	<1 Nm	woda, glikol (≤50%)	1	P-6094.12	0,611	6093100	149,00 zł
25	6094100	PN 10	-10°C ÷ 110°C	12 (m ³ /h)	<1 Nm	woda, glikol (≤50%)	1	P-6094.12	0,752	6094100	162,40 zł
32	6095100	PN 10	-10°C ÷ 110°C	16 (m ³ /h)	<1 Nm	woda, glikol (≤50%)	1	P-6095.12	1,105	6095100	182,90 zł
40	6096300	PN 10	-10°C ÷ 110°C	25 (m ³ /h)	<1 Nm	woda, glikol (≤50%)	1	P-6095.12	1,105	6096300	353,60 zł
50	6097470	PN 10	-10°C ÷ 110°C	40 (m ³ /h)	<1 Nm	woda, glikol (≤50%)	1	P-6097.49	2,314	6097470	405,70 zł

71. CONTROLMIX4
Zawór mieszający 4-drogowy

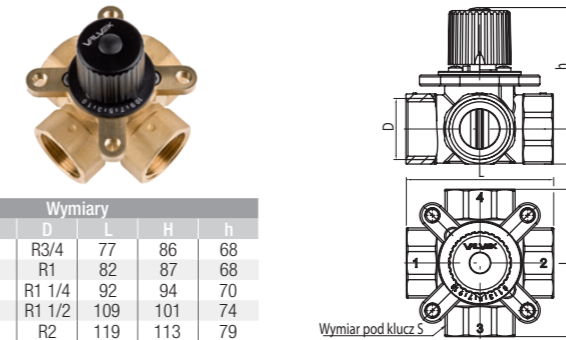

DN	Kod	Wymiary					
		S	Lk	D	L	H	h
20	6093120	31	-	R3/4	77	86	68
25	6094120	39	-	R1	82	87	68
32	6095120	49	-	R1 1/4	92	94	70
40	6096320	53	-	R1 1/2	109	101	74
50	6097490	68	-	R2	119	113	79

DN	Kod	P nom.	Temp. nom.	Kvs	Moment obrotu wrzeźciana	Rodzaje płynów	Ilość szt.	Opakow.	Waga netto	Kod	Cena
20	6093120	PN 10	-10°C ÷ 110°C	6,3 (m ³ /h)	<1 Nm	woda, glikol (≤50%)	1	P-6094.12	0,648	6093120	158,00 zł
25	6094120	PN 10	-10°C ÷ 110°C	12 (m ³ /h)	<1 Nm	woda, glikol (≤50%)	1	P-6094.12	0,870	6094120	171,10 zł
32	6095120	PN 10	-10°C ÷ 110°C	16 (m ³ /h)	<1 Nm	woda, glikol (≤50%)	1	P-6095.12	1,201	6095120	215,40 zł
40	6096320	PN 10	-10°C ÷ 110°C	25 (m ³ /h)	<1 Nm	woda, glikol (≤50%)	1	P-6095.12	1,201	6096320	468,30 zł
50	6097490	PN 10	-10°C ÷ 110°C	40 (m ³ /h)	<1 Nm	woda, glikol (≤50%)	1	P-6097.49	2,412	6097490	520,50 zł

72. V-MIX ST 10/230
Siłownik do zaworów



Kod	Kąt obrotu	Napięcie zasilania	Moment obrotowy	Czas otwarcia	Max temp. otoczenia	Ilość szt.	Opakow.	Waga netto	Kod	Cena
6098300	90°	230V / 50Hz	10 Nm	2 min.	50°C	1	P-6098.30	0,450	6098300	442,60 zł

73. V-MIX STM 10/230
Siłownik statotemperaturowy z czujnikiem przylgowym



Kod	Zakres temp.	Kąt obrotu	Napięcie zasilania	Moment obrotowy	Czas otwarcia	Max temp. otoczenia	Ilość szt.	Opakow.	Waga netto	Kod	Cena
6098320	20°C ÷ 80°C	90°	230V / 50Hz	10 Nm	2 min.	50°C	1	P-6098.30	0,501	6098320	984,60 zł

74. V-MIX ST 10/230
Zestaw: siłownik + zawór mieszający 3-drogowy



DN	Kod	P nom.	Temp. nom.	Kvs	Moment obrotowy	Rodzaje płynów	Ilość szt.	Waga netto	Opakow.	Kod	Cena
20	6093140	PN 10	-10°C ÷ 110°C	6,3 (m³/h)	10 Nm	woda, glikol (≤50%)	1	1,112	P-6094.16	6093140	557,40 zł
25	6094140	PN 10	-10°C ÷ 110°C	12 (m³/h)	10 Nm	woda, glikol (≤50%)	1	1,217	P-6094.16	6094140	574,70 zł
32	6095140	PN 10	-10°C ÷ 110°C	16 (m³/h)	10 Nm	woda, glikol (≤50%)	1	1,570	P-6095.16	6095140	594,10 zł
40	6096340	PN 10	-10°C ÷ 110°C	25 (m³/h)	10 Nm	woda, glikol (≤50%)	1	2,310	P-6095.16	6096340	636,20 zł
50	6097140	PN 10	-10°C ÷ 110°C	40 (m³/h)	10 Nm	woda, glikol (≤50%)	1	2,764	P-1	6097140	677,90 zł

75. V-MIX ST 10/230
Zestaw: siłownik + zawór mieszający 4-drogowy



DN	Kod	P nom.	Temp. nom.	Kvs	Moment obrotowy	Rodzaje płynów	Ilość szt.	Waga netto	Opakow.	Kod	Cena
20	6093160	PN 10	-10°C ÷ 110°C	6,3 (m³/h)	10 Nm	woda, glikol (≤50%)	1	1,157	P-6094.16	6093160	569,30 zł
25	6094160	PN 10	-10°C ÷ 110°C	12 (m³/h)	10 Nm	woda, glikol (≤50%)	1	1,256	P-6094.16	6094160	583,30 zł
32	6095160	PN 10	-10°C ÷ 110°C	16 (m³/h)	10 Nm	woda, glikol (≤50%)	1	1,666	P-6095.16	6095160	604,90 zł
40	6096350	PN 10	-10°C ÷ 110°C	25 (m³/h)	10 Nm	woda, glikol (≤50%)	1	2,260	P-6095.16	6096350	667,50 zł
50	6097130	PN 10	-10°C ÷ 110°C	40 (m³/h)	10 Nm	woda, glikol (≤50%)	1	2,862	P-1	6097130	698,80 zł

76. V-MIX STM 10/230
Zestaw: siłownik + zawór mieszający 3-drogowy



DN	Kod	P nom.	Temp. nom.	Kvs	Moment obrotowy siłownika	Rodzaje płynów	Ilość szt.	Waga netto	Opakow.	Kod	Cena
20	6093180	PN 10	-10°C ÷ 110°C	6,3 (m³/h)	10 Nm	woda, glikol (≤50%)	1	1,127	P-6094.16	6093180	1146,00 zł
25	6094180	PN 10	-10°C ÷ 110°C	12 (m³/h)	10 Nm	woda, glikol (≤50%)	1	1,267	P-6094.16	6094180	1156,80 zł
32	6095180	PN 10	-10°C ÷ 110°C	16 (m³/h)	10 Nm	woda, glikol (≤50%)	1	1,620	P-6095.16	6095180	1178,50 zł
40	6096360	PN 10	-10°C ÷ 110°C	25 (m³/h)	10 Nm	woda, glikol (≤50%)	1	2,203	P-6095.16	6096360	1272,50 zł
50	6097180	PN 10	-10°C ÷ 110°C	40 (m³/h)	10 Nm	woda, glikol (≤50%)	1	2,815	P-1	6097180	1293,30 zł

77. V-MIX STM 10/230
Zestaw: siłownik + zawór mieszający 4-drogowy



DN	Kod	P nom.	Temp. nom.	Kvs	Moment obrotowy siłownika	Rodzaje płynów	Ilość szt.	Waga netto	Opakow.	Kod	Cena
20	6093200	PN 10	-10°C ÷ 110°C	6,3 (m³/h)	10 Nm	woda, glikol (≤50%)	1	1,162	P-6094.16	6093200	1156,80 zł
25	6094200	PN 10	-10°C ÷ 110°C	12 (m³/h)	10 Nm	woda, glikol (≤50%)	1	1,338	P-6094.16	6094200	1167,60 zł
32	6095190	PN 10	-10°C ÷ 110°C	16 (m³/h)	10 Nm	woda, glikol (≤50%)	1	1,716	P-6095.16	6095190	1189,30 zł
40	6096370	PN 10	-10°C ÷ 110°C	25 (m³/h)	10 Nm	woda, glikol (≤50%)	1	2,310	P-6095.16	6096370	1146,30 zł
50	6097190	PN 10	-10°C ÷ 110°C	40 (m³/h)	10 Nm	woda, glikol (≤50%)	1	2,913	P-1	6097190	1314,20 zł

78. V-THERM
Sterownik do zaworów mieszających z czujnikiem pogodowym

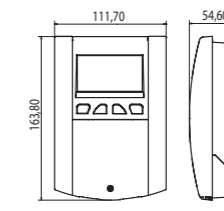

Kod	Zakres T (°C)	Napięcie zasilania	Pobór mocy	Ilość szt.	Opakow.	Waga netto	Kod	Cena
6098280	8-90	230V/50Hz +/- 10%	max. 4W	1	P-6098.20	0,443	6098280	490,80 zł

79. V-MIX ST 10/230
Zestaw: V-Therm + siłownik + zawór mieszający 3-drogowy



DN	Kod	P nom.	Temp. nom.	Kvs	Rodzaje płynów	Ilość szt.	Waga netto	Opakow.	Kod	Cena
20	6093220	PN 10	-10°C ÷ 110°C	6,3 (m³/h)	woda, glikol (≤50%)	1	1,520	P-6098.30	6093220	1081,10 zł
25	6094220	PN 10	-10°C ÷ 110°C	12 (m³/h)	woda, glikol (≤50%)	1	1,660	P-6098.30	6094220	1091,90 zł
32	6095280	PN 10	-10°C ÷ 110°C	16 (m³/h)	woda, glikol (≤50%)	1	2,012	P-110	6095280	1114,70 zł
40	6096380	PN 10	-10°C ÷ 110°C	25 (m³/h)	woda, glikol (≤50%)	1	2,595	P-110	6096380	1146,30 zł
50	6097220	PN 10	-10°C ÷ 110°C	40 (m³/h)	woda, glikol (≤50%)	1	3,207	P-110	6097220	1272,50 zł

80. V-MIX ST 10/230
Zestaw: V-Therm + siłownik + zawór mieszający 4-drogowy



DN	Kod	P nom.	Temp. nom.	Kvs	Rodzaje płynów	Ilość szt.	Waga netto	Opakow.	Kod	Cena
20	6093240	PN 10	-10°C ÷ 110°C	6,3 (m³/h)	woda, glikol (≤50%)	1	1,555	P-6098.30	6093240	1091,90 zł
25	6094240	PN 10	-10°C ÷ 110°C	12 (m³/h)	woda, glikol (≤50%)	1	1,731	P-6098.30	6094240	1102,80 zł
32	6095290	PN 10	-10°C ÷ 110°C	16 (m³/h)	woda, glikol (≤50%)	1	2,108	P-110	6095290	1141,70 zł
40	6096390	PN 10	-10°C ÷ 110°C	25 (m³/h)	woda, glikol (≤50%)	1	2,703	P-110	6096390	1168,20 zł
50	6097240	PN 10	-10°C ÷ 110°C	40 (m³/h)	woda, glikol (≤50%)	1	3,305	P-110	6097240	1293,30 zł

83. FEST
Zawór odcinający do rozdzielaczy G 1/2

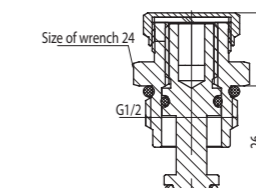

Kod	Wymiar	P nom. / max temp.	Ilość szt.	Opakow.	Waga netto	Kod	Cena
6097150	G1/2	PN 10, 100°C	50/10	P-38 / P-2406	0,086	6097150	11,90 zł

ARMATURA INSTALACYJNA CENTRALNEGO OGRZEWANIA

ARMATURA INSTALACYJNA CENTRALNEGO OGRZEWANIA

84. SECURE

Grupa bezpieczeństwa rozdzielacza

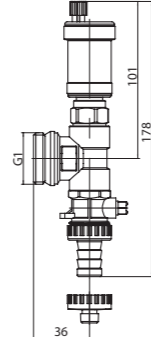

GUARANTEE
10
YEARS
LIMITED

Kod	Wymiar	P nom. / max temp.	Ilość szt.	Opakow.	Waga netto	Kod	Cena
6097400	1x1/2x1/2	PN 10, 100°C	18/1	P-38 / P-2406	0,366	6097400	70,30 zł

85. BASE

Głowica termoelektryczna

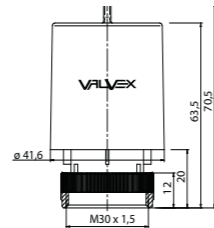

GUARANTEE
2
YEARS
LIMITED

Kod	Zasilanie	Przyłącze	Ilość szt.	Opakow.	Waga netto	Kod	Cena
6098120	230 V	M30 x 1,5	18/1	P-42 / P-6098.12	0,220	6098120	59,00 zł

85. DIRECT

Zawór termostatyczny do rozdzielaczy do manualnego sterowania

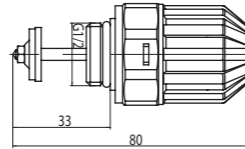

GUARANTEE
2
YEARS
LIMITED

Kod	Wymiar	P nom. / max temp.	Ilość szt.	Opakow.	Waga netto	Kod	Cena
6097200	G1/2	PN 10, 100°C	25/1	P-38 / P-2406	0,101	6097200	15,70 zł

86. MINI

Zawór MINI z dławikiem czerwony, z oringiem i złączką PEX/AL 16x2

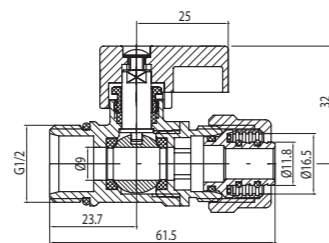

GUARANTEE
25
YEARS
LIMITED

Kod	Wymiar	P nom. / max temp.	Ilość szt.	Opakow.	Waga netto	Kod	Cena
6097360	1/2"	PN 10, 65°C	30/1	P-43 / bag	0,137	6097360	22,60 zł

87. MINI

Zawór MINI z dławikiem niebieski, z oringiem i złączką PEX/AL 16x2

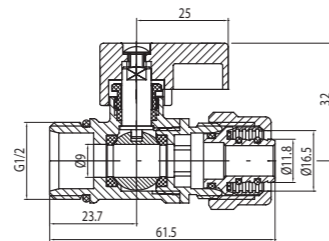

GUARANTEE
25
YEARS
LIMITED

Kod	Wymiar	P nom. / max temp.	Ilość szt.	Opakow.	Waga netto	Kod	Cena
6097350	1/2"	PN 10, 65°C	30/1	P-43 / bag	0,137	6097350	22,60 zł

88. MINI PLUS

Zawór MINI PLUS czerwony, z systemem doszczelnienia i złączką PEX/AL G1/2x16

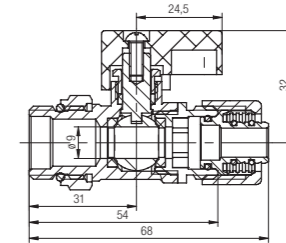

GUARANTEE
25
YEARS
LIMITED

Kod	Wymiar	P nom. / max temp.	Ilość szt.	Opakow.	Waga netto	Kod	Cena
6097390	1/2"	PN 10, 65°C	90/15/1	P-43 / bag	0,165	6097390	22,70 zł

89. MINI PLUS

Zawór MINI PLUS niebieski, z systemem doszczelnienia i złączką PEX/AL G1/2x16

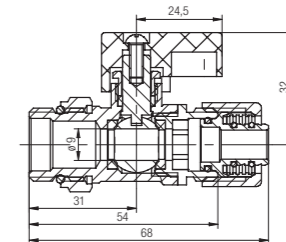

GUARANTEE
25
YEARS
LIMITED

Kod	Wymiar	P nom. / max temp.	Ilość szt.	Opakow.	Waga netto	Kod	Cena
6097380	1/2"	PN 10, 65°C	90/15/1	P-43 / bag	0,165	6097380	22,70 zł

90. VISION

Przepływomierz do rozdzielaczy

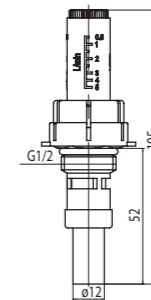

GUARANTEE
2
YEARS
LIMITED

Kod	Wymiar	P nom. / max temp.	Ilość szt.	Opakow.	Waga netto	Kod	Cena
6097250	G1/2	PN 6 / 70°C	30/5	P-1	0,057	6097250	37,40 zł

91. BASE

Wspornik stalowy do rozdzielaczy

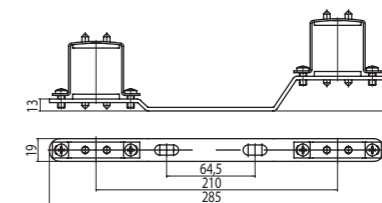

GUARANTEE
2
YEARS
LIMITED

Kod	Ilość szt.	Opakow.	Waga netto	Kod	Cena
6097500	40/2	P-25 / woreczek foliowy	0,159	6097500	35,80 zł

92. PROFF

Wspornik stalowy do rozdzielaczy

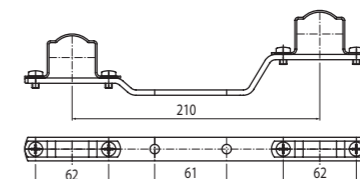

GUARANTEE
2
YEARS
LIMITED

Kod	Ilość szt.	Opakow.	Waga netto	Kod	Cena
6090140	40/2	P-25 / woreczek foliowy	0,252	6090140	34,10 zł

93. COPPER

Przyłączka 15Cu-G3/4/18 niklowana

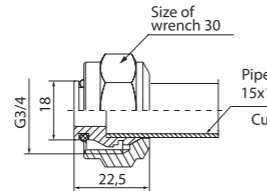

Kod	Wymiar	P nom. / max temp.	Ilość szt.	Opakow.	Waga netto	Kod	Cena
9003990	15Cu-G3/4	PN 10 / 90°C	135/15	P-1 / 22x25 woreczek foliowy	0,065	9003990	11,30 zł

94. PEX

Przyłączka G3/4 niklowana (do rur PEX)

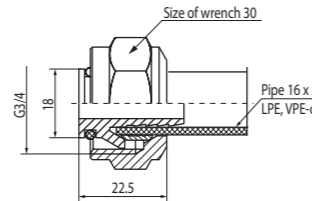

Kod	Wymiar	P nom. / max temp.	Ilość szt.	Opakow.	Waga netto	Kod	Cena
9006570	3/4"	PN 10 / 90°C	120/15	P-1 / woreczek foliowy	0,076	9006570	17,30 zł

95. PEX-AL

Przyłączka prosta 16x2-G3/4 niklowana

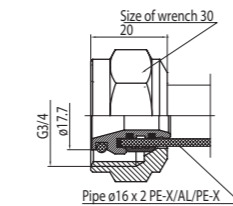

Kod	Wymiar	P nom. / max temp.	Ilość szt.	Opakow.	Waga netto	Kod	Cena
6008430	16x2-G3/4"	PN 10 / 90°C	90/15	P-1 / woreczek foliowy	0,065	6008430	14,60 zł
6008500	16x2-G3/4"	PN 10 / 90°C	2	woreczek foliowy	0,065	6008500	14,80 zł

96. PEX/AL

Nypel do rozdzielaczy ze złączką PEX-AL G1/2x16 standardowy

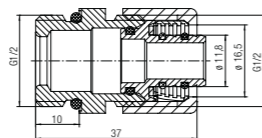

Kod	Wymiar	P nom. / max temp.	Ilość szt.	Opakow.	Waga netto	Kod	Cena
6007350	1/2"	PN 10 / 90°C	150/25/1	woreczek foliowy	0,075	6007350	10,90 zł

97. PEX-AL

Nypel do rozdzielaczy ze złączką PEX-AL G1/2x16 do rotametrów

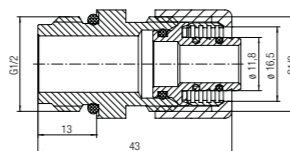

Kod	Wymiar	P nom. / max temp.	Ilość szt.	Opakow.	Waga netto	Kod	Cena
6007370	1/2"	PN 10 / 90°C	150/25/1	woreczek foliowy	0,087	6007370	12,80 zł

98. VISION

Złączka redukcyjna z oringiem G1/2-3/4 do przepływomierzy

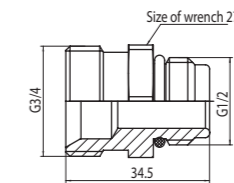

Kod	Wymiar	P nom.	Ilość szt.	Opakow.	Waga netto	Kod	Cena
6097100	1/2"-3/4"	PN 10	80/10	P-1 / P-14	0,075	6097100	8,10 zł

99. MICRA

Złączka wkrętna redukcyjna z oringiem 1/2"-3/4"-18 śrutowana

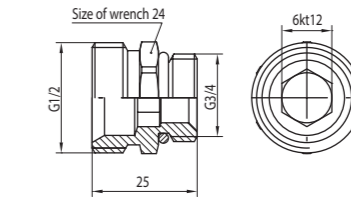

Kod	Wymiar	P nom.	Ilość szt.	Opakow.	Waga netto	Kod	Cena
6096220	1/2"-3/4"	PN 10	80/10	P-43 / 15x25 woreczek foliowy	0,046	6096220	7,60 zł

100. Kerek kolektora śrutowany

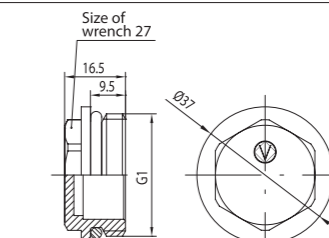

Kod	Wymiar	P nom. / max temp.	Ilość szt.	Opakow.	Waga netto	Kod	Cena
6096100	1"	PN 10 / 95°C	60/10	P-43 / 15x25 woreczek foliowy	0,051	6096100	8,60 zł

101. AXE

Złączka nakrętno-wkrętna redukcyjna G1-G3/4 do rury kolektora

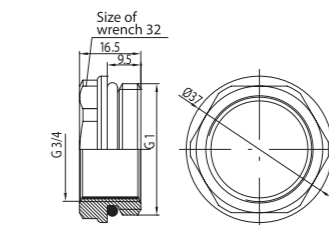

Kod	Wymiar	P nom. / max temp.	Ilość szt.	Opakow.	Waga netto	Kod	Cena
6096140	1"-3/4"	PN 10 / 95°C	60/10	P-43 / 15x25 woreczek foliowy	0,037	6096140	7,90 zł

102. VIRGO

Obejma ZT22 do głowicy GZ03 (zabezpieczenie głowicy przed demontażem)

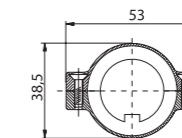

Kod	Wymiary		Ilość szt.	Opakow.	Waga netto	Kod	Cena
	A	L					
4413450	38,5	53	100	P-1	0,014	4413450	2,70 zł

103. VECTOR

Klucz do nastaw ZT22

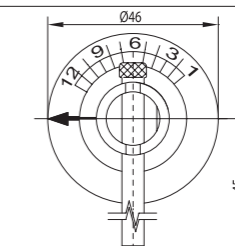

Kod	Ilość szt.	Opakow.	Waga netto	Kod	Cena
4412450	60	P-1	0,076	4412450	28,40 zł

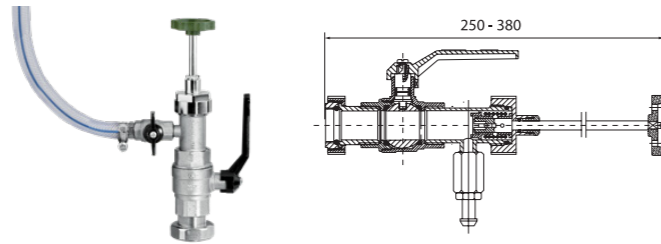
104. VECTOR
Demoblok

GUARANTEE
25
YEARS
LIMITED

Kod	Ilość szt.	Waga netto	Kod	Cena
4411400	1	1,406	4411400	559,80 zł

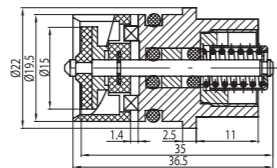
105. VECTOR
Wkład ZT22 do zaworu termostatycznego

GUARANTEE
2
YEARS
LIMITED

Kod	Ilość szt.	Opakow.	Waga netto	Kod	Cena
4412400	200	P-1	0,045	4412400	30,60 zł

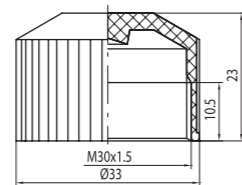
106. PROTECTIVE CAP
Kolpak ochronny

GUARANTEE
2
YEARS
LIMITED

Kod	Ilość szt.	Opakow.	Waga netto	Kod	Cena
4412130	150	P-1	0,004	4412130	2,80 zł

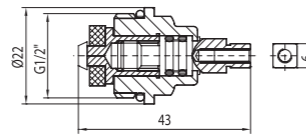
107. ACTIV
Głowica do zaworów grzejnikowych PS i KS

GUARANTEE
2
YEARS
LIMITED

Kod	Wymiar	Ilość szt.	Opakow.	Waga netto	Kod	Cena
4482170	G1/2-14	200/20	P-1 / 22x25 woreczek foliowy	0,051	4482170	9,70 zł

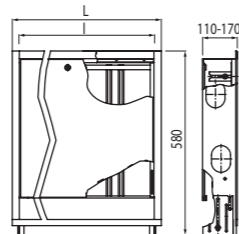
108. VELA
Szafka podtynkowa

GUARANTEE
2
YEARS
LIMITED

Kod	Wymiary				Ilość szt.	Waga netto	Kod	Cena
	Wersja	L	I	Ilość szt.				
6091600	SP-0	380	335	2-4	1	5,900	6091600	256,00 zł
6091610	SP-1	480	435	5-6	1	7,600	6091610	282,10 zł
6091620	SP-2	610	565	7-8	1	8,700	6091620	307,20 zł
6091630	SP-3	760	715	9-10	1	10,000	6091630	346,30 zł
6091640	SP-4	840	795	11-12	1	11,100	6091640	380,10 zł
6091650	SP-5	1010	965	13-14	1	13,000	6091650	399,10 zł

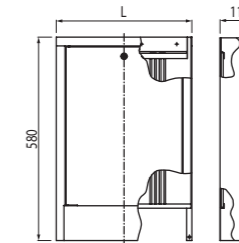
109. VELA
Szafka natynkowa

GUARANTEE
2
YEARS
LIMITED

Kod	Wymiary			Ilość szt.	Waga netto	Kod	Cena
	Wersja	L	Ilość szt.				
6091700	SN-0	385	2-4	1	4,700	6091700	276,00 zł
6091710	SN-1	485	5-6	1	5,200	6091710	316,20 zł
6091720	SN-2	615	7-8	1	6,800	6091720	333,00 zł
6091730	SN-3	760	9-10	1	8,000	6091730	358,30 zł
6091740	SN-4	845	11-12	1	9,100	6091740	378,80 zł
6091750	SN-5	1015	13-14	1	10,700	6091750	410,70 zł

1. TWIST

Złączka prosta śrutowana (wersja długa), śrubunek

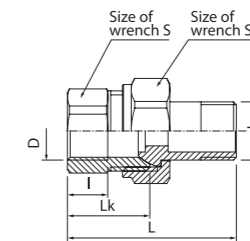

DN	Kod	Wymiary										P nom. / max temp.	Ilość szt.	Opakow.	Waga netto	Kod	Cena
		Rozmiar	D	d	L	Lk	I	S	S1								
10	4911010	3/8"	Rp3/8	R3/8	50	24	11	22	27	PN 10 / 100°C	50	P-43	0,102	4911010	12,30 zł		
15	4912010	1/2"	Rp1/2	R1/2	54	26	12	26	30	PN 10 / 100°C	50	P-43	0,124	4912010	16,80 zł		
20	4913010	3/4"	Rp3/4	R3/4	60	28	14	32	38	PN 10 / 100°C	50	P-1	0,189	4913010	25,40 zł		
25	4914010	1"	Rp1	R1	65	30	16	40	46	PN 10 / 100°C	50	P-1	0,303	4914010	37,90 zł		

2. TWIST

Złączka prosta niklowana (wersja długa), śrubunek

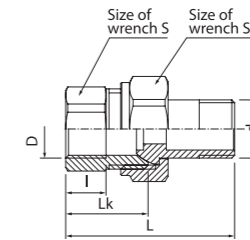

DN	Kod	Wymiary										P nom. / max temp.	Ilość szt.	Opakow.	Waga netto	Kod	Cena
		Rozmiar	D	d	L	Lk	I	S	S1								
15	4912020	1/2"	Rp1/2	R1/2	54	26	12	26	30	PN 10 / 100°C	50	P-43	0,124	4912020	16,80 zł		
20	4913020	3/4"	Rp3/4	R3/4	60	28	14	32	38	PN 10 / 100°C	50	P-1	0,189	4913020	22,70 zł		

3. TWIST

Złączka prosta śrutowana z oringiem (wersja długa), śrubunek

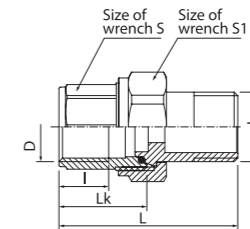

DN	Kod	Wymiary										P nom. / max temp.	Ilość szt.	Opakow.	Waga netto	Kod	Cena
		Rozmiar	D	d	L	Lk	I	S	S1								
15	4912030	1/2"	Rp1/2	R1/2	54	26	12	24	30	PN 10 / 100°C	50	P-43	0,103	4912030	16,80 zł		
20	4913030	3/4"	Rp3/4	R3/4	60	28	14	30	37	PN 10 / 100°C	50	P-1	0,162	4913030	25,00 zł		
25	4914030	1"	Rp1	R1	65	30	16	38	46	PN 10 / 100°C	30	P-1	0,267	4914030	34,90 zł		

4. TWIST

Złączka prosta niklowana z oringiem (wersja długa), śrubunek

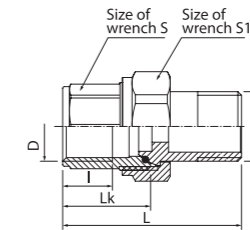

DN	Kod	Wymiary										P nom. / max temp.	Ilość szt.	Opakow.	Waga netto	Kod	Cena
		Rozmiar	D	d	L	Lk	I	S	S1								
15	4912040	1/2"	Rp1/2	R1/2	54	26	12	24	30	PN 10 / 100°C	50	P-43	0,106	4912040	18,10 zł		
20	4913040	3/4"	Rp3/4	R3/4	60	28	14	30	37	PN 10 / 100°C	50	P-1	0,162	4913040	27,00 zł		

5. TWIST

Złączka prosta śrutowana (wersja krótka), śrubunek

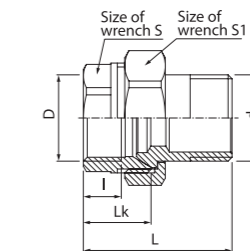

DN	Kod	Wymiary										P nom. / max temp.	Ilość szt.	Opakow.	Waga netto	Kod	Cena
		Rozmiar	D	d	L	Lk	I	S	S1								
15	4912500	1/2"	Rp1/2	R1/2	48	17	12	24	30	PN 10 / 100°C	50	P-43	0,088	4912500	14,20 zł		
20	4913500	3/4"	Rp3/4	R3/4	52	21	15	34	37	PN 10 / 100°C	70	P-1	0,134	4913500	21,10 zł		
25	4914500	1"	Rp1	R1	61	24	17	42	46	PN 10 / 100°C	30/5	P-1 / foil bag	0,270	4914500	42,30 zł		
32	4915500	1 1/4"	Rp1 1/4	R1 1/4	65,5	25,5	17	47	54	PN 10 / 100°C	20/5	P-1 / foil bag	0,409	4915500	65,10 zł		
40	4916500	1 1/2"	Rp1 1/2	R1 1/2	67	27	19	58	65	PN 10 / 100°C	15/5	P-1 / foil bag	0,577	4916500	93,60 zł		
50	4917500	2"	Rp2	R2	77	31	22	70	76	PN 10 / 100°C	8	P-1 / foil bag	1,027	4917500	180,80 zł		

6. TWIST
Złączka prosta śrutowana
z oringiem (wersja krótka), śrubunek

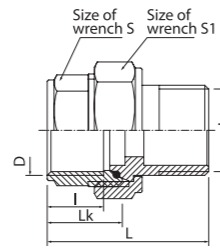

DN	Kod	Rozmiar	Wymiary								P nom. / max temp.	Ilość szt.	Opakow.	Waga netto	Kod	Cena
			D	d	L	Lk	I	S	S1							
15	4912050	1/2"	Rp1/2	R1/2	43	19	12	24	30	PN 10 / 100°C	50	P-43	0,085	4912050	13,10 zł	
20	9024040	3/4"	Rp3/4	R3/4	49	22	14	32	38	PN 10 / 100°C	60	P-1	0,166	9024040	19,40 zł	
25	9024060	1"	Rp1	R1	54	24	16	40	46	PN 10 / 100°C	30	P-1	0,273	9024060	34,30 zł	
32	9024080	1 1/4"	Rp1 1/4	R1 1/4	65.5	30	23	52	56	PN 10 / 100°C	24	P-1	0,388	9024080	70,10 zł	
40	9024100	1 1/2"	Rp1 1/2	R1 1/2	67	31	23	58	64	PN 10 / 100°C	15	P-1	0,615	9024100	93,80 zł	
50	9024120	2"	Rp2	R2	77	36.5	27.5	70	76	PN 10 / 100°C	6	P-1	1,131	9024120	195,40 zł	

7. TWIST
Złączka kolankowa
śrutowana, śrubunek

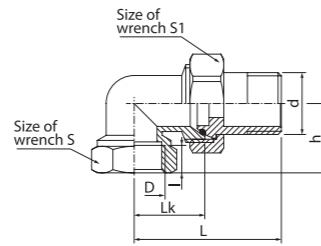

DN	Kod	Rozmiar	Wymiary								P nom. / max temp.	Ilość szt.	Opakow.	Waga netto	Kod	Cena
			D	d	L	Lk	I	H	S	S1						
10	4916010	3/8"	Rp3/8	R3/8	52	26	10	25	22	PN 10 / 100°C	50	P-43	0,119	4916010	18,00 zł	
15	4917010	1/2"	Rp1/2	R1/2	56.5	29.5	15	33	27	PN 10 / 100°C	30	P-43	0,165	4917010	24,40 zł	
20	4918010	3/4"	Rp3/4	R3/4	61	32.5	16.5	37	30	PN 10 / 100°C	30	P-1	0,251	4918010	37,10 zł	
25	4919010	1"	Rp1	R1	69.5	36.5	19.5	46.5	37	PN 10 / 100°C	20	P-1	0,400	4919010	56,50 zł	

8. TWIST
Złączka kolankowa śrutowana
z oringiem, śrubunek

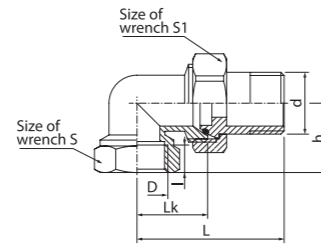

DN	Kod	Rozmiar	Wymiary								P nom. / max temp.	Ilość szt.	Opakow.	Waga netto	Kod	Cena
			D	d	L	Lk	I	H	S	S1						
15	4917030	1/2"	Rp1/2	R3/8	60	31	12	28	25	PN 10 / 100°C	30	P-43	0,131	4917030	21,30 zł	
20	4918030	3/4"	Rp3/4	R3/4	66	34	14	30	32	PN 10 / 100°C	40	P-1	0,215	4918030	30,40 zł	
25	4919030	1"	Rp1	R1	72	37	16	35	38	PN 10 / 100°C	20	P-1	0,331	4919030	48,20 zł	
32	9024200	1 1/4"	Rp1 1/4	R1 1/4	79	44	21.5	51	47	PN 10 / 100°C	15	P-1	0,511	9024200	75,80 zł	
40	9024220	1 1/2"	Rp1 1/2	G1 1/2	86	50	21.5	56.5	54	PN 10 / 100°C	8	P-1	0,882	9024220	129,60 zł	
50	9024240	2"	Rp2	R2	103	63	25.5	69	66	PN 10 / 100°C	4	P-1	1,717	9024240	271,70 zł	

9. TWIST
Przedłużacz śrutowany 15M

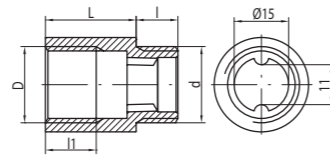

DN	Kod	Version	Wymiary						P nom. / max temp.	Ilość szt.	Opakow.	Waga netto	Kod	Cena
			D	d	L	I	I1	I2						
15	0200160	15M-L10	G1/2	G1/2	10	10	8.5	PN 10 / 100°C	100/10	P-43/foil bag	0,028	0200160	3,90 zł	
15	0200120	15M-L15	G1/2	G1/2	15	11.5	10.5	PN 10 / 100°C	100	P-43	0,041	0200120	5,30 zł	
15	0200110	15M-L20	G1/2	G1/2	20	11.5	14	PN 10 / 100°C	100	P-43	0,054	0200110	6,50 zł	
15	0200100	15M-L25	G1/2	G1/2	25	11.5	14	PN 10 / 100°C	90	P-43	0,065	0200100	7,50 zł	
15	0200090	15M-L30	G1/2	G1/2	30	11.5	14	PN 10 / 100°C	70	P-43	0,054	0200090	9,10 zł	
15	0200080	15M-L35	G1/2	G1/2	35	11.5	14	PN 10 / 100°C	60	P-43	0,098	0200080	9,90 zł	
15	0200070	15M-L40	G1/2	G1/2	40	11.5	14	PN 10 / 100°C	60	P-43	0,112	0200070	10,80 zł	
15	0200060	15M-L50	G1/2	G1/2	50	11.5	14	PN 10 / 100°C	50	P-43	0,140	0200060	13,10 zł	
15	0200050	15M-L60	G1/2	G1/2	60	11.5	14	PN 10 / 100°C	40	P-43	0,160	0200050	14,20 zł	

10. TWIST
Przedłużacz śrutowany 20M

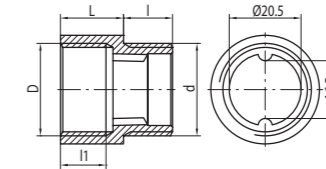

DN	Kod	Version	Wymiary						P nom. / max temp.	Ilość szt.	Opakow.	Waga netto	Kod	Cena
			D	d	L	I	I1	I2						
20	0200130	20M-L20	G3/4	G3/4	20	12	15	PN 10 / 100°C	70/10	P-43 / foil bag	0,061	0200130	8,30 zł	

11. TWIST
Kolanko nakrętno śrutowane

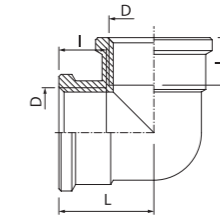

Kod	Rozmiar	Wymiary				P nom. / max temp.	Ilość szt.	Opakow.	Waga netto	Kod	Cena
		D	d	L	I						
6041380	3/8"	G3/8	G3/8	22.5	10	PN 10 / 100°C	100/10	P-43 / foil bag	0,035	6041380	5,80 zł
6042380	1/2"	G1/2	G1/2	25	12	PN 10 / 100°C	50	P-43	0,079	6042380	10,50 zł
6043380	3/4"	G3/4	G3/4	27.5	13.5	PN 10 / 100°C	30	P-43	0,123	6043380	15,20 zł
6044380	1"	G1	G1	33	16	PN 10 / 100°C	30	P-1	0,216	6044380	25,20 zł
6045380	1 1/4"	G1 1/4	G1 1/4	41.5	18.5	PN 10 / 100°C	25/5	P-1 / foil bag	0,201	6045380	34,90 zł

12. TWIST
Kolanko nakrętno-wkrętne śrutowane

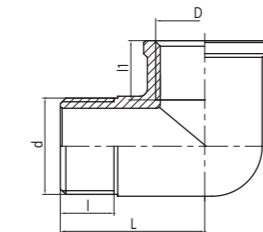

Kod	Rozmiar	Wymiary						P nom. / max temp.	Ilość szt.	Opakow.	Waga netto	Kod	Cena
		D	d	L	I	I1	H						
6041100	3/8"	G3/8	G3/8	27	10.5	10.5	18	PN 10 / 100°C	100/10	P-43 / foil bag	0,035	6041100	5,80 zł
6042100	1/2"	G1/2	G1/2	33	13	14	24	PN 10 / 100°C	60/10	P-43 / foil bag	0,078	6042100	10,60 zł
6043100	3/4"	G3/4	G3/4	39	14.5	16	28.5	PN 10 / 100°C	60/10	P-43 / foil bag	0,123	6043100	15,30 zł
6044100	1"	G1	G1	44	17	18	33	PN 10 / 100°C	40/5	P-43 / foil bag	0,197	6044100	25,80 zł

13. TWIST
Trójnik nakrętny śrutowany

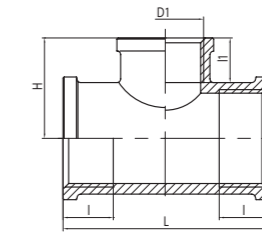

Kod	Rozmiar	Wymiary				P nom. / max temp.	Ilość szt.	Opakow.	Waga netto	Kod	Cena
		D	H	L	I						
6051420	3/8"	G3/8	22.5	45	10	PN 10 / 100°C	70/10	P-43 / foil bag	0,043	6051420	7,50 zł
6052420	1/2"	G1/2	23.5	47	12	PN 10 / 100°C	40	P-43	0,104	6052420	12,10 zł
6053420	3/4"	G3/4	27.5	55	13.5	PN 10 / 100°C	25	P-43	0,168	6053420	19,90 zł
6054420	1"	G1	32	64	15	PN 10 / 100°C	30	P-1	0,276	6054420	32,00 zł

14. TWIST
Trójnik nakrętny niklowany

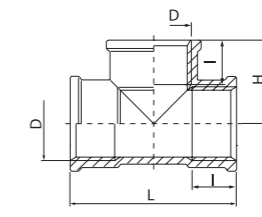

Kod	Rozmiar	Wymiary				P nom. / max temp.	Ilość szt.	Opakow.	Waga netto	Kod	Cena
		D	H	L	I						
6052430	1/2"	G1/2	23.5	47	12	PN 10 / 100°C	40	P-43	0,104	6052430	13,90 zł
6053430	3/4"	G3/4	27.5	55	13.5	PN 10 / 100°C	25	P-43	0,168	6053430	20,40 zł
6054430	1"	G1	32	64	15	PN 10 / 100°C	30	P-1	0,276	6054430	30,40 zł

SYSTEMY INSTALACYJNE
- ZŁĄCZKI DO RUR STALOWYCH

SYSTEMY INSTALACYJNE
- ZŁĄCZKI DO RUR STALOWYCH

15. TWIST
Trójnik nakrętny śrutowany

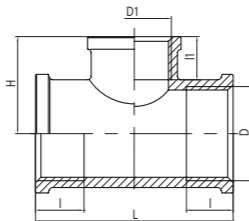

Kod	Version	Wymiary						P nom. / max temp.	Ilość szt.	Opakow.	Waga netto	Kod	Cena
		D	D1	L	L1	H	H						
6052100	3/4"-1/2"-3/4"	G3/4	G1/2	55	13.5	12	27	PN 10 / 100°C	20/10	P-43 / foil bag	0,099	6052100	15,90 zł
6053100	1"-1/2"-1"	G1	G1/2	55	15	12	32	PN 10 / 100°C	15/5	P-43 / foil bag	0,127	6053100	22,50 zł
6054100	1"-3/4"-1"	G1	G3/4	56	15	13.5	32	PN 10 / 100°C	15/5	P-43 / foil bag	0,140	6054100	24,90 zł

16. TWIST
Złączka nakrętna śrutowana - mufa

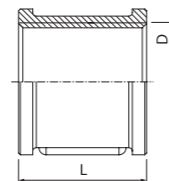

Kod	Rozmiar	Wymiary		P nom. / max temp.	Ilość szt.	Opakow.	Waga netto	Kod	Cena
		D	L						
6031100	3/8"	G3/8	24	PN 10 / 100°C	100/10	P-43 / foil bag	0,027	6031100	4,80 zł
6032100	1/2"	G1/2	27	PN 10 / 100°C	70/10	P-43 / foil bag	0,046	6032100	6,80 zł
6033100	3/4"	G3/4	30	PN 10 / 100°C	40/10	P-43 / foil bag	0,067	6033100	9,90 zł
6034100	1"	G1	33	PN 10 / 100°C	30/10	P-43 / foil bag	0,095	6034100	13,90 zł
6035100	1 1/4"	G1 1/4	38	PN 10 / 100°C	10/5	P-43 / foil bag	0,142	6035100	23,40 zł

17. TWIST
Złączka nakrętna redukcyjna śrutowana

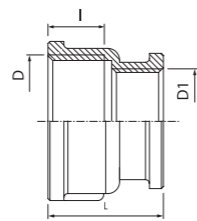

Kod	Version	Wymiary						P nom. / max temp.	Ilość szt.	Opakow.	Waga netto	Kod	Cena
		D	D1	L	L1	S	S						
6031030	1/2"-3/8"	G1/2	G3/8	27	14	100/10	PN 10 / 100°C	100/10	P-43 / foil bag	0,029	6031030	5,30 zł	
6032030	3/4"-1/2"	G3/4	G1/2	27.5	14.5	PN 10 / 100°C	60/10	P-43 / foil bag	0,056	6032030	8,60 zł		
6033030	1"-1/2"	G1	G1/2	31	16.5	PN 10 / 100°C	60/5	P-43 / foil bag	0,068	6033030	11,30 zł		
6034030	1"-3/4"	G1	G3/4	32	16.5	PN 10 / 100°C	40/5	P-43 / foil bag	0,071	6034030	11,40 zł		

18. TWIST
Złączka wkrętna śrutowana - nypel

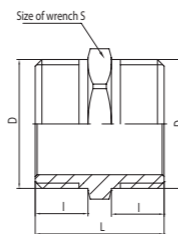

Kod	Rozmiar	Wymiary						P nom. / max temp.	Ilość szt.	Opakow.	Waga netto	Kod	Cena
		d	L	L	S	S	S						
6031150	3/8"	G3/8	22.5	9	17	PN 10 / 100°C	250/10	P-43 / foil bag	0,020	6031150	3,20 zł		
6032150	1/2"	G1/2	26.5	10.5	21	PN 10 / 100°C	130/10	P-43 / foil bag	0,031	6032150	5,00 zł		
6033150	3/4"	G3/4	29	11.5	27	PN 10 / 100°C	70/10	P-43 / foil bag	0,043	6033150	7,10 zł		
6034150	1"	G1	33	13.5	34	PN 10 / 100°C	40/5	P-43 / foil bag	0,067	6034150	11,50 zł		
6035150	1 1/4"	G1 1/4	36	14.5	43	PN 10 / 100°C	50/5	P-1 / foil bag	0,103	6035150	18,50 zł		
6036150	1 1/2"	G1 1/2	41	16.5	49	PN 10 / 100°C	40/5	P-1 / foil bag	0,140	6036150	24,80 zł		

19. TWIST
Złączka wkrętna redukcyjna śrutowana

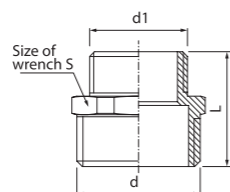

Kod	Version	Wymiary						P nom. / max temp.	Ilość szt.	Opakow.	Waga netto	Kod	Cena
		d	d1	L	S	S	S						
6031060	1/2"-3/8"	G1/2	G3/8	26	21	PN 10 / 100°C	150/10	P-43 / foil bag	0,024	6031060	4,30 zł		
6032060	1/2"-3/4"	G3/4	G1/2	28.5	27	PN 10 / 100°C	80/10	P-43 / foil bag	0,038	6032060	6,90 zł		
6033060	1/2"-1"	G1	G1/2	33	34	PN 10 / 100°C	100/5	P-1 / foil bag	0,055	6033060	10,70 zł		
6034060	3/4"-1"	G1	G3/4	34	34	PN 10 / 100°C	100/5	P-1 / foil bag	0,061	6034060	11,20 zł		

20. TWIST
Złączka nakrętno-wkrętna redukcyjna śrutowana

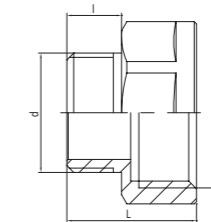

Kod	Version	Wymiary						P nom. / max temp.	Ilość szt.	Opakow.	Waga netto	Kod	Cena
		D	d	L	L	S	S						
6031010	3/8"-1/2"	G1/2	G3/8	25.5	10.5	24	PN 10 / 100°C	120/10	P-43 / foil bag	0,033	6031010	5,10 zł	
6032010	1/2"-3/8"	G3/8	G1/2	21.5	12	21	PN 10 / 100°C	150/10	P-43 / foil bag	0,027	6032010	4,80 zł	
6033010	1/2"-3/4"	G3/4	G1/2	24.5	10.5	30	PN 10 / 100°C	80/10	P-43 / foil bag	0,051	6033010	8,30 zł	
6035010	3/4"-1/2"	G1/2	G3/4	25	13	27	PN 10 / 100°C	80/10	P-43 / foil bag	0,041	6035010	7,10 zł	
6036010	3/4"-1"	G1	G3/4	28.5	12	36	PN 10 / 100°C	40/10	P-43 / foil bag	0,080	6036010	12,80 zł	
6037010	1"-3/4"	G3/4	G1	27	14	34	PN 10 / 100°C	40/5	P-43 / foil bag	0,075	6037010	12,60 zł	

21. TWIST
Złączka nakrętno-wkrętna redukcyjna śrutowana

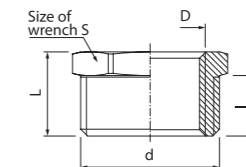

Kod	Version	Wymiary						P nom. / max temp.	Ilość szt.	Opakow.	Waga netto	Kod	Cena
		D	d	L	L	S	S						
6032500	3/8"-1/2"	G3/8	G1/2	17	12	21	PN 10 / 100°C	200/10	P-43 / foil bag	0,014	6032500	2,80 zł	
6033500	1/2"-3/4"	G1/2	G3/4	18	12.5	27	PN 10 / 100°C	150/10	P-43 / foil bag	0,026	6033500	4,90 zł	
6034500	1/2"-1"	G1/2	G1	21.5	15	34	PN 10 / 100°C	70/5	P-43 / foil bag	0,061	6034500	9,90 zł	
6035500	3/4"-1"	G3/4	G1	21.5	15	34	PN 10 / 100°C	70/5	P-43 / foil bag	0,044	6035500	8,60 zł	

22. TWIST
Złączka do wodomierza

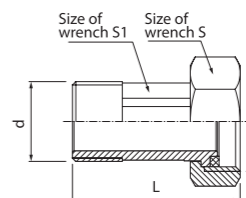

Kod	Rozmiar	Wymiary						P nom. / max temp.	Ilość szt.	Opakow.	Waga netto	Kod	Cena
		D	d	L	S	S1	S1						
6032120	1/2"	G3/4	G1/2	45	29	19	PN 10 / 100°C	100/10	P-1 / foil bag	0,078	6032120	11,10 zł	
6033120	3/4"	G1	G3/4	48	37	24	PN 10 / 100°C	60/10	P-1 / foil bag	0,131	6033120	18,90 zł	
6034120	1"	G1 1/4	G1	53.5	46	30	PN 10 / 100°C	30/5	P-1 / foil bag	0,213	6034120	31,30 zł	

23. TWIST
Zasleпка nakrętna śrutowana

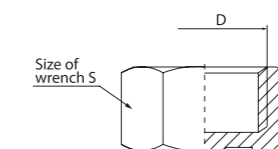

Kod	Rozmiar	Wymiary			P nom. / max temp.	Ilość szt.	Opakow.	Waga netto	Kod	Cena
		D	H	S						
6095200	3/8"	G3/8	11	20	20	300/10	P-43 / foil bag	0,015	6095200	2,30 zł
6095220	1/2"	G1/2	12	24	24	200/10	P-43 / foil bag	0,023	6095220	4,70 zł
6095230	3/4"	G3/4	12	30	30	100/10	P-43 / foil bag	0,037	6095230	6,60 zł
6095240	1"	G1	13	37	37	70/5	P-43 / foil bag	0,059	6095240	8,40 zł

24. TWIST
Zasleпка nakrętna niklowana

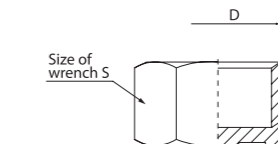

Kod	Rozmiar	Wymiary			P nom. / max temp.	Ilość szt.	Opakow.	Waga netto	Kod	Cena
		D	H	S						
6095250	1/2"	G1/2	12	24	PN 10 / 100°C	200/10	P-43 / foil bag	0,023	6095250	5,20 zł
6095260	3/4"	G3/4	12	30	PN 10 / 100°C	100/10	P-43 / foil bag	0,037	6095260	7,50 zł
6095270	1"	G1	13	37	PN 10 / 100°C	70/5	P-43 / foil bag	0,059	6095270	9,30 zł

25. TWIST

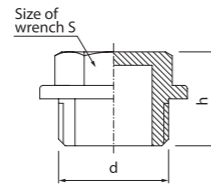
Korek z kolnierzem
śrutowany

Kod	Rozmiar	Wymiary			P nom. / max temp.	Ilość szt.	Opakow.	Waga netto	Kod	Cena
		d	H	S						
6095380	3/8"	G3/8	15	12	PN 10 / 100°C	250/10	P-43 / foil bag	0,015	6095380	2,30 zł
6095350	1/2"	G1/2	17	14	PN 10 / 100°C	500/50	P-1 / wor. 22x25	0,029	6095350	4,70 zł
6095360	3/4"	G3/4	19	17	PN 10 / 100°C	200/50	P-1 / wor. 22x25	0,050	6095360	7,30 zł
6095370	1"	G1	21	27	PN 10 / 100°C	100/25	P-1 / wor. 22x25	0,098	6095370	11,00 zł

26. TWIST

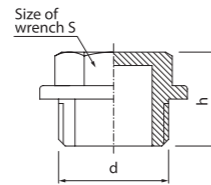
Korek z kolnierzem,
niklowany

Kod	Rozmiar	Wymiary			P nom. / max temp.	Ilość szt.	Opakow.	Waga netto	Kod	Cena
		d	H	S						
6095450	1/2"	G1/2	17	14	PN 10 / 100°C	500/50	P-1 / wor. 22x25	0,029	6095450	4,90 zł
6095460	3/4"	G3/4	19	17	PN 10 / 100°C	200/50	P-1 / wor. 22x25	0,050	6095460	7,70 zł
6095470	1"	G1	21	27	PN 10 / 100°C	100/25	P-1 / wor. 22x25	0,098	6095470	12,60 zł

1. V-PEX
Przylączka prosta śrutowana

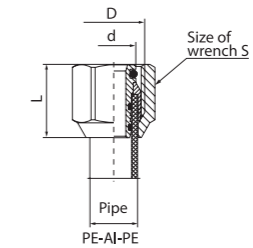

Kod	Wersja	Wymiary				P nom.	Ilość szt.	Opakow.	Waga netto	Kod	Cena
		D	d	L	S						
6007050	12-16 G1/2	G1/2	14	23	24	PN 10	140/20	P-1 / foil bag 22x25	0,050	6007050	11,30 zł
6008050	16-20 G3/4	G3/4	20	28	30	PN 10	90/15	P-1 / foil bag 22x25	0,084	6008050	17,60 zł

2. V-PEX
Przylączka prosta niklowana

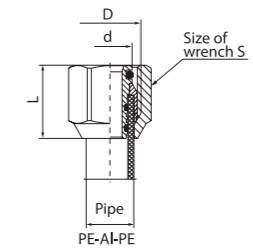

Kod	Wersja	Wymiary				P nom.	Ilość szt.	Opakow.	Waga netto	Kod	Cena
		D	d	L	S						
6007060	12-16 G1/2	G1/2	14	23	24	PN 10	140/20	P-1 / foil bag 22x25	0,050	6007060	12,40 zł
6008040	16-20 G3/4	G3/4	20	28	30	PN 10	90/15	P-1 / foil bag 22x25	0,084	6008040	19,20 zł

3. V-PEX
Przylączka prosta niklowana

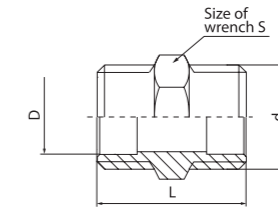

Kod	Wymiar	Wymiary				P nom.	Ilość szt.	Opakow.	Waga netto	Kod	Cena
		D	d	L	S						
6032220	1/2"	14,45	G1/2	29	22	PN 10	150	P-43	0,041	6032220	5,50 zł
6033220	3/4"	20,3	G3/4	36	27	PN 10	80	P-43	0,063	6033220	9,80 zł
6034220	1"	25	G1	38	34	PN 10	40	P-43	0,108	6034220	15,20 zł

4. V-PEX
Przylączka prosta niklowana

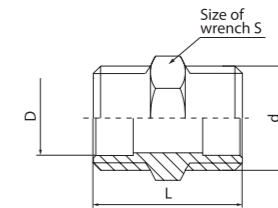

Kod	Wymiar	Wymiary				P nom.	Ilość szt.	Opakow.	Waga netto	Kod	Cena
		D	d	L	S						
6032240	1/2"	14,45	G1/2	29	22	PN 10	150	P-43	0,041	6032240	6,40 zł
6033240	3/4"	20,3	G3/4	36	27	PN 10	80	P-43	0,063	6033240	11,90 zł
6034240	1"	25	G1	38	34	PN 10	40	P-43	0,108	6034240	17,70 zł

5. V-PEX
Złączka wkrętna redukcyjna śrutowana

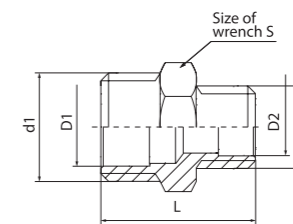

Kod	Wersja	Wymiary						P nom.	Ilość szt.	Opakow.	Waga netto	Kod	Cena
		d1	D1	d2	D2	L	S						
6032410	3/8"-1/2"	G1/2	14,45	G3/8	11	27,5	22	PN 10	150	P-43	0,034	6032410	5,80 zł
6033420	1/2"-3/4"	G3/4	20,3	G1/2	14,45	33,5	27	PN 10	80	P-43	0,058	6033420	10,10 zł
6034420	3/4"-1"	G1	25	G3/4	20,3	37	34	PN 10	50	P-43	0,093	6034420	13,90 zł

6. V-PEX
Złączka nakrętno-wkrętna
redukcyjna śrutowana

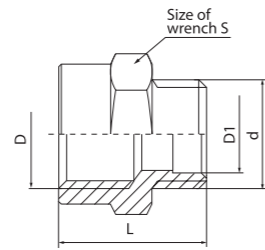

Kod	Wersja	Wymiary					P nom.	Ilość szt.	Opakow.	Waga netto	Kod	Cena
		D	d	D1	L	S						
6037520	1/2"-3/4"	G1/2	G3/4	20,3	32	27	PN 10	100	P-43	0,062	6037520	9,50 zł
6038520	3/4"-1"	G3/4	G1	25	35	34	PN 10	50	P-43	0,107	6038520	15,00 zł

7. V-PEX
Złączka nakrętna śrutowana

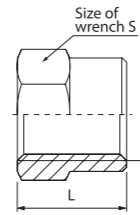

Kod	Wymiar	Wymiary			P nom.	Ilość szt.	Opakow.	Waga netto	Kod	Cena
		D	L	S						
6037110	1/2"	G1/2	25	26	PN 10	100	P-43	0,046	6037110	8,00 zł
6038110	3/4"	G3/4	28	32	PN 10	60	P-43	0,063	6038110	8,70 zł
6039110	1"	G1	31	40	PN 10	40	P-43	0,115	6039110	15,70 zł

8. V-PEX
Kolanko wkrętno śrutowane

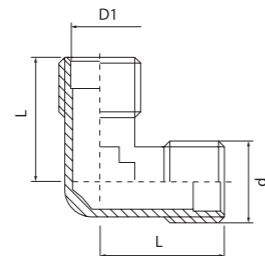

Kod	Wymiar	Wymiary			P nom.	Ilość szt.	Opakow.	Waga netto	Kod	Cena
		D	D1	L						
6042320	1/2"	G1/2	14,45	25	PN 10	80	P-43	0,049	6042320	9,80 zł
6043320	3/4"	G3/4	20,3	30	PN 10	40	P-43	0,117	6043320	16,80 zł

9. V-PEX
Kolanko nakrętno-wkrętno śrutowane

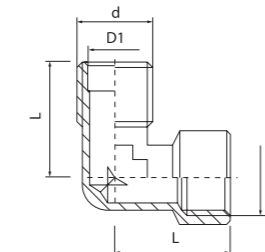

Kod	Wymiar	Wymiary					P nom.	Ilość szt.	Opakow.	Waga netto	Kod	Cena
		D	d	D1	L							
6042420	1/2"	Rp1/2	R1/2	14,45	32	PN 10	50	P-43	0,071	6042420	10,50 zł	
6043420	3/4"	Rp3/4	R3/4	20,3	35	PN 10	30	P-43	0,148	6043420	17,70 zł	
6044420	1"	Rp1	R1	25	40	PN 10	40	P-1	0,178	6044420	24,30 zł	

10. V-PEX
Kolanko nakrętno-wkrętno
niklowane

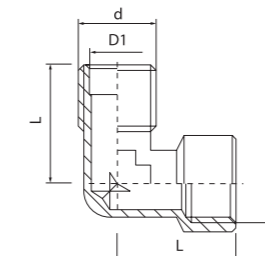

Kod	Wymiar	Wymiary					P nom.	Ilość szt.	Opakow.	Waga netto	Kod	Cena
		D	d	D1	L							
6042400	1/2"	Rp1/2	R1/2	14,45	32	PN 10	50	P-43	0,071	6042400	12,90 zł	
6043400	3/4"	Rp3/4	R3/4	20,3	35	PN 10	30	P-43	0,148	6043400	20,90 zł	

11. V-PEX
Trójnik wkrętny śrutowany

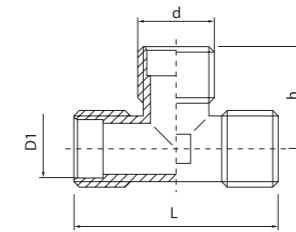

Kod	Wymiar	Wymiary					P nom.	Ilość szt.	Opakow.	Waga netto	Kod	Cena
		d	D1	L	h							
6052320	1/2"	G1/2	14,45	51	25	PN 10	50	P-43	0,064	6052320	10,80 zł	
6053320	3/4"	G3/4	20,3	60	30	PN 10	30	P-43	0,105	6053320	18,10 zł	

12. V-PEX
Kolanko ustalone śrutowane

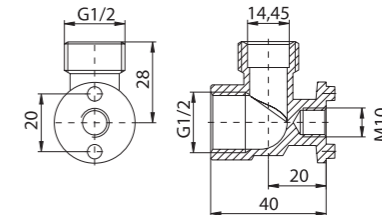

Kod	Wymiar	P nom.	Ilość szt.	Opakow.	Waga netto	Kod	Cena
6022330	1/2"	PN 10	50	P-43	0,096	6022330	13,10 zł

13. V-PEX
Złączka wkrętna redukcyjna
śrutowana

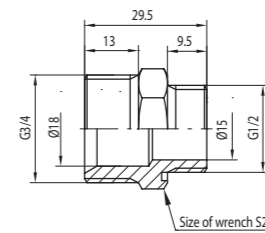

Kod	Wersja	P nom.	Ilość szt.	Opakow.	Waga netto	Kod	Cena
6033440	1/2"-3/4"	PN 10	80	P-43	0,056	6033440	9,30 zł

NASI DOSTAWCY MATERIAŁÓW I CZĘŚCI

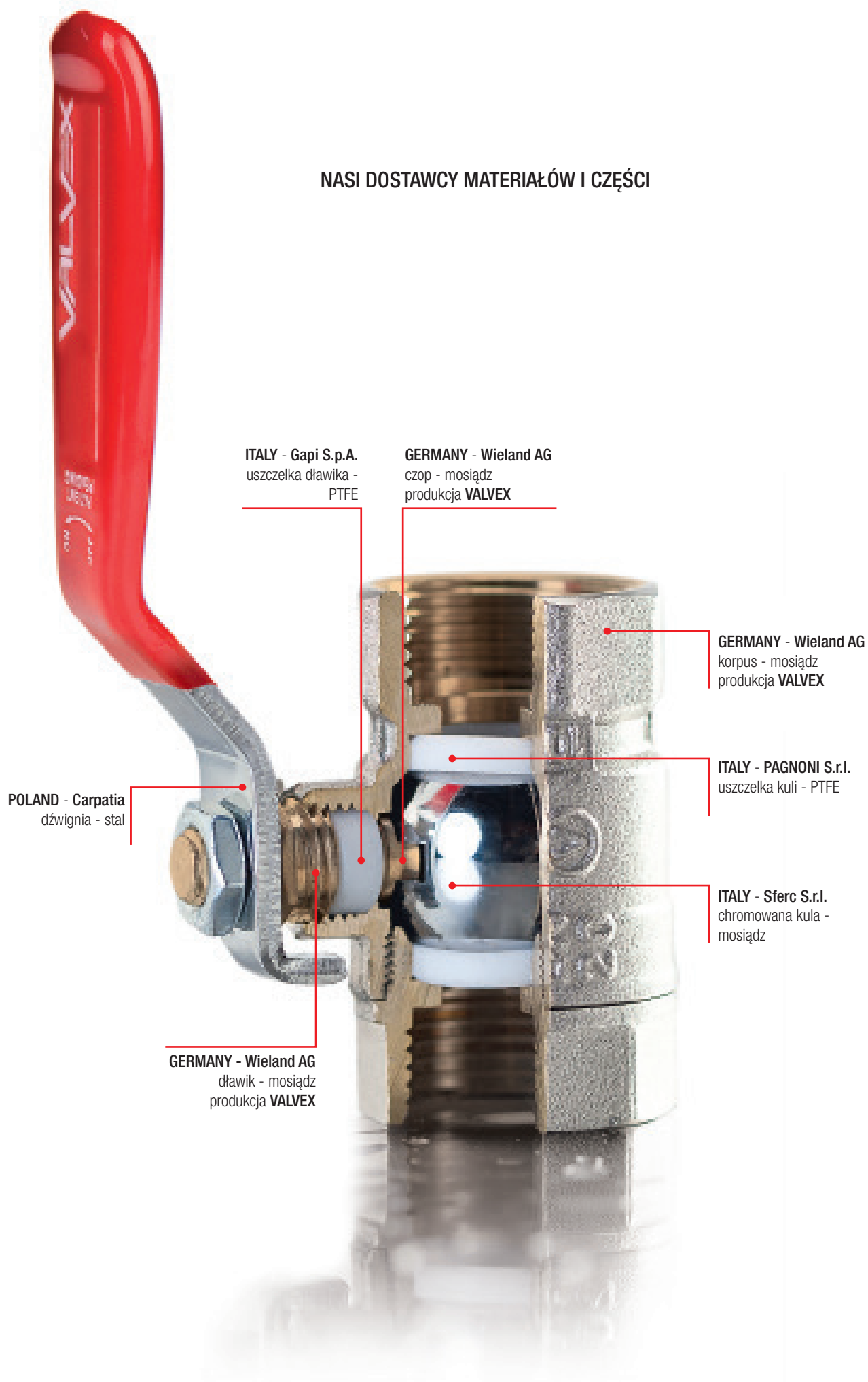



VALVEX S.A.

ul. Nad Skawą 2
34-240 Jordanów, Poland

Tel.: +48 18 269 32 20
Fax: +48 18 269 32 11

e-mail: valvex@valvex.com

www.valvex.com