

armatura
INSTALACYJNA



















CENNIK
1/2017

VALVEX jest znakiem zastrzeżonym Valvex S.A.
i podlega ochronie prawnej. Wszelkie jego powielanie, kopiowanie lub
używanie w jakikolwiek inny sposób bez zgody Valvex S.A. jest zabronione.
Valvex S.A. zastrzega, że wygląd produktów przedstawionych na zdjęciach
może nieznacznie odbiegać od wyglądu rzeczywistego produktów.



Cennik obowiązuje od 16.01.2017 na terenie Rzeczypospolitej Polskiej.
Podane ceny są cenami netto.
Data wydruku: kwiecień 2017

SYMBOLE

25 lat gwarancji Udzielamy 25-letniej gwarancji na elementy odlewane i kute.			Sprężone powietrze
10 lat gwarancji			Glikol
5 lat gwarancji			Instalacje solarne
2 lata gwarancji			Antyalergiczny system - wszystkie elementy zaworu mające styczność z wodą, nie są pokryte niklem
			Głowica ceramiczna
Serwis 48h Gwarancja usługi serwisowej w 48h.			Głowica suwakowa
Ekologia Posiadamy ISO 14001, nasze technologie i produkty są przyjazne dla środowiska.			Metalowa dźwignia
Jakość Posiadamy ISO 9001, nasze produkty wyróżniają się najwyższą jakością.			Bezpieczeństwo przeciwpożarowe
			Instalacje grzewcza / wentylacyjna / klimatyzacyjna
			Łączność bezprzewodowa

SPIIS TREŚCI

ARMATURA INSTALACYJNA WODNA ONYX, TRYTON, ORO, OLIGO, VIKING, OMNI, OPTI, MINI, PURE, ERGO, VEGA, TRANGLE, STRIT, STAR, EKO, EKO PLUS, ANGEL PLUS, BASE, PROFF, OPAL, TIGER, TIGER PLUS, CETUS	4
WEŻYKI PRZYŁĄCZENIOWE VIPER PLUS	16
ARMATURA INSTALACYJNA GAZOWA 4TECH ORION V-GAS	20
ARMATURA INSTALACYJNA CENTRALNEGO OGRZEWANIA THERMO, IRIS, FUSION, VELA, VECTOR, VIRGO, THERMO SET, VECTOR MAX, FUSION 3, THERMO PLUS, VECTOR LUX, ACTIV PLUS, ACTIV, ALFA, BETA, PIZA, PROFF, BASE, PROFF MIX, PROFF CO, COMBI, V-THERM, FEST, BYPASS, SECURE, DIRECT, MINI, VISION, COPPER, PEX, PEX-AL, MICRA, SUBER, AXE, VIRGO, PROTECTIVE CAP, VELA	24
SYSTEMY INSTALACYJNE – ZŁĄCZKI DO RUR STALOWYCH TWIST	48
SYSTEMY INSTALACYJNE – ZŁĄCZKI DO RUR PE-X/AL/PE-X V-PEX	56



1. ONYX - PN 40-30 / 180°C
Kurek kulowy pełnoprzelotowy z dławikiem z dźwignią stalową, wersja nakrętno-nakrętna

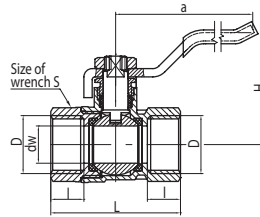

DN	Kod	Wymiar	D	I	dw	L	a	H	S	P nom. / max temp.	Ilość szt	Opakow.	Waga netto	Kod	Cena
10	1451320	3/8"	G3/8	10	10	41,5	90	40	21	PN 40 / 180°C	96/16	P-1	0,1360	1451320	16,30 zł
15	1452320	1/2"	G1/2	12	13,5	47	90	42	25	PN 40 / 180°C	72/12	P-1	0,1573	1452320	18,90 zł
20	1453320	3/4"	G3/4	12	18,5	55	90	46	31	PN 40 / 180°C	60/10	P-1	0,2268	1453320	28,70 zł
25	1454320	1"	G1	14,5	23,5	65	110	50	38	PN 40 / 180°C	36/6	P-1	0,3503	1454320	44,10 zł
32	1455320	1 1/4"	G1 1/4	15	30	75	115,5	65	48	PN 30 / 180°C	24/6	P-1	0,5706	1455320	74,70 zł
40	1456320	1 1/2"	G1 1/2	16	37	84	140	82,5	54	PN 30 / 180°C	8/2	P-1	0,9462	1456320	111,70 zł
50	1457320	2"	G2	18	47	100	140	90	67	PN 30 / 180°C	8/2	P-1	1,4225	1457320	172,70 zł

2. ONYX - PN 16 / 95°C
Kurek kulowy pełnoprzelotowy z dławikiem z dźwignią stalową, wersja nakrętno-nakrętna

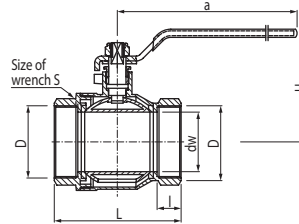

DN	Kod	Wymiar	D	I	dw	L	a	H	S	P nom. / max temp.	Ilość szt	Opakow.	Waga netto	Kod	Cena
65	9007930	2 1/2"	G2 1/2	24	62	136	236	110	82	PN 16 / 95°C	4	P-24	2,547	9007930	352,20 zł
80	9007920	3"	G3	26	74	150	236	119	93	PN 16 / 95°C	3	P-24	3,753	9007920	488,90 zł
100	9007910	4"	G4	28	85	172	240	136	120	PN 16 / 95°C	2	P-24	5,616	9007910	795,10 zł

3. ONYX - PN 40 / 180°C
Kurek kulowy pełnoprzelotowy z dławikiem z motylkiem aluminiowym (MA), wersja nakrętno-nakrętna

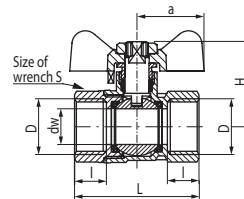

DN	Kod	Wymiar	D	I	dw	L	a	H	S	P nom. / max temp.	Ilość szt	Opakow.	Waga netto	Kod	Cena
15	1452400	1/2"	G1/2	12	13,5	47	25	36	25	PN 40 / 180°C	84/14	P-1	0,132	1452400	18,90 zł
20	1453400	3/4"	G3/4	12	18,5	55	25	40	31	PN 40 / 180°C	72/12	P-1	0,200	1453400	28,70 zł
25	1454400	1"	G1	14,5	23,5	65	32,5	47	38	PN 40 / 180°C	48/8	P-1	0,316	1454400	44,10 zł

4. ONYX - PN 40 / 180°C
Kurek kulowy pełnoprzelotowy z dławikiem z półsrubnikiem z dźwignią stalową

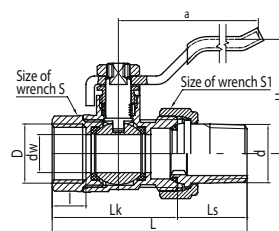

DN	Kod	Wymiar	D	I	dw	L	Lk	d	a	H	S	S1	P nom. / max temp.	Ilość szt	Opakow.	Waga netto	Kod	Cena
15	1452420	1/2"	G1/2	12	13,5	69	44,5	R1/2	90	42	25	30	PN 40 / 180°C	60/10	P-1	0,210	1452420	31,30 zł
20	1453420	3/4"	G3/4	12	18,5	77,5	55	R3/4	90	46	31	37	PN 40 / 180°C	36/6	P-1	0,311	1453420	45,60 zł
25	1454420	1"	G1	14,5	23,5	88,5	58,5	R1	110	50	38	46	PN 40 / 180°C	24/4	P-1	0,482	1454420	68,00 zł

5. ONYX - PN 40 / 180°C
Kurek kulowy pełnoprzelotowy z dławikiem z półsrubnikiem z motylkiem aluminiowym (MA)

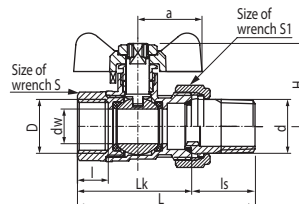

DN	Kod	Wymiar	D	I	dw	L	Lk	d	a	H	S	S1	P nom. / max temp.	Ilość szt	Opakow.	Waga netto	Kod	Cena
15	1452440	1/2"	G1/2	12	13,5	69	44,5	R1/2	25	36,5	25	30	PN 40 / 180°C	60/10	P-1	0,184	1452440	31,30 zł
20	1453440	3/4"	G3/4	12	18,5	77,5	55	R3/4	25	40	31	37	PN 40 / 180°C	36/6	P-1	0,281	1453440	45,60 zł
25	1454440	1"	G1	14,5	23,5	88,5	58,5	R1	32,5	50	38	46	PN 40 / 180°C	24/4	P-1	0,461	1454440	66,60 zł

6. ONYX - PN 30-40 / 180°C

Kurek kulowy pełnoprzelotowy z dławikiem z dźwignią stalową, wersja nakrętno-wkrętna

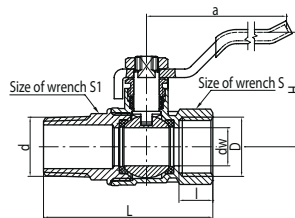

DN	Kod	Wymiar	Wymiary										P nom. / max temp.	Ilość szt.	Opakow.	Waga netto	Kod	Cena
			D	I	dw	L	d	a	H	S	S1							
10	1451460	3/8"	G3/8	10	10	50,5	R3/8	90	40	21	18	PN 40 / 180°C	96/16	P-1	0,142	1451460	20,40 zł	
15	1452460	1/2"	G1/2	12	13,5	60	R1/2	90	42	25	22	PN 40 / 180°C	72/12	P-1	0,169	1452460	23,50 zł	
20	1453460	3/4"	G3/4	12	18,5	68	R3/4	90	46	31	28	PN 40 / 180°C	60/10	P-1	0,245	1453460	32,90 zł	
25	1454460	1"	G1	14,5	23,5	79	R1	110	50	38	35	PN 40 / 180°C	36/6	P-1	0,381	1454460	49,90 zł	
32	1455460	1 1/4"	G1 1/4	15	30	93	R1 1/4	115,5	65	48	44	PN 30 / 180°C	24/6	P-1	0,571	1455460	83,30 zł	
40	1456460	1 1/2"	G1 1/2	16	37	104	R1 1/2	140	82,5	54	52	PN 30 / 180°C	8/2	P-1	0,946	1456460	127,70 zł	
50	1457460	2"	G2	18	47	120	R2	140	90	67	63	PN 30 / 180°C	8/2	P-1	1,423	1457460	194,40 zł	

7. ONYX - PN 40 / 180°C

Kurek kulowy pełnoprzelotowy z dławikiem z motykiem aluminiowym (MAI), wersja nakrętno-wkrętna

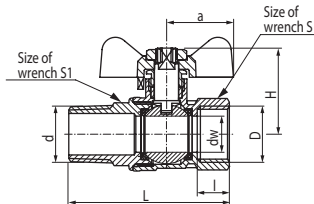

DN	Kod	Wymiar	Wymiary										P nom. / max temp.	Ilość szt.	Opakow.	Waga netto	Kod	Cena
			D	I	dw	L	d	a	H	S	S1							
10	1451480	3/8"	G3/8	10	10	50,5	R3/8	25	34	21	18	PN 40 / 180°C	108/18	P-1	0,114	1451480	20,40 zł	
15	1452480	1/2"	G1/2	12	13,5	60	R1/2	25	36	25	22	PN 40 / 180°C	72/12	P-1	0,146	1452480	23,50 zł	
20	1453480	3/4"	G3/4	12	18,5	68	R3/4	25	40	31	28	PN 40 / 180°C	60/10	P-1	0,222	1453480	32,90 zł	
25	1454480	1"	G1	14,5	23,5	79	R1	32,5	47	38	35	PN 40 / 180°C	36/6	P-1	0,357	1454480	49,90 zł	

8. ONYX - PN 40 / 180°C

Kurek kulowy pełnoprzelotowy z dławikiem z dźwignią stalową, wersja wkrętno-wkrętna

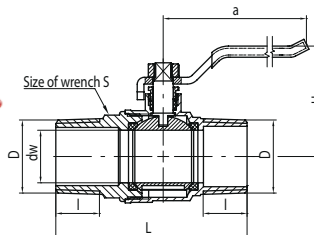

DN	Kod	Wymiar	Wymiary										P nom. / max temp.	Ilość szt.	Opakow.	Waga netto	Kod	Cena
			D	I	dw	L	a	H	S									
15	1452470	1/2"	R1/2	14,5	13,5	64	80	43	23			PN 40 / 180°C	50	P-1	0,169	1452470	24,00 zł	
20	1453470	3/4"	R3/4	16,5	18,5	72,5	80	46	28			PN 40 / 180°C	25	P-1	0,236	1453470	33,40 zł	
25	1454470	1"	R1	19,5	23,5	84	100	50	35			PN 40 / 180°C	15	P-1	0,378	1454470	50,40 zł	

9. ONYX - PN 40 / 180°C

Kurek kulowy pełnoprzelotowy z dławikiem z motykiem aluminiowym (MAI), wersja wkrętno-wkrętna

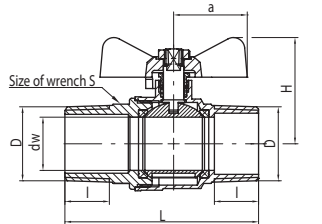

DN	Kod	Wymiar	Wymiary										P nom. / max temp.	Ilość szt.	Opakow.	Waga netto	Kod	Cena
			D	I	dw	L	a	H	S									
15	1452430	1/2"	R1/2	14,5	13,5	64	25	37	23			PN 40 / 180°C	50	P-1	0,142	1452430	24,00 zł	
20	1453430	3/4"	R3/4	16,5	18,5	72,5	25	40	28			PN 40 / 180°C	30	P-1	0,210	1453430	33,40 zł	
25	1454430	1"	R1	19,5	23,5	84	32,5	47	35			PN 40 / 180°C	15	P-1	0,340	1454430	50,40 zł	

10. TRYTON - PN 40 / 140°C - PN 25 / 120°C

Kurek kulowy pełnoprzelotowy z dławikiem z dźwignią stalową, wersja nakrętno-nakrętna

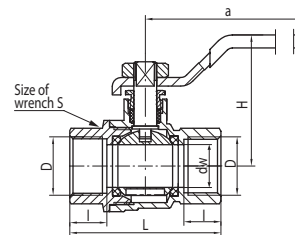

DN	Kod	Wymiar	Wymiary										P nom. / max temp.	Ilość szt.	Opakow.	Waga netto	Kod	Cena
			D	I	dw	L	a	H	S									
10	1451200	3/8"	G3/8	12	10	45	80	44	20			PN 40 / 140°C	16	P-43	0,130	1451200	22,00 zł	
15	1452200	1/2"	G1/2	13	15	53	90	46	25			PN 40 / 140°C	12	P-1	0,201	1452200	29,00 zł	
20	1453200	3/4"	G3/4	15	20	60	100	59	31			PN 40 / 140°C	10	P-1	0,296	1453200	45,20 zł	
25	1454200	1"	G1	16	25	70	115	61	40			PN 40 / 140°C	6	P-1	0,501	1454200	69,00 zł	
32	1455200	1 1/4"	G1 1/4	18	32	84	122	73	48			PN 30 / 120°C	4	P-1	0,777	1455200	112,50 zł	
40	1456200	1 1/2"	G1 1/2	19	40	94	140	79	55			PN 25 / 120°C	2	P-1	1,092	1456200	154,00 zł	
50	1457200	2"	G2	19	50	105	140	98	66			PN 25 / 120°C	3	P-1	1,445	1457200	231,00 zł	

11. TRYTON - PN 40 / 140°C

Kurek kulowy pełnoprzelotowy z dławikiem z motykiem aluminiowym (MAI), wersja nakrętno-nakrętna

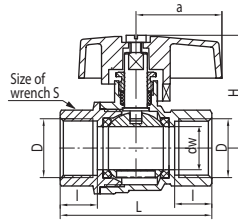

DN	Kod	Wymiar	D	I	dw	L	a	H	S	P nom. / max temp.	Ilość szt	Opakow.	Waga netto	Kod	Cena
15	1452210	1/2"	G1/2	13	15	53	30	42	25	PN 40 / 140°C	14	P-1	0,177	1452210	29,00 zł
20	1453150	3/4"	G3/4	15	20	60	40	47	31	PN 40 / 140°C	12	P-1	0,262	1453150	45,20 zł
25	1454150	1"	G1	16	25	70	40	50	40	PN 40 / 140°C	8	P-1	0,449	1454150	69,00 zł

12. TRYTON - PN 40 / 140°C

Kurek kulowy pełnoprzelotowy z dławikiem z półrubnikiem z dźwignią stalową

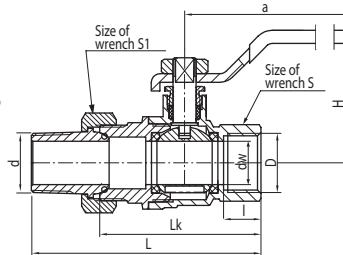

DN	Kod	Wymiar	D	I	dw	L	Lk	d	a	H	S	S1	P nom. / max temp.	Ilość szt	Opakow.	Waga netto	Kod	Cena
15	1452180	1/2"	G1/2	13	15	80	56	R1/2	90	46	25	30	PN 40 / 140°C	10	P-1	0,273	1452180	49,50 zł
20	1453180	3/4"	G3/4	15	20	88	62	R3/4	100	59	31	37	PN 40 / 140°C	6	P-1	0,396	1453180	69,20 zł
25	1454180	1"	G1	16	25	99	71	R1	115	61	40	47	PN 40 / 140°C	4	P-1	0,662	1454180	113,50 zł

13. TRYTON - PN 40 / 140°C

Kurek kulowy pełnoprzelotowy z dławikiem z półrubnikiem z motykiem aluminiowym (MAI)

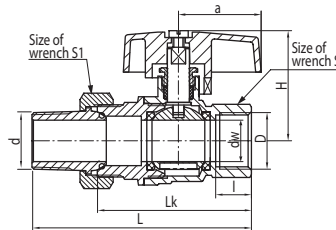

DN	Kod	Wymiar	D	I	dw	L	Lk	d	a	H	S	S1	P nom. / max temp.	Ilość szt	Opakow.	Waga netto	Kod	Cena
15	1452190	1/2"	G1/2	13	15	80	56	R1/2	90	42	25	30	PN 40 / 140°C	10	P-1	0,244	1452190	48,50 zł
20	1453190	3/4"	G3/4	15	20	88	62	R3/4	100	47	31	37	PN 40 / 140°C	6	P-1	0,362	1453190	69,20 zł
25	1454190	1"	G1	16	25	99	71	R1	115	50	40	47	PN 40 / 140°C	4	P-1	0,615	1454190	113,50 zł

14. TRYTON - PN 40 / 140°C

Kurek kulowy pełnoprzelotowy z dławikiem z dźwignią stalową, wersja nakrętno-wkrętna

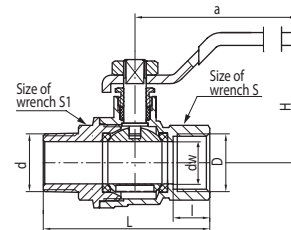

DN	Kod	Wymiar	D	I	dw	L	a	H	d	S	S1	P nom. / max temp.	Ilość szt	Opakow.	Waga netto	Kod	Cena
10	1451160	3/8"	G3/8	12	10	50	80	44	R3/8	20	20	PN 40 / 140°C	16	P-43	0,140	1451160	25,00 zł
15	1452160	1/2"	G1/2	13	15	59	90	46	R1/2	25	25	PN 40 / 140°C	12	P-1	0,212	1452160	34,30 zł
20	1453160	3/4"	G3/4	15	20	65	100	59	R3/4	31	28	PN 40 / 140°C	10	P-1	0,296	1453160	50,20 zł
25	1454160	1"	G1	16	25	77	115	61	R1	40	39	PN 40 / 140°C	6	P-1	0,507	1454160	81,20 zł

15. TRYTON - PN 40 / 140°C

Kurek kulowy pełnoprzelotowy z dławikiem z motykiem aluminiowym (MAI), wersja nakrętno-wkrętna

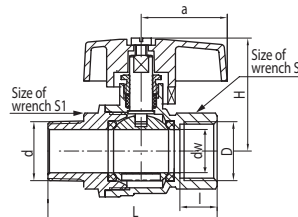

DN	Kod	Wymiar	D	I	dw	L	a	H	d	S	S1	P nom. / max temp.	Ilość szt	Opakow.	Waga netto	Kod	Cena
10	1451170	3/8"	G3/8	12	10	50	80	30	R3/8	20	20	PN 40 / 140°C	18	P-1	0,123	1451170	25,00 zł
15	1452170	1/2"	G1/2	13	15	59	90	30	R1/2	25	25	PN 40 / 140°C	12	P-1	0,186	1452170	34,30 zł
20	1453170	3/4"	G3/4	15	20	65	100	40	R3/4	31	28	PN 40 / 140°C	10	P-1	0,263	1453170	50,20 zł
25	1454170	1"	G1	16	25	77	115	40	R1	40	39	PN 40 / 140°C	6	P-1	0,461	1454170	81,20 zł

16. ORO - PN 16 / 120°C

Kurek kulowy z dławikiem z dźwignią stalową, wersja nakrętno-nakrętna

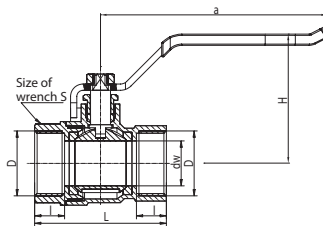

DN	Kod	Wymiar	D	I	dw	L	a	H	S	P nom. / max temp.	Ilość szt	Opakow.	Waga netto	Kod	Cena
15	1472600	1/2"	G1/2	11	13,5	45	90	49	24	PN 16 / 120°C	72/12	P-1	0,140	1472600	12,90 zł
20	1473600	3/4"	G3/4	12	18	53	90	52	30	PN 16 / 120°C	60/10	P-1	0,200	1473600	19,10 zł
25	1474600	1"	G1	14	22	62	110	59	37	PN 16 / 120°C	36/6	P-1	0,335	1474600	29,80 zł
32	1475600	1 1/4"	G1 1/4	15	27	71	110	65	46	PN 16 / 120°C	24/6	P-1	0,450	1475600	45,10 zł
40	1476600	1 1/2"	G1 1/2	16	34	81	140	78	52	PN 16 / 120°C	16/4	P-1	0,700	1476600	75,30 zł
50	1477600	2"	G2	21	43	101	140	85	68	PN 16 / 120°C	8/2	P-1	1,100	1477600	126,30 zł

17. ORO - PN 16 / 120°C

Kurek kulowy z dławikiem z motylkiem aluminiowym (MAI), wersja nakrętno-nakrętna

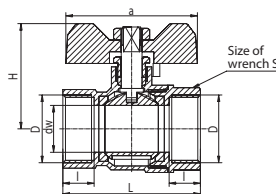

DN	Kod	Wymiar	D	I	dw	L	a	H	S	P nom. / max temp.	Ilość szt	Opakow.	Waga netto	Kod	Cena
15	1472620	1/2"	G1/2	11	13,5	45	50	38,5	24	PN 16 / 120°C	84/14	P-1	0,120	1472620	13,60 zł
20	1473620	3/4"	G3/4	12	18	53	50	40,5	30	PN 16 / 120°C	72/12	P-1	0,180	1473620	20,10 zł
25	1474620	1"	G1	14	22	62	63	49	37	PN 16 / 120°C	48/8	P-1	0,285	1474620	32,60 zł

18. ORO - PN 16 / 120°C

Kurek kulowy dławikiem z dźwignią stalową, wersja nakrętno-wkrętna

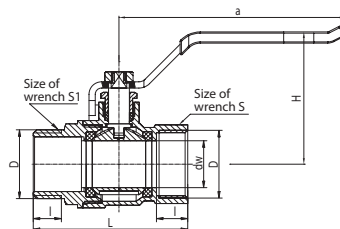

DN	Kod	Wymiar	D	I	dw	L	a	H	S	S1	P nom. / max temp.	Ilość szt	Opakow.	Waga netto	Kod	Cena
15	1472640	1/2"	G1/2	11	13,5	52	90	49	24	22	PN 16 / 120°C	72/12	P-1	0,145	1472640	16,80 zł
20	1473640	3/4"	G3/4	12	18	58	90	52	30	28	PN 16 / 120°C	60/10	P-1	0,210	1473640	23,10 zł
25	1474640	1"	G1	14	22	70	110	59	37	35	PN 16 / 120°C	36/6	P-1	0,360	1474640	38,30 zł

19. ORO - PN 16 / 120°C

Kurek kulowy z dławikiem z motylkiem aluminiowym (MAI), wersja nakrętno-wkrętna

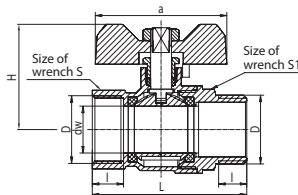

DN	Kod	Wymiar	D	I	dw	L	a	H	S	S1	P nom. / max temp.	Ilość szt	Opakow.	Waga netto	Kod	Cena
15	1472660	1/2"	G1/2	11	13,5	52	50	38,5	24	22	PN 16 / 120°C	72/12	P-1	0,125	1472660	15,00 zł
20	1473660	3/4"	G3/4	12	18	58	50	40,5	30	28	PN 16 / 120°C	60/10	P-1	0,190	1473660	20,30 zł
25	1474660	1"	G1	14	22	70	63	49	37	35	PN 16 / 120°C	36/6	P-1	0,310	1474660	34,00 zł

20. ORO - PN 16 / 120°C

Kurek kulowy pełnoprzelotowy z dławikiem z półsrubunkiem z motylkiem aluminiowym (MAI)

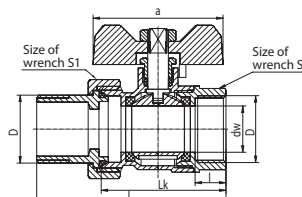

DN	Kod	Wymiar	D	I	dw	L	Lk	a	H	S	S1	P nom. / max temp.	Ilość szt	Opakow.	Waga netto	Kod	Cena
15	1472680	1/2"	G1/2	11	13,5	62,5	40,5	50	38,5	24	29	PN 16 / 120°C	60/10	P-1	0,162	1472680	20,50 zł
20	1473680	3/4"	G3/4	12	18	73,5	48,5	50	40,5	30	37	PN 16 / 120°C	36/6	P-1	0,255	1473680	31,50 zł
25	1474680	1"	G1	14	22	85	57	63	49	37	47	PN 16 / 120°C	24/4	P-1	0,420	1474680	51,40 zł

21. OLIGO

Kurek kulowy czerpalny z dławikiem z dźwignią stalową (DST)

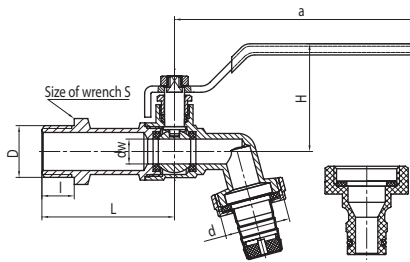

* Kurek kulowy 1" dostępny tylko z końcówką stalową

DN	Kod	Wymiary										P nom. / max temp.	Ilość szt	Opakow.	Waga netto	Kod	Cena
		Wymiar	D	L	dw	L	a	H	S	d							
15	1592200	1/2"	G1/2	13	10	54	92	44	24	G3/4	PN 10 / 65°C	100/10/1	P-1	0,190	1592200	21,70 zł	
20	1593200	3/4"	G3/4	14	12,5	60	92	46	28	G1	PN 10 / 65°C	80/8/1	P-1	0,260	1593200	28,30 zł	
25	1594200*	1"	G1	15	14,5	68	110	53	35	G1 1/4	PN 10 / 65°C	60/6/1	P-1	0,400	1594200*	44,30 zł	

22. OLIGO

Kurek kulowy czerpalny z dławikiem z motylkiem aluminiowym (MA)

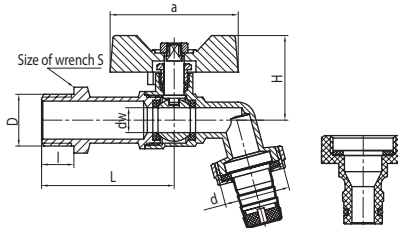

* Kurek kulowy 1" dostępny tylko z końcówką stalową

DN	Kod	Wymiary										P nom. / max temp.	Ilość szt	Opakow.	Waga netto	Kod	Cena
		Wymiar	D	L	dw	L	a	H	S	d							
15	1592100	1/2"	G1/2	13	10	54	52	34	24	G3/4	PN 10 / 65°C	100/10/1	P-1	0,190	1592100	21,70 zł	
20	1593100	3/4"	G3/4	14	12,5	60	52	36	28	G1	PN 10 / 65°C	80/8/1	P-1	0,260	1593100	28,30 zł	
25	1594100*	1"	G1	15	14,5	68	67	43	35	G1 1/4	PN 10 / 65°C	60/6/1	P-1	0,400	1594100*	44,30 zł	

23. VIKING

Zawór wypływowy żeliwny z końcówką do węża z szybkozłączem

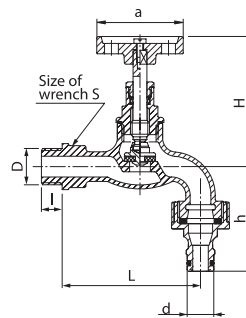

DN	Kod	Wymiary										P nom. / max temp.	Ilość szt	Opakow.	Waga netto	Kod	Cena
		Wymiar	D	L	a	H	h	d	S								
15	1112200	1/2"	G1/2	12	80	50	75-83	60	15,4	24	PN 10 / 65°C	6	P-1	0,323	1112200	37,00 zł	
20	1113200	3/4"	G3/4	14	100	50	85-95	67,5	15,4	24	PN 10 / 65°C	4	P-1	0,529	1113200	53,90 zł	

24. OMNI

Kurek kulowy spustowy z dźwignią aluminiową (DAI) do podłączenia węża z szybkozłączem

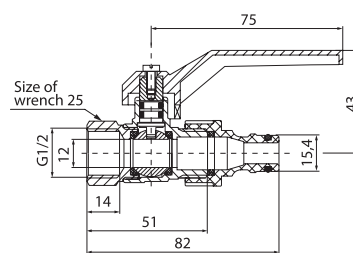

DN	Kod	Wymiar	P nom. / max temp.	Ilość szt	Opakow.	Waga netto	Kod	Cena
15	1582010	1/2"	PN 10 / 65°C	10	P-1	0,144	1582010	29,00 zł

25. OMNI

Kurek kulowy spustowy ze złączką do węża i zaślepką

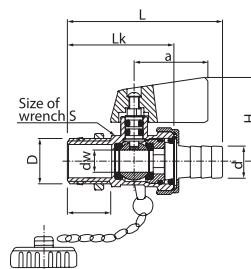

DN	Kod	Wymiary										P nom. / max temp.	Ilość szt	Opakow.	Waga netto	Kod	Cena
		Wymiar	D	L	dw	L	Lk	d	a	H	S						
15	1582280	1/2"	G1/2	15	10	72	50	15	34	35	23	PN 10 / 90°C	10	P-1	0,153	1582280	25,50 zł
20	1583280	3/4"	G3/4	17	15	84	55	20	34	40	30	PN 10 / 90°C	6	P-1	0,267	1583280	41,50 zł

26. OMNI

Kurek kulowy spustowy śrutowany ze złączką do węża i zaślepką

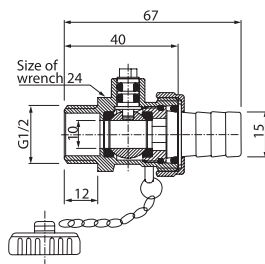

DN	Kod	Wymiar	P nom. / max temp.	Ilość szt	Opakow.	Waga netto	Kod	Cena
15	1582290	1/2"	PN 10 / 90°C	24/3	P-1	0,116	1582290	23,90 zł

27. ONYX

Kurek kulowy z korkiem, zaworkiem spustowym i dławikiem z dźwignią stalową

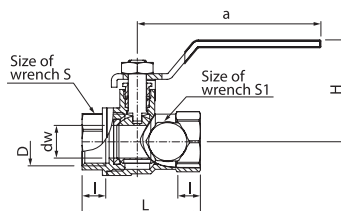

DN	Kod	Wymiar	Wymiary								P nom. / max temp.	Ilość szt	Opakow.	Waga netto	Kod	Cena
			D	I	dw	L	a	H	S	S1						
15	1452650	1/2"	G1/2	10,5	15	53	81,5	45	25	17	PN 25 / 95°C	6	P-1	0,234	1452650	36,90 zł
20	1453650	3/4"	G3/4	11,5	19	60	104	48	31	17	PN 25 / 95°C	4	P-1	0,320	1453650	48,30 zł
25	1454650	1"	G1	12	25	70	104	57	38	17	PN 25 / 95°C	4	P-1	0,467	1454650	66,00 zł
32	1455650	1" 1/4"	G1 1/4	13	31	80	120	67,5	47	17	PN 16 / 95°C	4	P-1	0,650	1455650	99,90 zł
40	1456650	1" 1/2"	G1 1/2	14	40	91	120	73	54	17	PN 16 / 95°C	2	P-1	0,932	1456650	139,90 zł
50	1457650	2"	G2	16	50	107	142	87,5	66	17	PN 16 / 95°C	3	P-1	1,463	1457650	219,00 zł

28. OPTI

Kurek kulowy śrutowany z filtrem skośnym i dławikiem

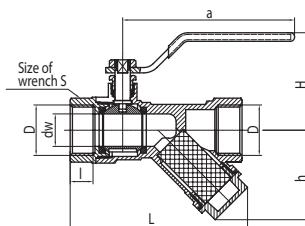

DN	Kod	Wymiar	Wymiary								P nom. / max temp.	Ilość szt	Opakow.	Waga netto	Kod	Cena
			D	I	dw	L	a	H	h	S						
15	1470020	1/2"	G1/2	13	15	84	90	50,5	38	25	PN 25 / 95°C	72/36/6	P-1	0,258	1470020	32,00 zł
20	1470030	3/4"	G3/4	13	17	93	90	52	47	30	PN 25 / 95°C	48/24/4	P-1	0,369	1470030	46,00 zł
25	1470040	1"	G1	14,5	22	105	105	61,5	50	38	PN 25 / 95°C	48/24/4	P-1	0,633	1470040	62,30 zł

29. MINI

Kurek kulowy chromowany, wersja nakrętno-wkrętna

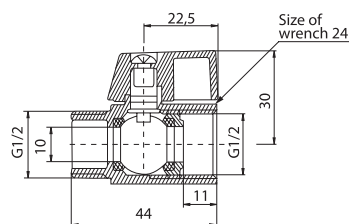

DN	Kod	Wymiar	P nom. / max temp.	Ilość szt	Opakow.	Waga netto	Kod	Cena
15	1470010	1/2"	PN 10 / 90°C	250/25	P-1 / foil bag 22x25	0,099	1470010	16,90 zł

30. MINI

Kurek kulowy chromowany, wersja nakrętno-wkrętna

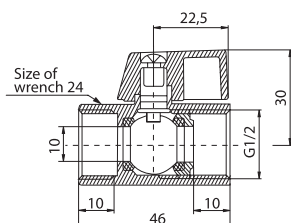

DN	Kod	Wymiar	P nom. / max temp.	Ilość szt	Opakow.	Waga netto	Kod	Cena
15	1470000	1/2"	PN 10 / 90°C	250/25	P-1 / foil bag 22x25	0,115	1470000	18,50 zł

31. PURE
Zawór antyskażeniowy mosiężny
typ EA

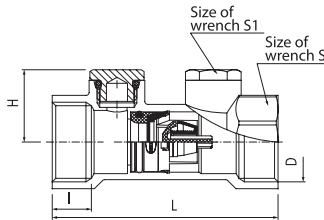

DN	Kod	Wymiary								P nom. / max temp.	Ilość szt	Opakow.	Waga netto	Kod	Cena
		Wymiar	D	I	L	H	S	S1							
15	1901000	1/2"	G1/2	11	65	21,5	26	16	PN 10 / 65°C	32	P-43	0,147	1901000	30,50 zł	
20	1901050	3/4"	G3/4	13	75	24	31	16	PN 10 / 65°C	30	P-43	0,177	1901050	35,50 zł	
25	1901100	1"	G1	14	90	27	38	16	PN 10 / 65°C	12	P-43	0,275	1901100	50,70 zł	
32	1901150	1" 1/4"	G1 1/4	16	100	30	48	16	PN 10 / 65°C	8	P-43	0,399	1901150	91,00 zł	

32. ERGO
Zawór grzybkowy kątowy

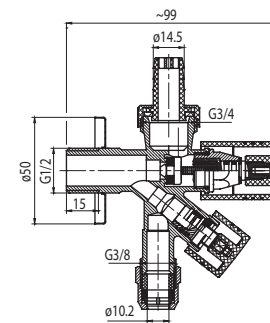

Kod	Wymiary	P nom.	Ilość szt	Opakow.	Waga netto	Kod	Cena
1482100	1/2"-3/8"-3/4"	PN 10 / 80°C	72/1	-	0,240	1482100	55,00 zł

33. VEGA
Zawór kątowy chromowany z głowicą ceramiczną

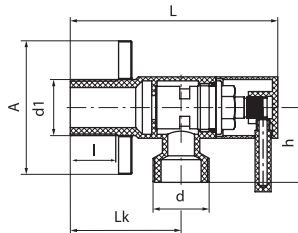

Kod	Wymiary								P nom.	Ilość szt	Opakow.	Waga netto	Kod	Cena
	Wymiar	A	L	I	Lk	d	d1	h						
1482840	1/2"-3/8"	50	77,7	18	41,5	G3/8	G1/2	26	PN 10 / 100°C	16/1	P-21 / P-EK017A	0,141	1482840	38,00 zł
1482740	1/2"-1/2"	50	77,7	18	41,5	G1/2	G1/2	28	PN 10 / 100°C	16/1	P-21 / P-EK013A	0,143	1482740	38,90 zł
1483130	1/2"-3/4"	50	84	14	45,5	G3/4	G1/2	29	PN 10 / 100°C	16/1	P-21 / P-EK022A	0,158	1483130	41,30 zł

34. TRANGLE
Zawór kątowy chromowany z głowicą ceramiczną

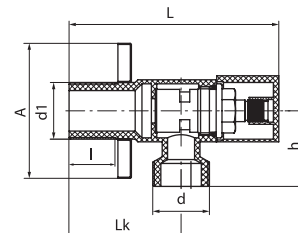

Kod	Wymiary								P nom. / max temp.	Ilość szt	Opakow.	Waga netto	Kod	Cena
	Wymiar	A	L	I	Lk	d	d1	h						
1482810	1/2"-3/8"	50	77,7	18	41,5	G3/8	G1/2	26	PN 10 / 100°C	16/1	P-21 / P-EK017A	0,161	1482810	36,80 zł
1482770	1/2"-1/2"	50	77,7	18	41,5	G1/2	G1/2	28	PN 10 / 100°C	16/1	P-21 / P-EK013A	0,172	1482770	38,30 zł
1483140	1/2"-3/4"	50	84	13	45,5	G3/4	G1/2	29	PN 10 / 100°C	16/1	P-21 / P-EK022A	0,189	1483140	41,10 zł

35. STRIT
Zawór kątowy chromowany z głowicą ceramiczną

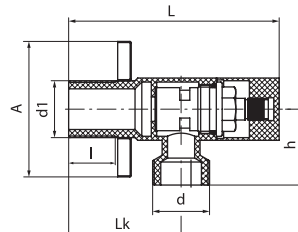

Kod	Wymiary								P nom. / max temp.	Ilość szt	Opakow.	Waga netto	Kod	Cena
	Wymiar	A	L	I	Lk	d	d1	h						
1482870	1/2"-3/8"	50	77,7	18	41,5	G3/8	G1/2	26	PN 10 / 100°C	16/1	P-21 / P-EK019A	0,141	1482870	38,60 zł
1482750	1/2"-1/2"	50	77,7	18	41,5	G1/2	G1/2	28	PN 10 / 100°C	16/1	P-21 / P-EK014A	0,141	1482750	39,70 zł
1483120	1/2"-3/4"	50	84	14	45,5	G3/4	G1/2	29	PN 10 / 100°C	16/1	P-21 / P-EK021A	0,162	1483120	42,30 zł

36. STAR
Zawór kątowy chromowany z głowicą ceramiczną

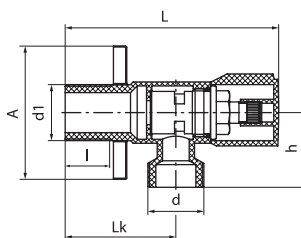

Kod	Wymiary							P nom. / max temp.	Ilość szt	Opakow.	Waga netto	Kod	Cena	
	Wymiar	A	L	l	Lk	d	d1							h
1482860	1/2"-3/8"	50	80	18	41,5	G3/8	G1/2	26	PN 10 / 100°C	16/1	P-21 / P-EK018A	0,115	1482860	30,20 zł
1482670	1/2"-1/2"	50	80	18	41,5	G1/2	G1/2	28	PN 10 / 100°C	16/1	P-21 / P-EK012A	0,124	1482670	31,00 zł
1483110	1/2"-3/4"	50	86	13	45,5	G3/4	G1/2	29	PN 10 / 100°C	16/1	P-21 / P-EK020A	0,141	1483110	31,90 zł

37. EKO
Kurek kątowy chromowany z nakrętką (do podłączenia baterii)

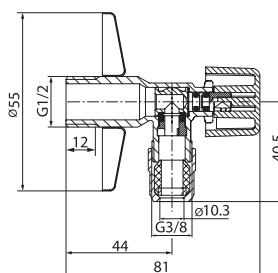

Kod	Wymiar	P nom. / max temp.	Ilość szt	Opakow.	Waga netto	Kod	Cena
1482170	1/2"-3/8"-M10	PN 10 / 90°C	10/1	P-25 / P-EK07A	0,115	1482170	21,00 zł

38. EKO
Kurek kątowy chromowany

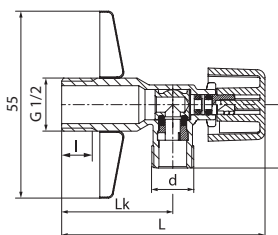

Kod	Wymiary							P nom. / max temp.	Ilość szt	Opakow.	Waga netto	Kod	Cena
	Wymiar	L	l	Lk	d	h							
1482110	1/2"-3/8"	81	12	44	G3/8	25	PN 10 / 90°C	10/1	P-21 / P-EK01A	0,098	1482110	17,40 zł	
1482120	1/2"-1/2"	81	12	44	G1/2	25	PN 10 / 90°C	10/1	P-21 / P-EK02A	0,102	1482120	18,20 zł	
1482130	1/2"-3/4"	81	12	44	G3/4	28	PN 10 / 90°C	10/1	P-21 / P-EK03A	0,116	1482130	20,00 zł	

39. EKO PLUS
Kurek kątowy chromowany z nakrętką (do podłączenia baterii)

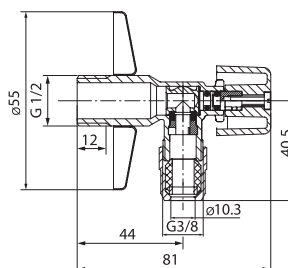

Kod	Wymiar	P nom. / max temp.	Ilość szt	Opakow.	Waga netto	Kod	Cena
1482660	1/2"-3/8"-M10	PN 10 / 90°C	10/1	P-25 / P-EK011A	0,152	1482660	25,00 zł

40. EKO PLUS
Kurek kątowy chromowany

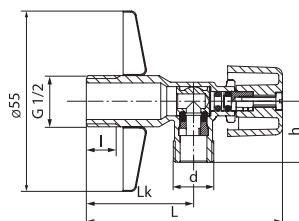

Kod	Wymiary							P nom. / max temp.	Ilość szt	Opakow.	Waga netto	Kod	Cena
	Wymiar	L	l	Lk	d	h							
1482620	1/2"-3/8"	81	12	44	G3/8	25	PN 10 / 90°C	10/1	P-25 / P-EK08A	0,136	1482620	22,50 zł	
1482630	1/2"-1/2"	81	12	44	G1/2	25	PN 10 / 90°C	10/1	P-25 / P-EK09A	0,140	1482630	24,20 zł	
1482640	1/2"-3/4"	81	12	44	G3/4	28	PN 10 / 90°C	10/1	P-25 / P-EK010A	0,154	1482640	25,80 zł	

46. PROFF
Zawór grzybkowy kątowy chromowany

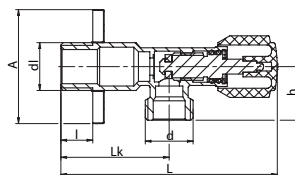

Kod	Wymiar	Wymiary							P nom. / max temp.	Ilość szt	Opakow.	Waga netto	Kod	Cena
		A	L	I	Lk	d	d1	h						
1484100	1/2"-3/8"	50	95	14	47,5	G3/8	G1/2	23,5	PN 10 / 100°C	10/1	P-25 / P-K10	0,109	1484100	15,60 zł
1484110	1/2"-1/2"	50	95	14	47,5	G1/2	G1/2	23,5	PN 10 / 100°C	10/1	P-25 / P-K11	0,116	1484110	16,30 zł
1484120	1/2"-3/4"	50	95	14	47,5	G3/4	G1/2	23,5	PN 10 / 100°C	10/1	P-25 / P-K12	0,123	1484120	17,40 zł

47. OPAL
Zawór grzybkowy kątowy chromowany z nakrętką (do podłączenia baterii)

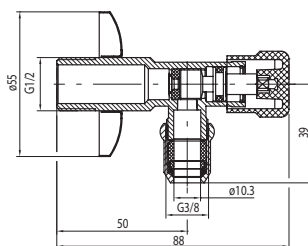

Kod	Wymiar	P nom. / max temp.	Ilość szt	Opakow.	Waga netto	Kod	Cena
1282500	1/2"-3/8-M10	PN 10 / 100°C	10/1	P-25 / P-K9	0,128	1282500	25,00 zł

48. OPAL
Zawór grzybkowy kątowy chromowany

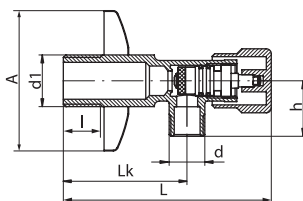

Kod	Wymiar	Wymiary							P nom. / max temp.	Ilość szt	Opakow.	Waga netto	Kod	Cena
		A	L	I	Lk	d	d1	h						
1282510	1/2"-3/8"	55	88	15	50	G3/8	G1/2	23	PN 10 / 100°C	10/1	P-25 / P-K10	0,109	1282510	20,40 zł
1282520	1/2"-1/2"	55	88	15	50	G1/2	G1/2	23	PN 10 / 100°C	10/1	P-25 / P-K11	0,116	1282520	21,00 zł
1282530	1/2"-3/4"	55	88	15	50	G3/4	G1/2	23	PN 10 / 100°C	10/1	P-25 / P-K12	0,123	1282530	21,50 zł

49. VIKING
Zawór przelotowy żeliwny (M 83)

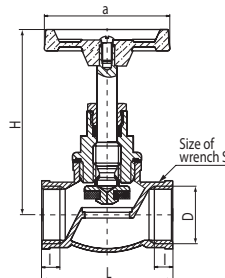

DN	Kod	Wymiary							P nom. / max temp.	Ilość szt	Opakow.	Waga netto	Kod	Cena
		Wymiar	D	L	I	H	a	S						
15	1292010	1/2"	G1/2	61	12	81	50	27	PN 10 / 100°C	10	P-1	0,262	1292010	23,50 zł
20	1293010	3/4"	G3/4	70	13	93	50	31	PN 10 / 100°C	8	P-1	0,396	1293010	29,00 zł
25	1294010	1"	G1	86	14	104	50	40	PN 10 / 100°C	5	P-1	0,648	1294010	40,50 zł
32	1295010	1 1/4"	G1 1/4	101	15	132	80	49	PN 10 / 100°C	5	P-1	1,229	1295010	82,50 zł
40	1296010	1 1/2"	G1 1/2	116	19	150	80	57	PN 10 / 100°C	4	P-1	1,702	1296010	112,00 zł
50	1297010	2"	G2	141,5	21	175	100	69	PN 10 / 100°C	2	P-24	2,710	1297010	179,00 zł

50. TIGER
Zawór zwrotny ze sprężyną

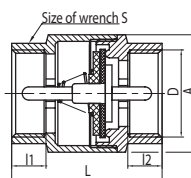

DN	Kod	Wymiary							P nom. / max temp.	Ilość szt	Opakow.	Waga netto	Kod	Cena
		Wymiar	D	A	L	I	I1	S						
15	1900000	1/2"	G1/2	33	45	11	11	25	PN 10 / 100°C	150/25	P-43	0,116	1900000	15,50 zł
20	1900010	3/4"	G3/4	38	48	13	12	31	PN 10 / 100°C	120/20	P-1	0,178	1900010	23,00 zł
25	1900020	1"	G1	44	57	13	13	38	PN 10 / 100°C	60/10	P-1	0,233	1900020	29,10 zł
32	1900030	1 1/4"	G1 1/4	59	66,5	19	15	46	PN 10 / 100°C	30/5	P-1	0,324	1900030	46,00 zł
40	1900040	1 1/2"	G1 1/2	68,5	68	18,5	16	52	PN 10 / 100°C	24/4	P-1	0,483	1900040	67,00 zł
50	1900050	2"	G2	82,5	78	19	16,5	65	PN 10 / 100°C	5	P-1	0,701	1900050	99,00 zł

51. TIGER PLUS

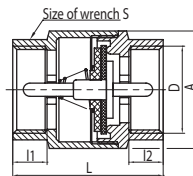
Zawór zwrotny ze sprężyną
z metalowym trzpieniem

DN	Kod	Wymiary							P nom. / max temp.	Ilość szt	Opakow.	Waga netto	Kod	Cena
		Wymiar	D	A	L	I	I1	S						
15	1900200	1/2"	G1/2	33	45	11	11	25	PN 10 / 120°C	150/25	P-43	0,140	1900200	18,40 zł
20	1900210	3/4"	G3/4	38	48	13	12	31	PN 10 / 120°C	120/20	P-1	0,210	1900210	25,90 zł
25	1900220	1"	G1	44	57	13	13	38	PN 10 / 120°C	60/10	P-1	0,259	1900220	37,40 zł
32	1900230	1" 1/4"	G1 1/4	59	66.5	19	15	46	PN 10 / 120°C	30/5	P-1	0,420	1900230	56,20 zł
40	1900240	1" 1/2"	G1 1/2	68.5	68	18.5	16	52	PN 10 / 120°C	24/4	P-1	0,584	1900240	82,10 zł
50	1900250	2"	G2	82.5	78	19	16.5	65	PN 10 / 120°C	5	P-1	0,822	1900250	126,20 zł

52. TIGER

Kosz ssawny (do zaworów zwrotnych)

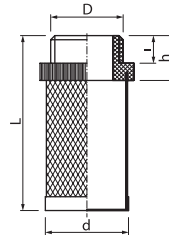

Kod	Wymiary							Ilość szt	Opakow.	Waga netto	Kod	Cena
	Wymiar	D	L	I	h	d						
1900140	1/2"	G1/2	42	8	13	24	25	P-43	0,007	1900140	4,20 zł	
1900150	3/4"	G3/4	44	7	12	30	20	P-43	0,009	1900150	5,60 zł	
1900160	1"	G1	56	10	15	36	20	P-43	0,016	1900160	7,60 zł	
1900170	1 1/4"	G1 1/4	62	10	15	43	15	P-43	0,018	1900170	9,20 zł	
1900180	1 1/2"	G1 1/2	70	10	16	53	10	P-43	0,027	1900180	10,90 zł	
1900190	2"	G2	82	12	18	63	10	P-1	0,037	1900190	13,90 zł	

53. CETUS

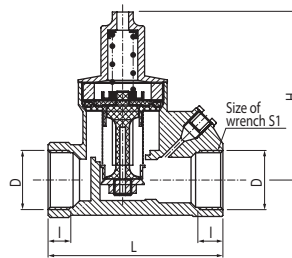
Reduktor ciśnienia śrutowany wersja
nakrętno-nakrętna

DN	Kod	Wymiary							P nom. / max temp.	Ilość szt	Opakow.	Waga netto	Kod	Cena
		Wymiar	D	L	H	S								
15	1900300	1/2"	G1/2	68	11,5	70	27	PN 16 / 75°C	18/1	P-86 / P-R1	0,431	1900300	169,00 zł	
20	1900310	3/4"	G3/4	71	12	75	31,5	PN 16 / 75°C	18/1	P-86 / P-R1	0,399	1900310	173,00 zł	

54. CETUS

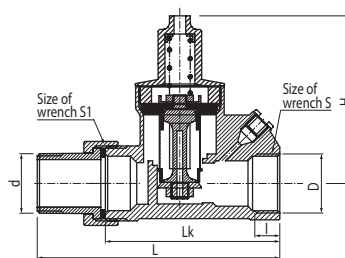
Reduktor ciśnienia
z półśrubunkiem śrutowany

DN	Kod	Wymiary									P nom. / max temp.	Ilość szt	Opakow.	Waga netto	Kod	Cena
		Wymiar	D	L	Lk	d	H	S	S1							
15	1900320	1/2"	G1/2	11,5	96	68	R1/2	70	27	30	PN 16 / 75°C	18/1	P-86 / P-R2	0,476	1900320	187,00 zł
20	1900330	3/4"	G3/4	12	103	71	R3/4	75	31,5	37	PN 16 / 75°C	18/1	P-86 / P-R2	0,550	1900330	203,00 zł

55. VIKING

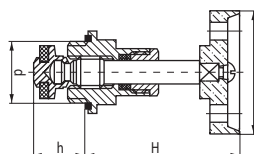
Głowica do zaworów przelotowych
żeliwnych

Kod	Wymiary					P nom. / max temp.	Ilość szt	Opakow.	Waga netto	Kod	Cena
	Wymiar	a	H	h	d						
0112080	1/2"	50	58	22	G1/2	PN 10 / 100°C	32/4	P-1	0,095	0112080	14,40 zł
0113080	3/4"	50	65	25	G3/4	PN 10 / 100°C	24/3	P-1	0,136	0113080	18,30 zł
0114080	1"	50	70	31	G1	PN 10 / 100°C	16/2	P-1	0,190	0114080	23,60 zł
0105050	1 1/4"	80	92	34	G1 1/4	PN 10 / 100°C	10/1	P-1	0,413	0105050	49,00 zł
0106050	1 1/2"	80	104	40	G1 1/2	PN 10 / 100°C	8/1	P-1	0,530	0106050	58,50 zł
0107050	2"	100	122	46	G2	PN 10 / 100°C	6/1	P-1	0,937	0107050	91,00 zł



1. VIPER PLUS - 3/8"

Wężyk do baterii z krótką końcówką

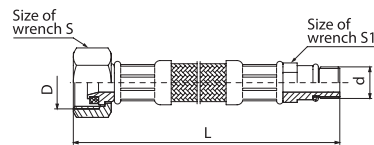

Kod	Wersja	Wymiary					P nom. / max temp.	Ilość szt.	Opakow.	Waga netto	Kod	Cena
		D	d	L	S	S1						
2902010	3/8"-M8x1-L350	G3/8	M8x1	350	19	10	PN 10 / 90°C	20/1	P-21	0,077	2902010	9,40 zł
2902030	3/8"-M8x1-L600	G3/8	M8x1	600	19	10	PN 10 / 90°C	20/1	P-29	0,114	2902030	10,30 zł
2902040	3/8"-M10x1-L350	G3/8	M10x1	350	19	10	PN 10 / 90°C	20/1	P-21	0,078	2902040	11,70 zł
2902050	3/8"-M10x1-L450	G3/8	M10x1	450	19	10	PN 10 / 90°C	20/1	P-28	0,092	2902050	13,40 zł
2902120	3/8"-M10x1-L500	G3/8	M10x1	500	19	10	PN 10 / 90°C	20/1	P-28	0,102	2902120	13,60 zł
2902060	3/8"-M10x1-L600	G3/8	M10x1	600	19	10	PN 10 / 90°C	20/1	P-29	0,117	2902060	14,80 zł

2. VIPER PLUS - 1/2"

Wężyk do baterii z krótką końcówką

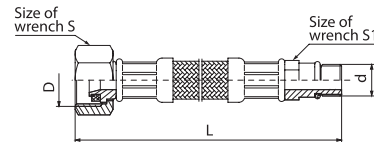

Kod	Wersja	Wymiary					P nom. / max temp.	Ilość szt.	Opakow.	Waga netto	Kod	Cena
		D	d	L	S	S1						
2902160	1/2"-M8x1-L350	G1/2	M8x1	350	23	10	PN 10 / 90°C	20/1	P-21	0,083	2902160	8,40 zł
2902170	1/2"-M8x1-L450	G1/2	M8x1	450	23	10	PN 10 / 90°C	20/1	P-28	0,096	2902170	9,10 zł
2902070	1/2"-M8x1-L500	G1/2	M8x1	500	23	10	PN 10 / 90°C	20/1	P-28	0,111	2902070	10,40 zł
2902080	1/2"-M8x1-L600	G1/2	M8x1	600	23	10	PN 10 / 90°C	20/1	P-29	0,127	2902080	12,90 zł
2902140	1/2"-M10x1-L350	G1/2	M10x1	350	23	10	PN 10 / 90°C	20/1	P-21	0,085	2902140	11,60 zł
2902150	1/2"-M10x1-L450	G1/2	M10x1	450	23	10	PN 10 / 90°C	20/1	P-28	0,097	2902150	13,10 zł
2902090	1/2"-M10x1-L500	G1/2	M10x1	500	23	10	PN 10 / 90°C	20/1	P-28	0,105	2902090	13,90 zł
2902100	1/2"-M10x1-L600	G1/2	M10x1	600	23	10	PN 10 / 90°C	20/1	P-29	0,119	2902100	17,10 zł

3. VIPER PLUS - 3/8"-3/8"

Wężyk z gwintem wewnętrznym

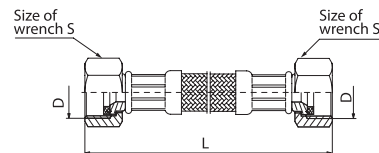

Kod	Wersja	Wymiary			P nom. / max temp.	Ilość szt.	Opakow.	Waga netto	Kod	Cena
		D	L	S						
2902310	3/8"-L200	G3/8	200	19	PN 10 / 90°C	20/1	P-22	0,066	2902310	9,80 zł
2902320	3/8"-L300	G3/8	300	19	PN 10 / 90°C	20/1	P-21	0,083	2902320	10,90 zł
2902330	3/8"-L400	G3/8	400	19	PN 10 / 90°C	20/1	P-28	0,097	2902330	11,60 zł
2902340	3/8"-L500	G3/8	500	19	PN 10 / 90°C	20/1	P-28	0,103	2902340	12,50 zł

4. VIPER PLUS - 1/2"-1/2"

Wężyk z gwintem wewnętrznym

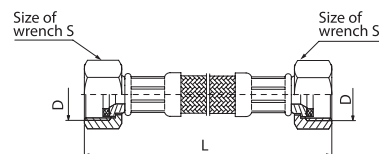

Kod	Wersja	Wymiary			P nom. / max temp.	Ilość szt.	Opakow.	Waga netto	Kod	Cena
		D	L	S						
2902350	1/2"-L200	G1/2	200	23	PN 10 / 90°C	20/1	P-22	0,078	2902350	11,40 zł
2902360	1/2"-L300	G1/2	300	23	PN 10 / 90°C	20/1	P-21	0,091	2902360	12,00 zł
2902370	1/2"-L400	G1/2	400	23	PN 10 / 90°C	20/1	P-28	0,011	2902370	13,10 zł
2902380	1/2"-L500	G1/2	500	23	PN 10 / 90°C	20/1	P-28	0,120	2902380	14,00 zł
2902390	1/2"-L600	G1/2	600	23	PN 10 / 90°C	20/1	P-29	0,137	2902390	15,20 zł
2902750	1/2"-L700	G1/2	700	23	PN 10 / 90°C	20/1	P-30	0,151	2902750	15,90 zł
2902760	1/2"-L800	G1/2	800	23	PN 10 / 90°C	20/1	P-30	0,167	2902760	16,50 zł
2902400	1/2"-L1000	G1/2	1000	23	PN 10 / 90°C	20/1	P-31	0,176	2902400	19,40 zł
2902770	1/2"-L1200	G1/2	1200	23	PN 10 / 90°C	20/1	P-16	0,229	2902770	19,70 zł
2902780	1/2"-L1500	G1/2	1500	23	PN 10 / 90°C	20/1	P-26	0,273	2902780	20,70 zł
2902790	1/2"-L2000	G1/2	2000	23	PN 10 / 90°C	20/1	P-24	0,346	2902790	26,70 zł

5. VIPER PLUS - 3/4"-3/4"

Wężyk z gwintem wewnętrznym

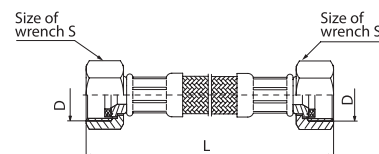

Kod	Wersja	Wymiary			P nom. / max temp.	Ilość szt.	Opakow.	Waga netto	Kod	Cena
		D	L	S						
2902800	3/4"-L300	G3/4	300	29	PN 10 / 90°C	20/1	P-28	0,144	2902800	17,90 zł
2902810	3/4"-L400	G3/4	400	29	PN 10 / 90°C	20/1	P-28	0,159	2902810	19,00 zł
2902410	3/4"-L500	G3/4	500	29	PN 10 / 90°C	20/1	P-30	0,174	2902410	24,20 zł
2902420	3/4"-L600	G3/4	600	29	PN 10 / 90°C	20/1	P-30	0,189	2902420	25,40 zł
2902430	3/4"-L800	G3/4	800	29	PN 10 / 90°C	20/1	P-9	0,222	2902430	30,90 zł

6. **VIPER PLUS - 1/2"-3/8"**
Wężyczek redukcyjny z gwintem wewnętrznym

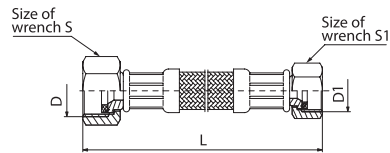

Kod	Wersja	Wymiary					P nom. / max temp.	Ilość szt.	Opakow.	Waga netto	Kod	Cena
		D	D1	L	S	S1						
2902510	1/2"-3/8"-L200	G1/2	G3/8	200	23	19	PN 10 / 90°C	20/1	P-22	0,070	2902510	10,30 zł
2902520	1/2"-3/8"-L300	G1/2	G3/8	300	23	19	PN 10 / 90°C	20/1	P-21	0,080	2902520	11,40 zł
2902530	1/2"-3/8"-L400	G1/2	G3/8	400	23	19	PN 10 / 90°C	20/1	P-28	0,101	2902530	12,30 zł
2902540	1/2"-3/8"-L500	G1/2	G3/8	500	23	19	PN 10 / 90°C	20/1	P-28	0,114	2902540	13,60 zł
2902500	1/2"-3/8"-L600	G1/2	G3/8	600	23	19	PN 10 / 90°C	20/1	P-29	0,130	2902500	14,30 zł
2902490	1/2"-3/8"-L800	G1/2	G3/8	800	23	19	PN 10 / 90°C	20/1	P-30	0,152	2902490	14,90 zł

7. **VIPER PLUS - 3/4"-1/2"**
Wężyczek redukcyjny z gwintem wewnętrznym

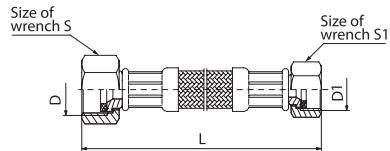

Kod	Wersja	Wymiary					P nom. / max temp.	Ilość szt.	Opakow.	Waga netto	Kod	Cena
		D	D1	L	S	S1						
2902550	3/4"-1/2"-L300	G3/4	G1/2	300	29	23	PN 10 / 90°C	20/1	P-28	0,117	2902550	17,50 zł
2902560	3/4"-1/2"-L400	G3/4	G1/2	400	29	23	PN 10 / 90°C	20/1	P-28	0,133	2902560	18,60 zł
2902570	3/4"-1/2"-L500	G3/4	G1/2	500	29	23	PN 10 / 90°C	20/1	P-29	0,145	2902570	19,50 zł

8. **VIPER PLUS - 1/2"-1/2"**
Wężyczek z gwintem wewnętrznym - zewnętrznym

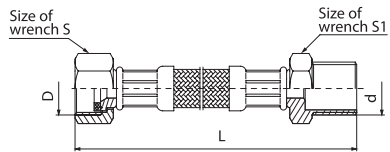
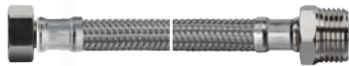

Kod	Wersja	Wymiary					P nom. / max temp.	Ilość szt.	Opakow.	Waga netto	Kod	Cena
		D	d	L	S	S1						
2902610	1/2"-1/2"-L300	G1/2	G1/2	300	23	21	PN 10 / 90°C	20/1	P-21	0,100	2902610	13,10 zł
2902620	1/2"-1/2"-L400	G1/2	G1/2	400	23	21	PN 10 / 90°C	20/1	P-28	0,116	2902620	13,20 zł
2902630	1/2"-1/2"-L500	G1/2	G1/2	500	23	21	PN 10 / 90°C	20/1	P-28	0,119	2902630	14,30 zł
2902640	1/2"-1/2"-L600	G1/2	G1/2	600	23	21	PN 10 / 90°C	20/1	P-29	0,146	2902640	15,90 zł
2902580	1/2"-1/2"-L700	G1/2	G1/2	700	23	21	PN 10 / 90°C	20/1	P-30	0,156	2902580	16,30 zł
2902590	1/2"-1/2"-L800	G1/2	G1/2	800	23	21	PN 10 / 90°C	20/1	P-30	0,171	2902590	17,10 zł
2902650	1/2"-1/2"-L1000	G1/2	G1/2	1000	23	21	PN 10 / 90°C	20/1	P-31	0,203	2902650	19,50 zł



1. 4TECH

Kurek kulowy pełnoprzelotowy do gazu z dźwignią stalową, wersja nakrętno-nakrętna

CE 1299

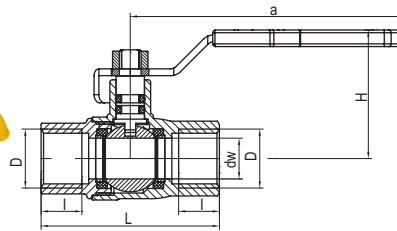

DN	Kod	Wymiar	Wymiary							P nom. / max temp.	Ilość szt.	Opakow.	Waga netto	Kod	Cena
			D	I	dw	L	a	H	S						
15	3402600	1/2"	Rp1/2	15	15	65,6	101,2	47,3	26	MOP 5-20 / T3	15	P-1	0,204	3402600	34,90 zł
20	3403600	3/4"	Rp3/4	16,3	20	72,6	101,2	51,3	31	MOP 5-20 / T3	10	P-1	0,314	3403600	50,60 zł
25	3404600	1"	Rp1	19,1	25	87	121,2	60,8	39	MOP 5-20 / T3	5	P-1	0,523	3404600	76,40 zł

2. ORION

Kurek kulowy pełnoprzelotowy do gazu z dźwignią stalową, wersja nakrętno-nakrętna

CE 1299

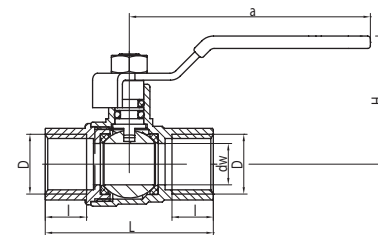

DN	Kod	Wymiar	Wymiary							P nom. / max temp.	Ilość szt.	Opakow.	Waga netto	Kod	Cena
			D	I	dw	L	a	H	S						
15	3412050	1/2"	Rp1/2	15	15	61	86,5	46,5		MOP 5-20 / T3	10	P-1	0,204	3412050	28,20 zł
20	3413050	3/4"	Rp3/4	16,3	20	69	86,5	55,5		MOP 5-20 / T3	6	P-1	0,314	3413050	41,30 zł
25	3414050	1"	Rp1	19,1	25	82	100	60		MOP 5-20 / T3	6	P-1	0,523	3414050	60,30 zł
32	3415030	1" 1/4"	Rp1 1/4	21,4	32	95	150	75		MOP 5-20 / T3	2	P-1	0,874	3415030	103,40 zł
40	3406030	1" 1/2"	Rp1 1/2	21,4	40	105	150	81		MOP 5-20 / T3	4	P-1	1,203	3406030	143,30 zł
50	3407030	2"	Rp2	25,7	50	127	150	91		MOP 5-20 / T3	2	P-1	1,993	3407030	222,40 zł

3. ORION

Kurek kulowy pełnoprzelotowy do gazu z motykiem aluminiowym (MAI), wersja nakrętno-nakrętna

CE 1299

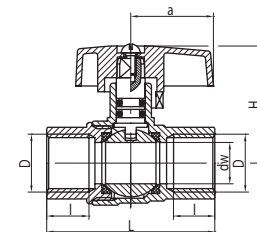

DN	Kod	Wymiar	Wymiary							P nom. / max temp.	Ilość szt.	Opakow.	Waga netto	Kod	Cena
			D	I	dw	L	a	H	S						
15	3412070	1/2"	Rp1/2	15	15	61	30	43		MOP 5-20 / T3	10	P-1	0,197	3412070	28,20 zł
20	3413070	3/4"	Rp3/4	16,3	20	69	30	47		MOP 5-20 / T3	6	P-1	0,300	3413070	41,30 zł
25	3414070	1"	Rp1	19,1	25	82	40	57		MOP 5-20 / T3	6	P-1	0,512	3414070	60,30 zł

4. ORION

Kurek kulowy pełnoprzelotowy do gazu z dźwignią stalową, wersja nakrętno-wkrętna

CE 1299

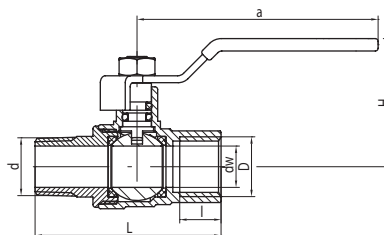

DN	Kod	Wymiar	Wymiary							P nom. / max temp.	Ilość szt.	Opakow.	Waga netto	Kod	Cena
			D	I	dw	L	a	H	d						
15	3412090	1/2"	Rp1/2	15	15	67,5	86,5	46,5	R1/2	MOP 5-20 / T3	10	P-1	0,205	3412090	31,20 zł
20	3413090	3/4"	Rp3/4	16,3	20	75,5	86,5	50,5	R3/4	MOP 5-20 / T3	6	P-1	0,319	3413090	46,20 zł
25	3414090	1"	Rp1	19,1	25	87,5	103	60	R1	MOP 5-20 / T3	6	P-1	0,526	3414090	64,20 zł

5. ORION

Kurek kulowy pełnoprzelotowy do gazu z motykiem aluminiowym (MAI), wersja nakrętno-wkrętna

CE 1299

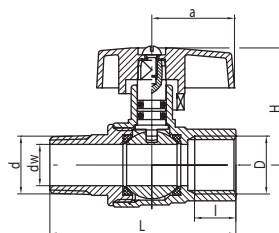

DN	Kod	Wymiar	Wymiary							P nom. / max temp.	Ilość szt.	Opakow.	Waga netto	Kod	Cena
			D	I	dw	L	a	H	d						
15	3412150	1/2"	Rp1/2	15	15	67,5	30	43	R1/2	MOP 5-20, T3	10	P-1	0,198	3412150	31,20 zł
20	3413150	3/4"	Rp3/4	16,3	20	75,5	30	47	R3/4	MOP 5-20, T3	6	P-1	0,309	3413150	46,20 zł
25	3414150	1"	Rp1	19,1	25	87,5	40	57	R1	MOP 5-20, T3	6	P-1	0,507	3414150	64,20 zł

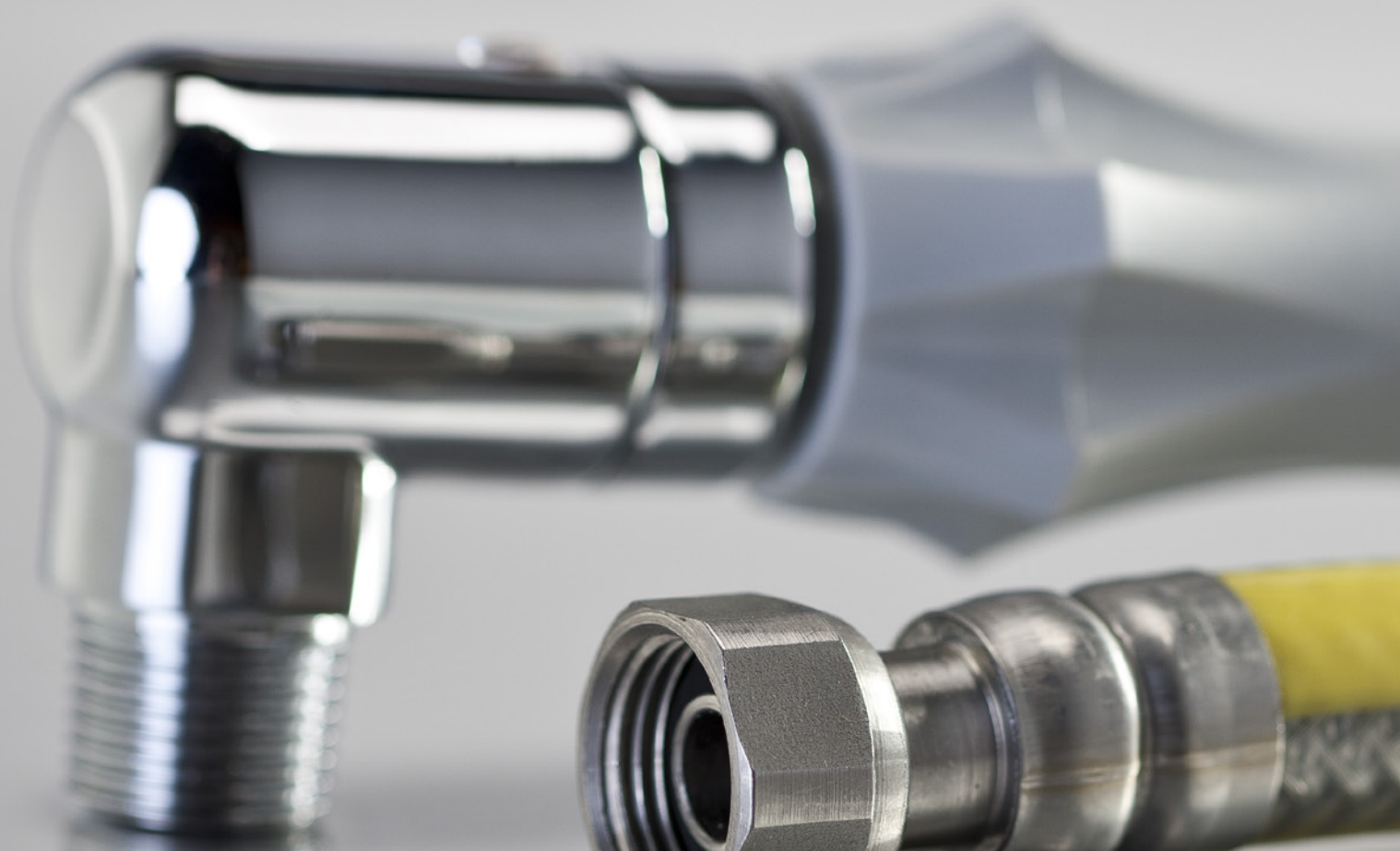

6. V-GAS
Filtr do gazu śrutowany

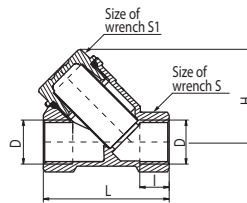

DN	Kod	Wymiary							P nom. / max temp.	Ilość szt.	Opakow.	Waga netto	Kod	Cena
		Wymiar	D	L	I	H	S	S1						
15	3900100	1/2"	Rp1/2	64	15	44	26	26	MOP 5, T4	12	P-1	0,214	3900100	29,90 zł
20	3900200	3/4"	Rp3/4	77	16,3	51,5	32	27	MOP 5, T4	8	P-1	0,371	3900200	44,00 zł
25	3900300	1"	Rp1	92,5	19,1	59,5	41	30	MOP 5, T4	5	P-1	0,593	3900300	70,50 zł

7. V-GAS
Szybkozłącze do gazu kompletne z przewodem w osłonie PCV

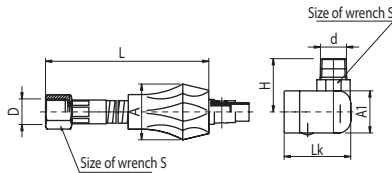

Kod	Dimension									P nom.	Ilość szt.	Opakow.	Waga netto	Kod	Cena
	Wymiar	D	d	L	Lk	A	A1	H	S						
3901600	L=500	Rp1/2	R1/2	500	54,5	46	34	43	24	MOP 0,5	5/1	P-29	0,644	3901600	146,00 zł
3901610	L=750	Rp1/2	R1/2	750	54,5	46	34	43	24	MOP 0,5	5/1	P-31	0,739	3901610	158,50 zł
3901620	L=1000	Rp1/2	R1/2	1000	54,5	46	34	43	24	MOP 0,5	5/1	P-33	0,829	3901620	169,50 zł
3901630	L=1250	Rp1/2	R1/2	1250	54,5	46	34	43	24	MOP 0,5	5/1	P-33	0,908	3901630	185,00 zł
3901640	L=1500	Rp1/2	R1/2	1500	54,5	46	34	43	24	MOP 0,5	5/1	P-33	1,010	3901640	197,00 zł
3901650	L=2000	Rp1/2	R1/2	2000	54,5	46	34	43	24	MOP 0,5	3/1	P-33	1,192	3901650	243,00 zł

8. V-GAS
Przewód elastyczny do gazu w osłonie PCV z obrotową nakrętką

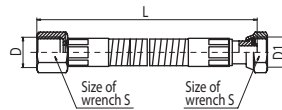

Kod	Dimension					P nom.	Ilość szt.	Opakow.	Waga netto	Kod	Cena
	Wymiar	D	D1	L	S						
3901500	L=500	Rp1/2	G1/2	500	24	MOP 0,5	10/1	P-33	0,270	3901500	70,50 zł
3901510	L=750	Rp1/2	G1/2	750	24	MOP 0,5	10/1	P-33	0,361	3901510	78,00 zł
3901520	L=1000	Rp1/2	G1/2	1000	24	MOP 0,5	5/1	P-33	0,450	3901520	85,50 zł
3901530	L=1250	Rp1/2	G1/2	1250	24	MOP 0,5	5/1	P-33	0,544	3901530	94,00 zł
3901540	L=1500	Rp1/2	G1/2	1500	24	MOP 0,5	5/1	P-33	0,640	3901540	105,00 zł
3901700	L=2000	Rp1/2	G1/2	2000	24	MOP 0,5	3/1	P-33	0,850	3901700	118,00 zł

9. V-GAS
Przewód elastyczny do gazu V-GAS w osłonie PCV 1/2" ze złączką kolankową z obrotowymi nakrętkami

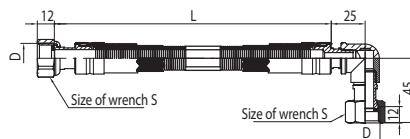
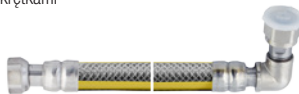

Kod	Dimension				P nom.	Ilość szt.	Opakow.	Waga netto	Kod	Cena
	Wymiar	D	L	S						
3901750	L=500	G1/2	500	24	MOP 0,5	10/1	P-33	0,320	3901750	86,10 zł
3901760	L=750	G1/2	750	24	MOP 0,5	10/1	P-33	0,390	3901760	96,60 zł
3901770	L=1000	G1/2	1000	24	MOP 0,5	5/1	P-33	0,470	3901770	106,00 zł
3901780	L=1250	G1/2	1250	24	MOP 0,5	5/1	P-33	0,530	3901780	116,50 zł
3901790	L=1500	G1/2	1500	24	MOP 0,5	5/1	P-33	0,610	3901790	126,00 zł
3901800	L=2000	G1/2	2000	24	MOP 0,5	3/1	P-33	0,740	3901800	141,50 zł

ARMATURA INSTALACYJNA GAZOWA

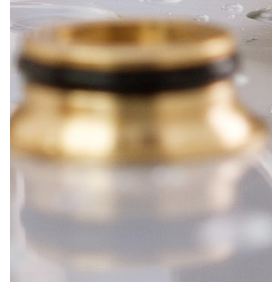
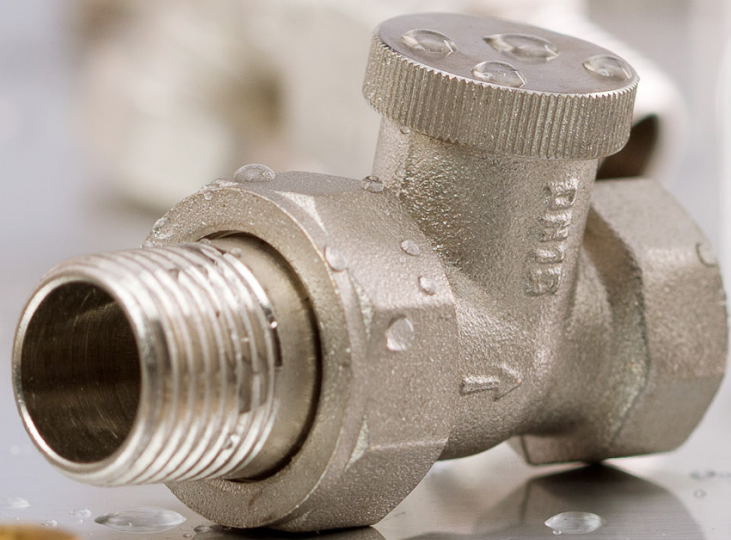

1. THERMO

Głowica termostaticzna typ GZ.08A



GŁOWICA	GZ08A
zawór VECTOR	
zawór IRIS	X
przyłącze M30x1,5 (typ Heimeier)	X
Danfoss z przyłączem RA - w przypadku grzejników z wkładką typu DANFOSS należy zastosować adapter - 4445110	

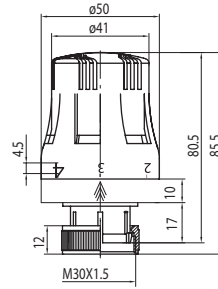

Kod	Wersja	Ilość szt.	Opakow.	Waga netto	Kod	Cena
4445050	7÷28°C	30/1	P-42	0.123	4445050	32,50 zł

2. IRIS

Głowica termostaticzna typ GZ.07A



GŁOWICA	GZ07A
zawór VECTOR	
zawór IRIS	X
przyłącze M30x1,5 (typ Heimeier)	X
Danfoss z przyłączem RA - w przypadku grzejników z wkładką typu DANFOSS należy zastosować adapter - 4445110	X

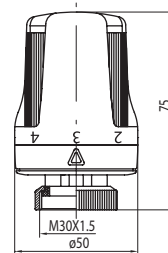

Kod	Wersja	Ilość szt.	Opakow.	Waga netto	Kod	Cena
4445000	GZ.07A 6÷29°C	50/1	P-85/P-11f	0,120	4445000	54,00 zł

3. FUSION

Głowica termostaticzna typ GZ.05A



GŁOWICA	GZ05A
zawór VECTOR	
zawór IRIS	X
przyłącze M30x1,5 (typ Heimeier)	X
Danfoss z przyłączem RA - w przypadku grzejników z wkładką typu DANFOSS należy zastosować adapter - 4445110	

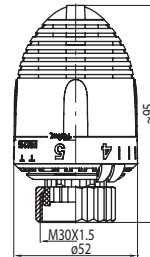

Kod	Wersja	Ilość szt.	Opakow.	Waga netto	Kod	Cena
4440010	GZ.05A 6÷28°C	30/1	P-42 / P-11c	0,130	4440010	39,90 zł
4440300	GZ.05A 6÷28°C with blockade	30/1	P-42 / P-11c	0,131	4440300	42,00 zł
4440410	GZ.05A 16÷28°C	30/1	P-42 / P-11c	0,130	4440410	43,00 zł
4440430	GZ.05A 16÷28°C with blockade	30/1	P-42 / P-11c	0,131	4440430	44,50 zł

4. VELA

Głowica termostaticzna typ GZ.03A



GŁOWICA	GZ03A
zawór VECTOR	
zawór IRIS	X
przyłącze M30x1,5 (typ Heimeier)	X
Danfoss z przyłączem RA - w przypadku grzejników z wkładką typu DANFOSS należy zastosować adapter - 4445110	

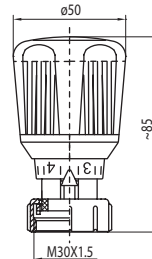

Kod	Wersja	Ilość szt.	Opakow.	Waga netto	Kod	Cena
4410090	GZ.03A 6÷30°C	30/1	P-42 / P-11	0,132	4410090	38,90 zł

5. IRIS

Zawór termostaticzny prosty, niklowany



GŁOWICA	IRIS
GZ.08A	X
GZ.07A	X
GZ.05A	X
GZ.03A	X
GZ.05	
GZ.03	

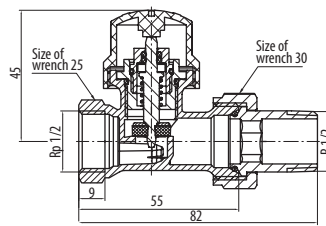

Kod	Kolor	Wymiar	P nom.	Ilość szt.	Opakow.	Waga netto	Kod	Cena
4445510	NIKLOWANY	1/2"	PN 10	100/25/1	P-136/P-12a	0,235	4445510	41,00 zł
4445530	BIAŁY	1/2"	PN 10	100/25/1	P-136/P-12a	0,235	4445530	53,00 zł

6. IRIS
Zawór termostatyczny kątowy, nikielowany



GŁÓWICA	IRIS
GZ.08A	X
GZ.07A	X
GZ.05A	X
GZ.03A	X
GZ.05	
GZ.03	

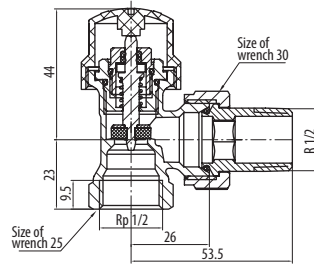

Kod	Kolor	Wymiar	P nom.	Ilość szt.	Opakow.	Waga netto	Kod	Cena
4445610	NIKLÓWANY	1/2"	PN 10	100/25/1	P-136/P-12a	0,235	4445610	41,00 zł
4445630	BIAŁY	1/2"	PN 10	100/25/1	P-136/P-12a	0,235	4445630	53,00 zł

7. VECTOR
Głowica termostatyczna typ GZ.05



GŁÓWICA	GZ05
zawór VECTOR	X
zawór IRIS	
przyłącze M30x1,5 (typ Heimeier)	
Danfoss z przyłączem RA	
- w przypadku grzejników	
z wkładką typu DANFOSS należy	
zastosować adapter - 4445110	

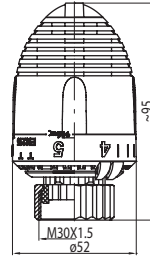

Kod	Wersja	Ilość szt.	Opakow.	Waga netto	Kod	Cena
4440000	GZ.05 6÷28°C	30/1	P-42 / P-11b	0,137	4440000	39,90 zł
4440020	GZ.05 6÷28°C z blokadą	30/1	P-42 / P-11b	0,138	4440020	42,00 zł
4440400	GZ.05 16÷28°C	30/1	P-42 / P-11b	0,138	4440400	43,00 zł
4440420	GZ.05 16÷28°C z blokadą	30/1	P-42 / P-11b	0,139	4440420	44,50 zł

8. VIRGO
Głowica termostatyczna typ GZ.03



GŁÓWICA	GZ03
zawór VECTOR	X
zawór IRIS	
przyłącze M30x1,5 (typ Heimeier)	
Danfoss z przyłączem RA	
- w przypadku grzejników	
z wkładką typu DANFOSS należy	
zastosować adapter - 4445110	

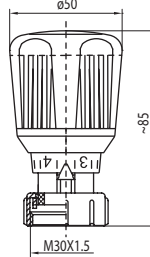

Kod	Wersja	Ilość szt.	Opakow.	Waga netto	Kod	Cena
4410000	GZ.03 6÷30°C	30/1	P-42 / P-11	0,131	4410000	38,90 zł

9. VECTOR
Zawór termostatyczny prosty ZT22 nikielowany z ruchomą przylusną (z nastawą wstępną)



GŁÓWICA	VECTOR
GZ.08A	
GZ.07A	
GZ.05A	
GZ.03A	
GZ.05	X
GZ.03	X

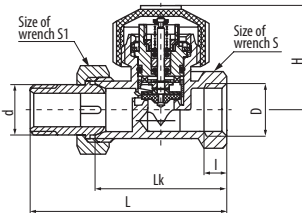

DN	Kod	Kolor	Wymiary										P nom.	Ilość szt.	Opakow.	Waga netto	Kod	Cena
			Wymiar	D	d	L	Lk	I	H	S	S1	S2						
FP 10	4411010	NIKLÓWANY	3/8"	Rp3/8	R3/8	75	50	9	41,5	22	27	PN 10	30/1	P-25 / P-12	0,228	4411010	47,00 zł	
FP 15	4412010	NIKLÓWANY	1/2"	Rp1/2	R1/2	82	55	10	41,5	27	30	PN 10	30/1	P-25 / P-12	0,271	4412010	49,90 zł	
FP 20	4413010	NIKLÓWANY	3/4"	Rp3/4	R3/4	98	65	12	43	32	37	PN 10	30/1	P-25 / P-12	0,352	4413010	59,90 zł	
FP 15	4412090	BIAŁY	1/2"	Rp1/2	R1/2	82	55	10	41,5	27	30	PN 10	30/1	P-25 / P-12	0,271	4412090	65,00 zł	

10. VECTOR
Zawór termostatyczny kątowy ZT22 nikielowany z ruchomą przylusną (z nastawą wstępną)



GŁÓWICA	VECTOR
GZ.08A	
GZ.07A	
GZ.05A	
GZ.03A	
GZ.05	X
GZ.03	X

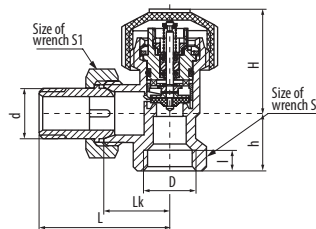

DN	Kod	Kolor	Wymiary										P nom.	Ilość szt.	Opakow.	Waga netto	Kod	Cena
			Wymiar	D	d	L	Lk	I	H	h	S	S1						
FK 15	4512010	NIKLÓWANY	1/2"	Rp1/2	R1/2	53	26	10	41,5	23	27	PN 10	30/1	P-25 / P-12	0,253	4512010	49,90 zł	
FK 20	4513010	NIKLÓWANY	3/4"	Rp3/4	R3/4	63	30	12	43	26	32	PN 10	30/1	P-25 / P-12	0,326	4513010	59,90 zł	
FK 15	4512090	BIAŁY	1/2"	Rp1/2	R1/2	53	26	10	41,5	23	27	PN 10	30/1	P-25 / P-12	0,253	4512090	65,00 zł	

11. VECTOR

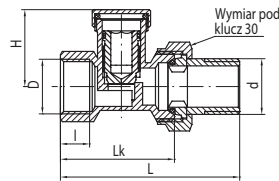
Zawór grzejnikowy odcinający prosty
ZO-P-15 nikielowany

DN	Kod	Kolor	Wymiary								P nom.	Ilość szt.	Opakow.	Waga netto	Kod	Cena
			Wymiar	D	d	L	Lk	I	H	S						
10	4420020	NICKEL	3/8"	Rp3/8	R3/8	64,5	43	10	29	24	PN 10	80/10	P-43	0,128	4420020	17,40 zł
15	4420080	NICKEL	1/2"	Rp1/2	R1/2	67,5	43	11	29	30	PN 10	80/10	P-43	0,160	4420080	20,50 zł
20	4420300	WHITE	1/2"	Rp1/2	R1/2	67,5	43	11	29	30	PN 10	80/10	P-43	0,160	4420300	26,50 zł

12. VECTOR

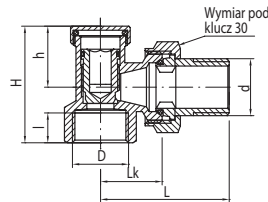
Zawór grzejnikowy odcinający kątowy
ZO-K-15 nikielowany

DN	Kod	Kolor	Wymiary								P nom.	Ilość szt.	Opakow.	Waga netto	Kod	Cena	
			Wymiar	D	d	L	Lk	I	H	S							
10	4520020	NICKEL	3/8"	Rp3/8	R3/8	64,5	43	10	40,5	24	22,5	PN 10	80/10	P-43	0,128	4520020	17,40 zł
15	4520080	NICKEL	1/2"	Rp1/2	R1/2	67,5	48	11	43	30	22,5	PN 10	80/10	P-43	0,150	4520080	20,50 zł
20	4520300	WHITE	1/2"	Rp1/2	R1/2	67,5	48	11	43	30	22,5	PN 10	80/10	P-43	0,150	4520300	26,50 zł

13. THERMO SET

Zestaw termostatyczny prosty,
nikielowany

Kod	Wymiar	P nom.	Ilość szt.	Opakow.	Waga netto	Kod	Cena
4445200	1/2"	PN 10	20/1	P-4445.20/2 / P-4445.20/1	0,513	4445200	85,40 zł

14. THERMO SET

Zestaw termostatyczny kątowy,
nikielowany

Kod	Wymiar	P nom.	Ilość szt.	Opakow.	Waga netto	Kod	Cena
4445250	1/2"	PN 10	20/1	P-4445.20/2 / P-4445.25/1	0,492	4445250	85,40 zł

15. VECTOR MAX

Zestaw termostatyczny prosty duży,
nikielowany

Rys. techn.:

- poz. 7
- poz. 9
- poz. 11

Kod	Wymiar	P nom.	Ilość szt.	Opakow.	Waga netto	Kod	Cena
4412500	1/2"	PN 10	24/1	P-87 / P-set	0,563	4412500	106,00 zł

16. VECTOR MAX

Zestaw termostatyczny kątowy duży,
nikielowany

Rys. techn.:

- poz. 7
- poz. 10
- poz. 12

Kod	Wymiar	P nom.	Ilość szt.	Opakow.	Waga netto	Kod	Cena
4512500	1/2"	PN 10	24/1	P-87 / P-set	0,537	4512500	106,00 zł

17. THERMO PLUS

Zestaw termostatyczny prosty duży z 2 przyłączkami G 1/2 / 3/4, niklowany



Rys. techn.:

- poz. 1
- poz. 25

Kod	Wymiar	P nom. / T max	Ilość szt.	Opakow.	Waga netto	Kod	Cena
4445100	GZ3/4-GW3/4	PN 10 / 100°C	24/1	P-87	0,513	4445100	88,50 zł

18. THERMO PLUS

Zestaw termostatyczny kątowy duży z 2 przyłączkami G 1/2 / 3/4, niklowany



Rys. techn.:

- poz. 1
- poz. 26

Kod	Wymiar	P nom. / T max	Ilość szt.	Opakow.	Waga netto	Kod	Cena
4445150	GZ3/4-GW3/4	PN 10 / 100°C	24/1	P-87	0,492	4445150	88,50 zł

19. THERMO SET

Zestaw termostatyczny prosty, niklowany



Rys. techn.:

- poz. 1
- poz. 27

Kod	Wymiar	P nom. / T max	Ilość szt.	Opakow.	Waga netto	Kod	Cena
4445300	GZ3/4-GW3/4	PN 10 / 100°C	20/1	P-4445.20/2 / P-4445.30/1	0,482	4445300	77,00 zł

20. THERMO SET

Zestaw termostatyczny kątowy, niklowany



Rys. techn.:

- poz. 1
- poz. 28

Kod	Wymiar	P nom. / T max	Ilość szt.	Opakow.	Waga netto	Kod	Cena
4445350	GZ3/4-GW3/4	PN 10 / 100°C	20/1	P-4445.20/2 / P-4445.35/1	0,485	4445350	77,00 zł

21. FUSION

Zespół odcinający prosty do grzejników kompaktowych z 2 tulejkami pośrednimi niklowany

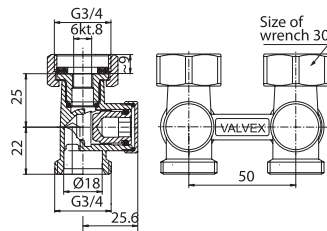

Kod	Wymiar	P nom. / T max	Ilość szt.	Opakow.	Waga netto	Kod	Cena
1480010	GZ3/4-GW3/4	PN 10 / 100°C	10	P-22	0,359	1480010	48,00 zł

22. FUSION

Zespół odcinający prosty do grzejników kompaktowych z 2 przyłączkami G 1/2 / 3/4 niklowany

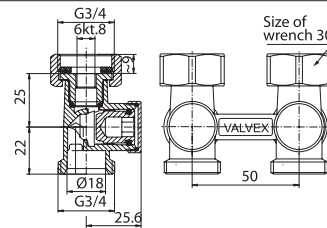

Kod	Wymiar	P nom. / T max	Ilość szt.	Opakow.	Waga netto	Kod	Cena
1480030	GZ3/4-GW3/4	PN 10 / 100°C	10	P-21	0,405	1480030	56,00 zł

23. FUSION

Zespół odcinający kątowy do grzejników kompaktowych z 2 tulejkami pośrednimi niklowanymi

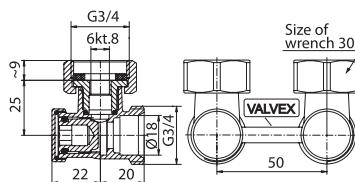

Kod	Wymiar	P nom. / T max	Ilość szt.	Opakow.	Waga netto	Kod	Cena
1480050	GZ3/4-GW3/4	PN 10 / 100°C	10	P-22	0,312	1480050	48,00 zł

24. FUSION

Zespół odcinający kątowy do grzejników kompaktowych z 2 przyłączkami G 1/2 / 3/4

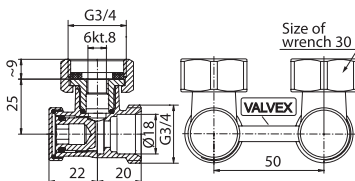

Kod	Wymiar	P nom. / T max	Ilość szt.	Opakow.	Waga netto	Kod	Cena
1480070	GZ3/4-GW3/4	PN 10 / 100°C	10	P-21	0,361	1480070	56,00 zł

25. FUSION 3

Zespół odcinający prosty do grzejników kompaktowych z 2 przyłączkami G 1/2 / 3/4 niklowany

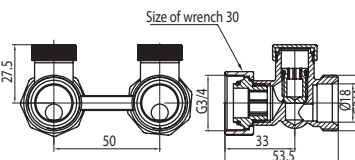

Kod	Wymiar	P nom. / T max	Ilość szt.	Opakow.	Waga netto	Kod	Cena
4412750	GZ3/4-GW3/4	PN 10 / 100°C	10/1	P-21	0,405	4412750	53,70 zł

26. FUSION 3

Zespół odcinający kątowy do grzejników kompaktowych z 2 przyłączkami G 1/2 / 3/4

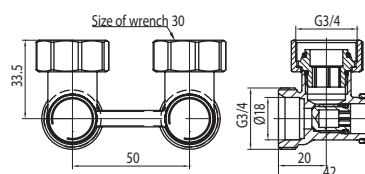

Kod	Wymiar	P nom. / T max	Ilość szt.	Opakow.	Waga netto	Kod	Cena
4512750	GZ3/4-GW3/4	PN 10 / 100°C	10/1	P-21	0,361	4512750	48,30 zł

27. FUSION 3

Zespół odcinający prosty do grzejników kompaktowych

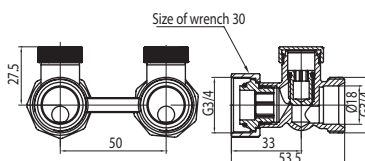

Kod	Wymiar	P nom. / T max	Ilość szt.	Opakow.	Waga netto	Kod	Cena
1480500	GZ3/4-GW3/4	PN 10 / 100°C	10	P-21	0,359	1480500	44,60 zł

28. FUSION 3

Zespół odcinający kątowy do grzejników kompaktowych

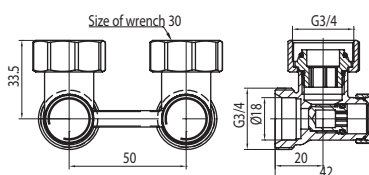

Kod	Wymiar	P nom. / T max	Ilość szt.	Opakow.	Waga netto	Kod	Cena
1480600	GZ3/4-GW3/4	PN 10 / 100°C	10	P-21	0,361	1480600	40,30 zł

29. FUSION

Tulejka

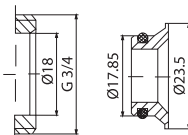

Kod	Ilość szt.	Opakow.	Waga netto	Kod	Cena
1481770	640/20	P-10 / P-14	0,010	1481770	3,29 zł

30. FUSION

Przyłączka G1/2-G3/4 niklowana

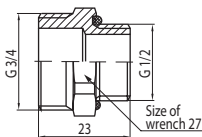

Kod	Wymiar	Ilość szt.	Opakow.	Waga netto	Kod	Cena
1481790	1/2"/3/4"	320/10	P-10 / P-14	0,051	1481790	8,79 zł

31. FUSION 3

Przyłączka G1/2-G3/4 niklowana

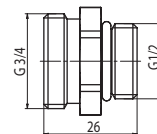

Kod	Wymiar	Ilość szt.	Opakow.	Waga netto	Kod	Cena
6097060	1/2"/3/4"	320/10	P-10 / P-14	0,051	6097060	6,35 zł

32. VECTOR LUX

Termolux TRG-2 G3/4" niklowany

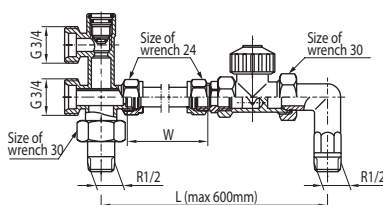

Kod	Wymiar	P nom. / T max	Ilość szt.	Opakow.	Waga netto	Kod	Cena
4400030	TRG-2 G3/4"	PN 10 / 120°C	8	P-9	0,908	4400030	245,00 zł

33. IRIS

Adapter (do głowicy IRIS GZ.07A)

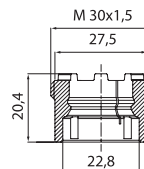

Kod	Ilość szt.	Opakow.	Waga netto	Kod	Cena
4445110	150/10	P-1 / foil bag 120x180	0,006	4445110	3,00 zł

34. ACTIV PLUS

Zawór grzejnikowy prosty zasilający niklowany

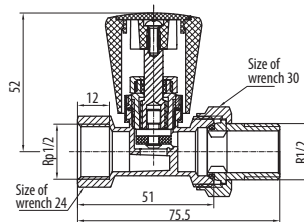

Kod	Kolor	Wymiar	P nom. / T max	Ilość szt.	Opakow.	Waga netto	Kod	Cena
4482070	NIKLOWANY	1/2"	PN 10 / 100°C	100/10	P-4482.07/2 / P-4482.07/1	0,186	4482070	26,40 zł
4482080	BIAŁY	1/2"	PN 10 / 100°C	100/10	P-4482.07/2 / P-4482.07/1	0,186	4482080	34,00 zł

35. ACTIV PLUS

Zawór grzejnikowy kątowy zasilający niklowany

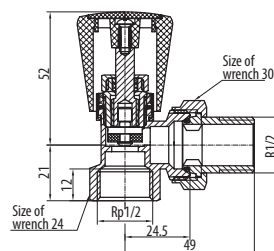

Kod	Kolor	Wymiar	P nom. / T max	Ilość szt.	Opakow.	Waga netto	Kod	Cena
4582070	NIKLOWANY	1/2"	PN 10 / 100°C	100/10	P-4482.07/2 / P-4482.07/1	0,174	4582070	26,40 zł
4582080	BIAŁY	1/2"	PN 10 / 100°C	100/10	P-4482.07/2 / P-4482.07/1	0,174	4582080	34,00 zł

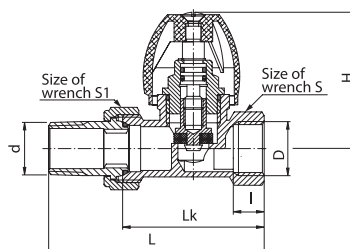
36. **ACTIV**Zawór grzejnikowy prosty zasilający
niklowany

DN	Kod	Kolor	Wymiar	Wymiary								P nom. / T max	Ilość szt.	Opakow.	Waga netto	Kod	Cena
10	4481050	NIKLOWANY	3/8"	Rp3/8	R3/8	75	50	10	51	22	26	PN 10 / 100°C	20	P-43	0,198	4481050	31,00 zł
15	4482050	NIKLOWANY	1/2"	Rp1/2	R1/2	82	55	12	52	26	30	PN 10 / 100°C	25	P-1	0,238	4482050	31,30 zł
20	4483050	NIKLOWANY	3/4"	Rp3/4	R3/4	96,5	65	12	53	32	37	PN 10 / 100°C	10	P-43	0,321	4483050	46,60 zł
15	4482250	BIAŁY	1/2"	Rp1/2	R1/2	82	55	12	52	26	30	PN 10 / 100°C	25	P-1	0,238	4482250	40,00 zł

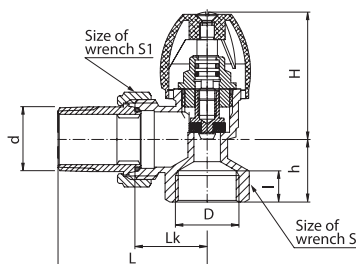
37. **ACTIV**Zawór grzejnikowy kątowy zasilający
niklowany

DN	Kod	Kolor	Wymiar	Wymiary								P nom. / T max	Ilość szt.	Opakow.	Waga netto	Kod	Cena
10	4581050	NIKLOWANY	3/8"	Rp3/8	R3/8	49	24	10	51	20	22	PN 10 / 100°C	20	P-43	0,192	4581050	25,30 zł
15	4582050	NIKLOWANY	1/2"	Rp1/2	R1/2	53	26	12	52	23	26	PN 10 / 100°C	25	P-1	0,219	4582050	31,30 zł
20	4583050	NIKLOWANY	3/4"	Rp3/4	R3/4	63	31,5	12	52	26	32	PN 10 / 100°C	10	P-43	0,301	4583050	50,60 zł
15	4582250	BIAŁY	1/2"	Rp1/2	R1/2	53	26	12	52	23	26	PN 10 / 100°C	25	P-1	0,219	4582250	40,00 zł

38. **ACTIV PLUS**

Zestaw grzejnikowy tradycyjny prosty



Rys. techn.:

- poz. 34
- poz. 11



Kod	Kolor	Wymiar	P nom. / T max	Ilość szt.	Opakow.	Waga netto	Kod	Cena
4412680	NIKLOWANY	1/2"	PN 10 / 100°C	20/1	P-42 / EN 56x145	0,346	4412680	45,00 zł
4412690	BIAŁY	1/2"	PN 10 / 100°C	40/1	P-4412.69 / Blister 4412.69	0,346	4412690	58,20 zł

39. **ACTIV PLUS**Zestaw grzejnikowy tradycyjny
kątowy

Rys. techn.:

- poz. 35
- poz. 12



Kod	Kolor	Wymiar	P nom. / T max	Ilość szt.	Opakow.	Waga netto	Kod	Cena
4512680	NIKLOWANY	1/2"	PN 10 / 100°C	20/1	P-42 / EN 56x145	0,324	4512680	45,90 zł
4512690	BIAŁY	1/2"	PN 10 / 100°C	40/1	P-4412.69 / Blister 4412.69	0,324	4512690	59,40 zł

40. ACTIV

Zestaw grzejnikowy tradycyjny prosty, niklowany



Rys. techn.:

- poz. 36
- poz. 11

Kod	Wymiar	P nom. / T max	Ilość szt.	Opakow.	Waga netto	Kod	Cena
4412580	1/2"	PN 10 / 100°C	20/1	P-42 / EN 56x145	0,401	4412580	50,40 zł

41. ACTIV

Zestaw grzejnikowy tradycyjny kątowy, niklowany



Rys. techn.:

- poz. 37
- poz. 12

Kod	Wymiar	P nom. / T max	Ilość szt.	Opakow.	Waga netto	Kod	Cena
4512580	1/2"	PN 10 / 100°C	20/1	P-42 / EN 56x145	0,373	4512580	50,40 zł

42. ALFA

Automatyczny zawór odpowietrzający z zaworem odcinającym

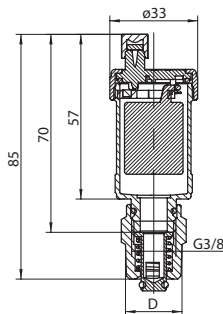

Kod	Kolor	Wymiar - D	P nom. / T max	Ilość szt.	Opakow.	Waga netto	Kod	Cena
4700360	ŚRUTOWANY	1/2"	PN 10 / 110°C	40/1	P-1 / P-19	0,137	4700360	29,90 zł
4700160	ŚRUTOWANY	3/8"	PN 10 / 110°C	40/1	P-1 / P-19	0,137	4700160	29,90 zł
4700330	NIKLOWANY	1/2"	PN 10 / 110°C	40/1	P-1 / P-19	0,137	4700330	32,50 zł
4700170	NIKLOWANY	3/8"	PN 10 / 110°C	40/1	P-1 / P-19	0,137	4700170	32,50 zł
4700230	BIAŁY	1/2"	PN 10 / 110°C	40/1	P-1 / P-19	0,137	4700230	37,50 zł

43. BETA

Zawór odpowietrzający niklowany

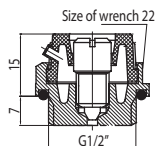

Kod	Wymiar	P nom. / T max	Ilość szt.	Opakow.	Waga netto	Kod	Cena
4700200	P-G1/2"	PN 10 / 100°C	240/30/10	P-1 / P-14	0,019	4700200	3,50 zł

44. GAMMA

Zawór odpowietrzający kątowy

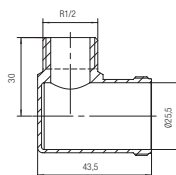

Kod	Wymiar	P nom. / T max	Ilość szt.	Opakow.	Waga netto	Kod	Cena
4700740	P-G1/2"	PN 10 / 110°C	40/1	P-1 / P-K38	0,099	4700740	20,00 zł

45. PIZA
Filtr skośny do wody miedziany

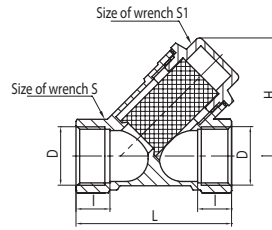

DN	Kod	Wymiary								P nom. / T max	Ilość szt.	Opakow.	Waga netto	Kod	Cena
		Wymiar	D	L	I	H	S	S1							
15	4990000	1/2"	G1/2	55	12	40	25	20	PN 25 / 110°C	90/15	P-43	0,144	4990000	17,30 zł	
20	4990010	3/4"	G3/4	66	12	50	30	23	PN 25 / 110°C	60/10	P-1	0,205	4990010	26,90 zł	
25	4990020	1"	G1	74	12	52	37	23	PN 25 / 110°C	48/8	P-1	0,296	4990020	39,20 zł	
32	4990030	1 1/4"	G1 1/4	94.5	14	63	48	32	PN 25 / 110°C	5	P-1	0,569	4990030	73,80 zł	
40	4990040	1 1/2"	G1 1/2	100	15	72	55	38	PN 25 / 110°C	3	P-1	0,793	4990040	97,50 zł	
50	4990050	2"	G2	113	15	88	68	45	PN 25 / 110°C	2	P-1	1,292	4990050	167,80 zł	

46. PROFF
Belka rozdzielacza

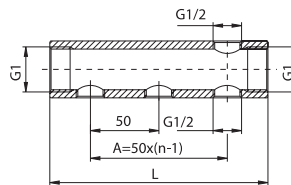

Kod	Wymiary				P nom. / T max	Ilość szt.	Opakow.	Waga netto	Kod	Cena
	Wymiar	n	A	L						
6087500	G1-G1/2	2	50	100	PN 10 / 95°C	32	P-6086.03	0.330	6087500	38,00 zł
6087510	G1-G1/2	3	100	150	PN 10 / 95°C	20	P-6086.03	0.512	6087510	56,00 zł
6087520	G1-G1/2	4	150	200	PN 10 / 95°C	16	P-6086.03	0.697	6087520	73,90 zł
6087530	G1-G1/2	5	200	250	PN 10 / 95°C	22	P-6086.06	0.888	6087530	92,00 zł
6087540	G1-G1/2	6	250	300	PN 10 / 95°C	18	P-6086.06	1.074	6087540	111,00 zł
6087550	G1-G1/2	7	300	350	PN 10 / 95°C	16	P-6086.06	1.244	6087550	131,50 zł
6087560	G1-G1/2	8	350	400	PN 10 / 95°C	16	P-6086.09	1.440	6087560	151,00 zł
6087570	G1-G1/2	9	400	450	PN 10 / 95°C	16	P-6086.09	1.621	6087570	176,00 zł
6087580	G1-G1/2	10	450	500	PN 10 / 95°C	16	P-6086.09	1.807	6087580	199,90 zł
6087590	G1-G1/2	11	500	550	PN 10 / 95°C	16	P-6086.11	1.984	6087590	213,00 zł
6087600	G1-G1/2	12	550	600	PN 10 / 95°C	16	P-6086.11	2.173	6087600	242,00 zł

47. PROFF
Zespół rozdzielaczy PROFF K1

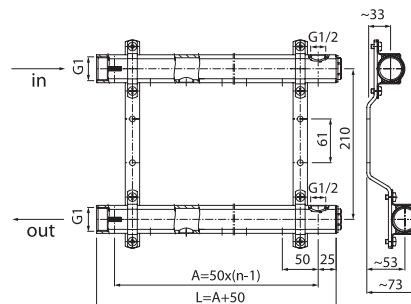
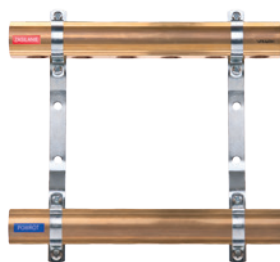

Kod	Wymiary				P nom. / T max	Ilość szt.	Opakow.	Waga netto	Kod	Cena
	Wymiar	n	A	L						
6086010	G1-G1/2	2	50	100	PN 10 / 95°C	1	P-6086.03	1.006	6086010	115,70 zł
6086020	G1-G1/2	3	100	150	PN 10 / 95°C	1	P-6086.03	1.622	6086020	170,20 zł
6086030	G1-G1/2	4	150	200	PN 10 / 95°C	1	P-6086.03	1.989	6086030	203,20 zł
6086040	G1-G1/2	5	200	250	PN 10 / 95°C	1	P-6086.06	2.378	6086040	244,60 zł
6086050	G1-G1/2	6	250	300	PN 10 / 95°C	1	P-6086.06	2.743	6086050	280,90 zł
6086060	G1-G1/2	7	300	350	PN 10 / 95°C	1	P-6086.06	3.102	6086060	317,20 zł
6086070	G1-G1/2	8	350	400	PN 10 / 95°C	1	P-6086.09	3.467	6086070	358,50 zł
6086080	G1-G1/2	9	400	450	PN 10 / 95°C	1	P-6086.09	3.854	6086080	410,00 zł
6086090	G1-G1/2	10	450	500	PN 10 / 95°C	1	P-6086.09	4.226	6086090	454,50 zł
6086100	G1-G1/2	11	500	550	PN 10 / 95°C	1	P-6086.11	4.571	6086100	480,90 zł
6086110	G1-G1/2	12	550	600	PN 10 / 95°C	1	P-6086.11	4.940	6086110	535,40 zł

48. PROFF
Zespół rozdzielaczy PROFF
K2

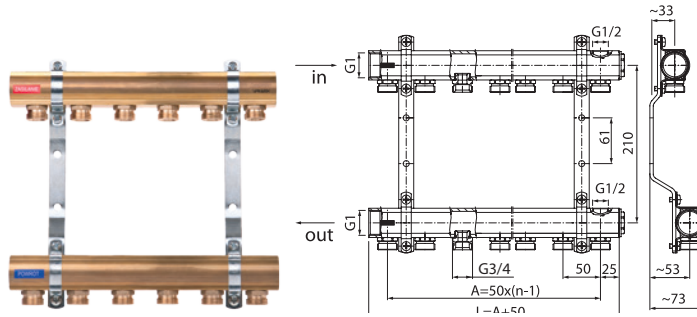

Kod	Wymiary			P nom. / T max	Ilość szt.	Opakow.	Waga netto	Kod	Cena	
	Wymiar	n	A							L
6086260	G1-G3/4	2	50	100	PN 10 / 95°C	1	P-6086.03	1.193	6086260	144,80 zł
6086270	G1-G3/4	3	100	150	PN 10 / 95°C	1	P-6086.03	1.912	6086270	212,30 zł
6086280	G1-G3/4	4	150	200	PN 10 / 95°C	1	P-6086.03	2.373	6086280	261,20 zł
6086290	G1-G3/4	5	200	250	PN 10 / 95°C	1	P-6086.06	2.837	6086290	308,90 zł
6086300	G1-G3/4	6	250	300	PN 10 / 95°C	1	P-6086.06	3.315	6086300	355,30 zł
6086310	G1-G3/4	7	300	350	PN 10 / 95°C	1	P-6086.06	3.750	6086310	408,10 zł
6086320	G1-G3/4	8	350	400	PN 10 / 95°C	1	P-6086.09	4.214	6086320	459,50 zł
6086330	G1-G3/4	9	400	450	PN 10 / 95°C	1	P-6086.09	4.687	6086330	533,90 zł
6086340	G1-G3/4	10	450	500	PN 10 / 95°C	1	P-6086.09	5.152	6086340	589,60 zł
6086350	G1-G3/4	11	500	550	PN 10 / 95°C	1	P-6086.11	5.591	6086350	631,80 zł
6086360	G1-G3/4	12	550	600	PN 10 / 95°C	1	P-6086.11	6.053	6086360	699,10 zł

49. PROFF
Zespół rozdzielaczy PROFF K2 MINI

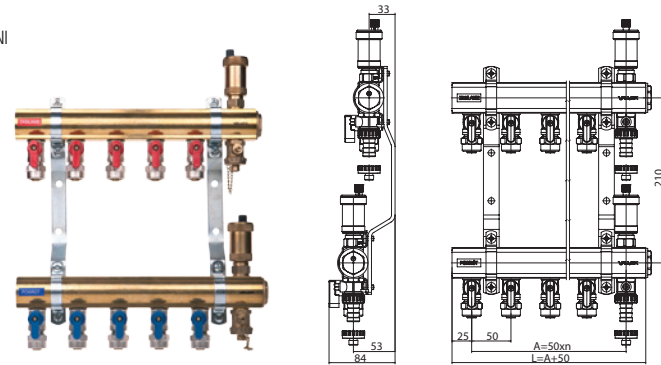

Kod	Wymiary			P nom. / T max	Ilość szt.	Opakow.	Waga netto	Kod	Cena	
	Wymiar	n	A							L
6084300	G1 - PEX 16x2	2	100	150	PN 10 / 95°C	1	P-6086.03	2.461	6084300	318,20 zł
6084310	G1 - PEX 16x2	3	150	200	PN 10 / 95°C	1	P-6086.03	3.279	6084310	395,10 zł
6084320	G1 - PEX 16x2	4	200	250	PN 10 / 95°C	1	P-6086.06	3.931	6084320	472,30 zł
6084330	G1 - PEX 16x2	5	250	300	PN 10 / 95°C	1	P-6086.06	4.596	6084330	555,50 zł
6084340	G1 - PEX 16x2	6	300	350	PN 10 / 95°C	1	P-6086.06	5.260	6084340	634,30 zł
6084350	G1 - PEX 16x2	7	350	400	PN 10 / 95°C	1	P-6086.09	5.924	6084350	709,40 zł
6084360	G1 - PEX 16x2	8	400	450	PN 10 / 95°C	1	P-6086.09	6.588	6084360	792,60 zł
6084370	G1 - PEX 16x2	9	450	500	PN 10 / 95°C	1	P-6086.09	7.253	6084370	878,90 zł
6084380	G1 - PEX 16x2	10	500	550	PN 10 / 95°C	1	P-6086.11	7.917	6084380	962,90 zł
6084390	G1 - PEX 16x2	11	550	600	PN 10 / 95°C	1	P-6086.11	8.581	6084390	1 033,10 zł

50. PROFF
Zespół rozdzielaczy PROFF
K3

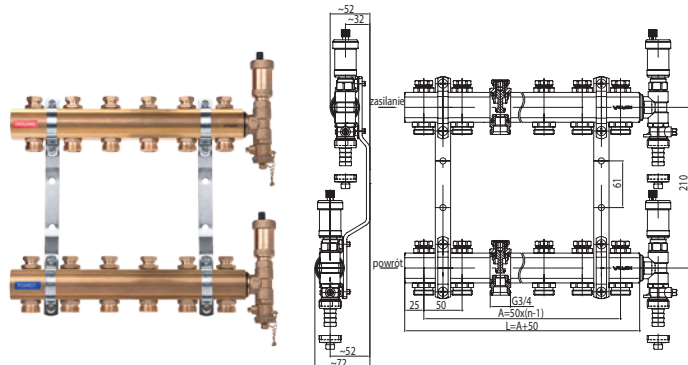

Kod	Wymiary			P nom. / T max	Ilość szt.	Opakow.	Waga netto	Kod	Cena	
	Wymiar	n	A							L
6086500	G1-G3/4	2	50	100	PN 10 / 95°C	1	P-6086.03	1.907	6086500	287,50 zł
6086510	G1-G3/4	3	100	150	PN 10 / 95°C	1	P-6086.03	3.021	6086510	347,40 zł
6086520	G1-G3/4	4	150	200	PN 10 / 95°C	1	P-6086.03	3.674	6086520	402,70 zł
6086530	G1-G3/4	5	200	250	PN 10 / 95°C	1	P-6086.06	4.320	6086530	462,90 zł
6086540	G1-G3/4	6	250	300	PN 10 / 95°C	1	P-6086.06	4.980	6086540	527,80 zł
6086550	G1-G3/4	7	300	350	PN 10 / 95°C	1	P-6086.06	5.638	6086550	587,80 zł
6086560	G1-G3/4	8	350	400	PN 10 / 95°C	1	P-6086.09	6.297	6086560	648,00 zł
6086570	G1-G3/4	9	400	450	PN 10 / 95°C	1	P-6086.09	6.955	6086570	720,20 zł
6086580	G1-G3/4	10	450	500	PN 10 / 95°C	1	P-6086.09	7.614	6086580	792,20 zł
6086590	G1-G3/4	11	500	550	PN 10 / 95°C	1	P-6086.11	8.273	6086590	852,30 zł
6086600	G1-G3/4	12	550	600	PN 10 / 95°C	1	P-6086.11	8.931	6086600	936,50 zł

51. PROFF
Zespół rozdzielaczy PROFF
K4

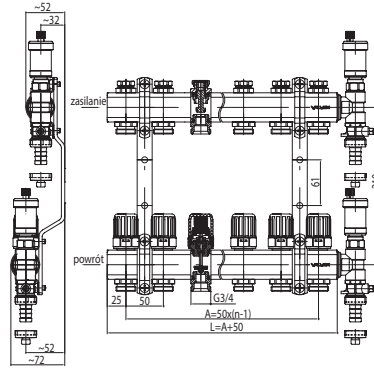
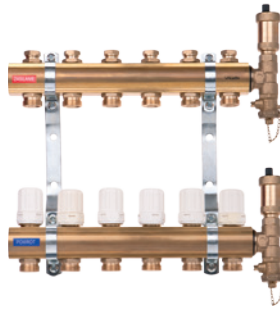

Kod	Wymiary			P nom. / T max	Ilość szt.	Opakow.	Waga netto	Kod	Cena	
	Wymiar	n	A							L
6086630	G1-G3/4	2	50	100	PN 10 / 95°C	1	P-6086.03	1.937	6086630	299,40 zł
6086640	G1-G3/4	3	100	150	PN 10 / 95°C	1	P-6086.03	3.066	6086640	355,90 zł
6086650	G1-G3/4	4	150	200	PN 10 / 95°C	1	P-6086.06	3.734	6086650	420,90 zł
6086660	G1-G3/4	5	200	250	PN 10 / 95°C	1	P-6086.06	4.395	6086660	491,60 zł
6086670	G1-G3/4	6	250	300	PN 10 / 95°C	1	P-6086.06	5.070	6086670	557,80 zł
6086680	G1-G3/4	7	300	350	PN 10 / 95°C	1	P-6086.09	5.743	6086680	620,30 zł
6086690	G1-G3/4	8	350	400	PN 10 / 95°C	1	P-6086.09	6.417	6086690	691,20 zł
6086700	G1-G3/4	9	400	450	PN 10 / 95°C	1	P-6086.09	7.090	6086700	764,70 zł
6086710	G1-G3/4	10	450	500	PN 10 / 95°C	1	P-6086.11	7.764	6086710	836,70 zł
6086720	G1-G3/4	11	500	550	PN 10 / 95°C	1	P-6086.11	8.438	6086720	894,10 zł
6086730	G1-G3/4	12	550	600	PN 10 / 95°C	1	P-6086.11	9.111	6086730	978,20 zł

52. PROFF
Zespół rozdzielaczy PROFF
K5

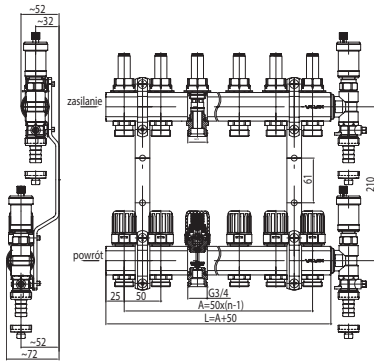

Kod	Wymiary			P nom. / T max	Ilość szt.	Opakow.	Waga netto	Kod	Cena	
	Wymiar	n	A							L
6086750	G1-G3/4	2	50	100	PN 6 / 70°C	1	P-6086.75	3.029	6086750	347,40 zł
6086760	G1-G3/4	3	100	150	PN 6 / 70°C	1	P-6086.75	3.685	6086760	395,60 zł
6086770	G1-G3/4	4	150	200	PN 6 / 70°C	1	P-6086.75	4.334	6086770	479,70 zł
6086780	G1-G3/4	5	200	250	PN 6 / 70°C	1	P-6086.78	4.996	6086780	548,10 zł
6086790	G1-G3/4	6	250	300	PN 6 / 70°C	1	P-6086.78	5.657	6086790	625,10 zł
6086800	G1-G3/4	7	300	350	PN 6 / 70°C	1	P-6086.78	6.318	6086800	720,20 zł
6086810	G1-G3/4	8	350	400	PN 6 / 70°C	1	P-6086.81	6.980	6086810	792,20 zł
6086820	G1-G3/4	9	400	450	PN 6 / 70°C	1	P-6086.81	7.641	6086820	877,60 zł
6086830	G1-G3/4	10	450	500	PN 6 / 70°C	1	P-6086.81	8.302	6086830	979,90 zł
6086840	G1-G3/4	11	500	550	PN 6 / 70°C	1	P-6086.84	8.964	6086840	1 050,00 zł
6086850	G1-G3/4	12	550	600	PN 6 / 70°C	1	P-6086.84	9.111	6086850	1 155,00 zł

53. BASE
Belka rozdzielacza BASE INOX

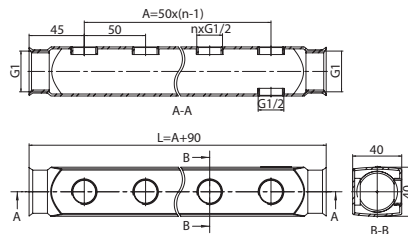

Kod	Wymiary			P nom. / T max	Ilość szt.	Opakow.	Waga netto	Kod	Cena	
	Wymiar	n	A							L
6085870	G1-G1/2	2	50	140	PN 10 / 95°C	24	P-6085.00	0.266	6085870	33,40 zł
6085880	G1-G1/2	3	100	190	PN 10 / 95°C	16	P-6085.00	0.358	6085880	46,60 zł
6085890	G1-G1/2	4	150	240	PN 10 / 95°C	14	P-6085.00	0.450	6085890	57,40 zł
6085900	G1-G1/2	5	200	290	PN 10 / 95°C	14	P-6085.03	0.542	6085900	66,80 zł
6085910	G1-G1/2	6	250	340	PN 10 / 95°C	14	P-6085.03	0.634	6085910	76,50 zł
6085920	G1-G1/2	7	300	390	PN 10 / 95°C	14	P-6085.03	0.726	6085920	86,00 zł
6085930	G1-G1/2	8	350	440	PN 10 / 95°C	14	P-6085.07	0.818	6085930	95,50 zł
6085940	G1-G1/2	9	400	490	PN 10 / 95°C	14	P-6085.07	0.910	6085940	105,10 zł
6085950	G1-G1/2	10	450	540	PN 10 / 95°C	14	P-6085.07	1.002	6085950	114,80 zł
6085960	G1-G1/2	11	500	590	PN 10 / 95°C	14	P-6085.10	1.094	6085960	124,20 zł
6085970	G1-G1/2	12	550	640	PN 10 / 95°C	14	P-6085.10	1.184	6085970	133,90 zł

54. **BASE**
Zespół rozdzielaczy BASE INOX K1

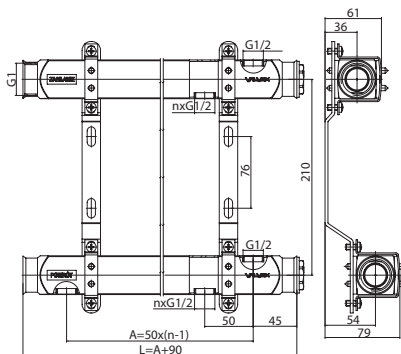

Kod	Wymiary				P nom. / T max	Ilość szt.	Opakow.	Waga netto	Kod	Cena
	Wymiar	n	A	L						
6085000	G1-G1/2	2	50	140	PN 10 / 95°C	1	P-6085.00	0.793	6085000	108,90 zł
6085010	G1-G1/2	3	100	190	PN 10 / 95°C	1	P-6085.00	1.137	6085010	125,50 zł
6085020	G1-G1/2	4	150	240	PN 10 / 95°C	1	P-6085.00	1.321	6085020	140,70 zł
6085030	G1-G1/2	5	200	290	PN 10 / 95°C	1	P-6085.03	1.505	6085030	159,80 zł
6085040	G1-G1/2	6	250	340	PN 10 / 95°C	1	P-6085.03	1.689	6085040	176,20 zł
6085050	G1-G1/2	7	300	390	PN 10 / 95°C	1	P-6085.03	1.873	6085050	202,30 zł
6085060	G1-G1/2	8	350	440	PN 10 / 95°C	1	P-6085.07	2.057	6085060	222,40 zł
6085070	G1-G1/2	9	400	490	PN 10 / 95°C	1	P-6085.07	2.241	6085070	247,30 zł
6085080	G1-G1/2	10	450	540	PN 10 / 95°C	1	P-6085.07	2.425	6085080	273,20 zł
6085090	G1-G1/2	11	500	590	PN 10 / 95°C	1	P-6085.10	2.609	6085090	300,50 zł
6085100	G1-G1/2	12	550	640	PN 10 / 95°C	1	P-6085.10	2.789	6085100	341,80 zł

55. **BASE**
Zespół rozdzielaczy BASE INOX K2

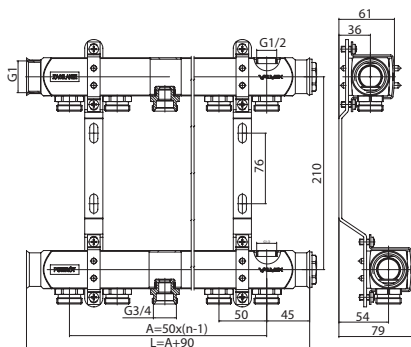

Kod	Wymiary				P nom. / T max	Ilość szt.	Opakow.	Waga netto	Kod	Cena
	Wymiar	n	A	L						
6085150	G1-G3/4	2	50	140	PN 10 / 95°C	1	P-6085.00	1.185	6085150	130,50 zł
6085160	G1-G3/4	3	100	190	PN 10 / 95°C	1	P-6085.00	1.485	6085160	154,60 zł
6085170	G1-G3/4	4	150	240	PN 10 / 95°C	1	P-6085.00	1.785	6085170	182,00 zł
6085180	G1-G3/4	5	200	290	PN 10 / 95°C	1	P-6085.03	2.085	6085180	214,30 zł
6085190	G1-G3/4	6	250	340	PN 10 / 95°C	1	P-6085.03	2.385	6085190	244,20 zł
6085200	G1-G3/4	7	300	390	PN 10 / 95°C	1	P-6085.03	2.685	6085200	274,30 zł
6085210	G1-G3/4	8	350	440	PN 10 / 95°C	1	P-6085.07	2.985	6085210	310,10 zł
6085220	G1-G3/4	9	400	490	PN 10 / 95°C	1	P-6085.07	3.285	6085220	354,50 zł
6085230	G1-G3/4	10	450	540	PN 10 / 95°C	1	P-6085.07	3.585	6085230	390,40 zł
6085240	G1-G3/4	11	500	590	PN 10 / 95°C	1	P-6085.10	3.885	6085240	429,90 zł
6085250	G1-G3/4	12	550	640	PN 10 / 95°C	1	P-6085.10	4.181	6085250	465,90 zł

56. **BASE**
Zespół rozdzielaczy BASE INOX K2MINI

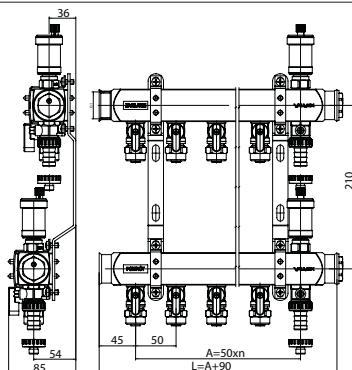
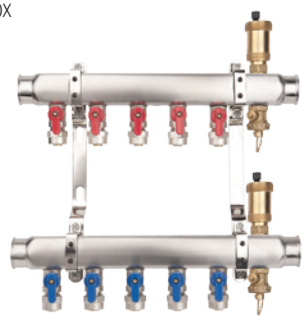

Kod	Wymiary				P nom. / T max	Ilość szt.	Opakow.	Waga netto	Kod	Cena
	Wymiar	n	A	L						
6084000	G1-PEX 16x2	2	100	190	PN 10 / 95°C	1	P-6085.00	2.033	6084000	264,70 zł
6084010	G1-PEX 16x2	3	150	240	PN 10 / 95°C	1	P-6085.00	2.650	6084010	325,20 zł
6084020	G1-PEX 16x2	4	200	290	PN 10 / 95°C	1	P-6085.03	3.109	6084020	385,60 zł
6084030	G1-PEX 16x2	5	250	340	PN 10 / 95°C	1	P-6085.03	3.567	6084030	453,40 zł
6084040	G1-PEX 16x2	6	300	390	PN 10 / 95°C	1	P-6085.03	4.025	6084040	513,70 zł
6084050	G1-PEX 16x2	7	350	440	PN 10 / 95°C	1	P-6085.07	4.484	6084050	579,00 zł
6084060	G1-PEX 16x2	8	400	490	PN 10 / 95°C	1	P-6085.07	4.942	6084060	639,50 zł
6084070	G1-PEX 16x2	9	450	540	PN 10 / 95°C	1	P-6085.07	5.401	6084070	704,70 zł
6084080	G1-PEX 16x2	10	500	590	PN 10 / 95°C	1	P-6085.10	5.859	6084080	767,70 zł
6084090	G1-PEX 16x2	11	550	640	PN 10 / 95°C	1	P-6085.10	6.313	6084090	828,10 zł

57. BASE
Zespół rozdzielaczy BASE INOX K3

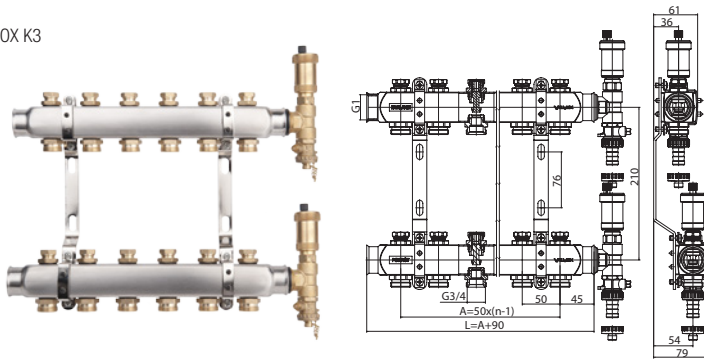

Kod	Wymiary			P nom. / T max	Ilość szt.	Opakow.	Waga netto	Kod	Cena	
	Wymiar	n	A							L
6085300	G1-G3/4	2	50	140	PN 10 / 95°C	1	P-6085.00	2.003	6085300	258,80 zł
6085310	G1-G3/4	3	100	190	PN 10 / 95°C	1	P-6085.00	2.635	6085310	307,10 zł
6085320	G1-G3/4	4	150	240	PN 10 / 95°C	1	P-6085.00	2.947	6085320	349,30 zł
6085330	G1-G3/4	5	200	290	PN 10 / 95°C	1	P-6085.03	3.579	6085330	397,70 zł
6085340	G1-G3/4	6	250	340	PN 10 / 95°C	1	P-6085.03	4.051	6085340	446,10 zł
6085350	G1-G3/4	7	300	390	PN 10 / 95°C	1	P-6085.03	4.523	6085350	506,40 zł
6085360	G1-G3/4	8	350	440	PN 10 / 95°C	1	P-6085.07	4.995	6085360	554,70 zł
6085370	G1-G3/4	9	400	490	PN 10 / 95°C	1	P-6085.07	5.467	6085370	615,30 zł
6085380	G1-G3/4	10	450	540	PN 10 / 95°C	1	P-6085.07	5.939	6085380	670,90 zł
6085390	G1-G3/4	11	500	590	PN 10 / 95°C	1	P-6085.10	6.411	6085390	724,10 zł
6085400	G1-G3/4	12	550	640	PN 10 / 95°C	1	P-6085.10	6.881	6085400	790,60 zł

58. BASE
Zespół rozdzielaczy BASE INOX K4

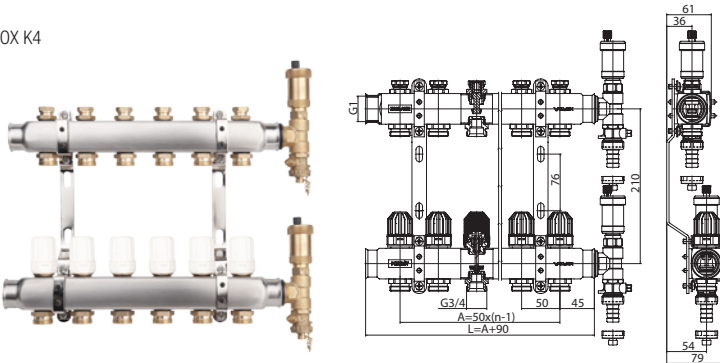

Kod	Wymiary			P nom. / T max	Ilość szt.	Opakow.	Waga netto	Kod	Cena	
	Wymiar	n	A							L
6085450	G1-G3/4	2	50	140	PN 10 / 95°C	1	P-6085.00	2.033	6085450	288,90 zł
6085460	G1-G3/4	3	100	190	PN 10 / 95°C	1	P-6085.00	2.680	6085460	337,30 zł
6085470	G1-G3/4	4	150	240	PN 10 / 95°C	1	P-6085.00	3.167	6085470	388,00 zł
6085480	G1-G3/4	5	200	290	PN 10 / 95°C	1	P-6085.03	3.654	6085480	433,90 zł
6085490	G1-G3/4	6	250	340	PN 10 / 95°C	1	P-6085.03	4.141	6085490	482,40 zł
6085500	G1-G3/4	7	300	390	PN 10 / 95°C	1	P-6085.03	4.628	6085500	539,10 zł
6085510	G1-G3/4	8	350	440	PN 10 / 95°C	1	P-6085.07	5.115	6085510	591,10 zł
6085520	G1-G3/4	9	400	490	PN 10 / 95°C	1	P-6085.07	5.602	6085520	646,70 zł
6085530	G1-G3/4	10	450	540	PN 10 / 95°C	1	P-6085.07	6.089	6085530	720,50 zł
6085540	G1-G3/4	11	500	590	PN 10 / 95°C	1	P-6085.10	6.576	6085540	784,50 zł
6085550	G1-G3/4	12	550	640	PN 10 / 95°C	1	P-6085.10	7.061	6085550	844,90 zł

59. BASE
Zespół rozdzielaczy BASE INOX K5

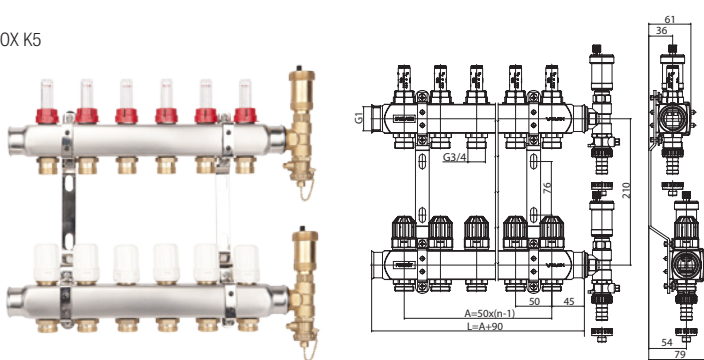

Kod	Wymiary			P nom. / T max	Ilość szt.	Opakow.	Waga netto	Kod	Cena	
	Wymiar	n	A							L
6085600	G1-G3/4	2	50	140	PN 6 / 70°C	1	P-6085.60	2.009	6085600	313,00 zł
6085610	G1-G3/4	3	100	190	PN 6 / 70°C	1	P-6085.60	2.643	6085610	373,60 zł
6085620	G1-G3/4	4	150	240	PN 6 / 70°C	1	P-6085.60	3.117	6085620	421,90 zł
6085630	G1-G3/4	5	200	290	PN 6 / 70°C	1	P-6085.63	3.592	6085630	482,40 zł
6085640	G1-G3/4	6	250	340	PN 6 / 70°C	1	P-6085.63	4.067	6085640	554,70 zł
6085650	G1-G3/4	7	300	390	PN 6 / 70°C	1	P-6085.63	4.542	6085650	615,30 zł
6085660	G1-G3/4	8	350	440	PN 6 / 70°C	1	P-6085.66	5.016	6085660	687,80 zł
6085670	G1-G3/4	9	400	490	PN 6 / 70°C	1	P-6085.66	5.491	6085670	748,20 zł
6085680	G1-G3/4	10	450	540	PN 6 / 70°C	1	P-6085.66	5.966	6085680	832,80 zł
6085690	G1-G3/4	11	500	590	PN 6 / 70°C	1	P-6085.69	6.440	6085690	917,40 zł
6085700	G1-G3/4	12	550	640	PN 6 / 70°C	1	P-6085.69	6.913	6085700	1 024,00 zł

60. BASE + PROFF

Zestaw rozdzielaczy BASE K5 z grupą pompowo-mieszającą PROFF

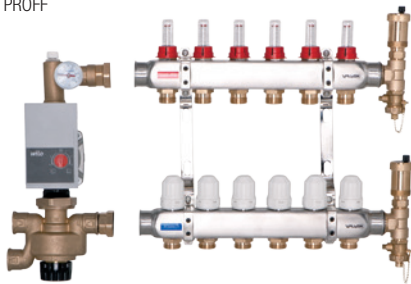

Rys. techn.:

- poz. 58
- poz. 60

Kod	Wymiary			P nom. / T max	Ilość szt.	Opakow.	Waga netto	Kod	Cena
	Wymiar	n	A L						
6088650	G1-G3/4	2	50 140	PN 6 / 70°C	1	P-6085.60	5,893	6088650	1 835,00 zł
6088660	G1-G3/4	3	100 190	PN 6 / 70°C	1	P-6085.60	6,527	6088660	1 889,00 zł
6088670	G1-G3/4	4	150 240	PN 6 / 70°C	1	P-6085.60	7,001	6088670	1 943,00 zł
6088680	G1-G3/4	5	200 290	PN 6 / 70°C	1	P-6085.63	7,476	6088680	1 997,00 zł
6088690	G1-G3/4	6	250 340	PN 6 / 70°C	1	P-6085.63	7,951	6088690	2 051,00 zł
6088700	G1-G3/4	7	300 390	PN 6 / 70°C	1	P-6085.63	8,426	6088700	2 105,00 zł
6088710	G1-G3/4	8	350 440	PN 6 / 70°C	1	P-6085.66	8,900	6088710	2 159,00 zł
6088720	G1-G3/4	9	400 490	PN 6 / 70°C	1	P-6085.66	9,375	6088720	2 213,00 zł
6088730	G1-G3/4	10	450 540	PN 6 / 70°C	1	P-6085.66	9,850	6088730	2 267,00 zł
6088740	G1-G3/4	11	500 590	PN 6 / 70°C	1	P-6085.69	10,324	6088740	2 375,00 zł
6088750	G1-G3/4	12	550 640	PN 6 / 70°C	1	P-6085.69	10,797	6088750	2 483,00 zł

61. PROFF

Grupa pompowo-mieszająca PROFF

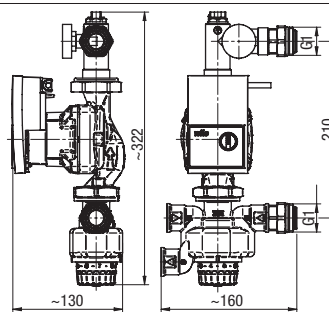

Kod	P nom.	Temp. nom.	mH ₂ O	Ilość szt.	Opakow.	Waga netto	Kod	Cena
6096700	PN 6	70°C	6	1	P-2449.98	3.884	6096700	1 764,00 zł

62. BASE

Grupa mieszająca bez pompy

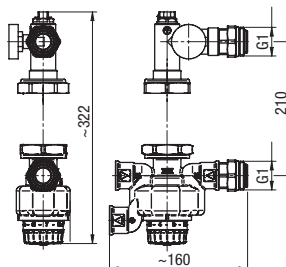

Kod	P nom.	Temp. nom.	Ilość szt.	Opakow.	Waga netto	Kod	Cena
6096720	PN 10	70°C	1	P-2449.98	2,116	6096720	810,00 zł

63. PROFFmix

Grupa pompowa z zaworem 3-drogowym i siłownikiem

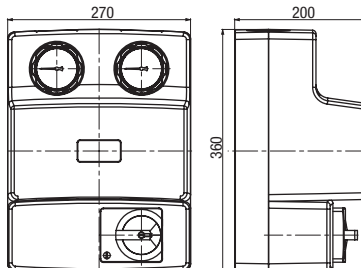

Kod	P nom.	Temp. nom.	mH ₂ O	Ilość szt.	Opakow.	Waga netto	Kod	Cena
6096800	PN 6	95°C	6	1	P-2449.98	6,642	6096800	2 159,00 zł

64. PROFFco
Grupa pompowa

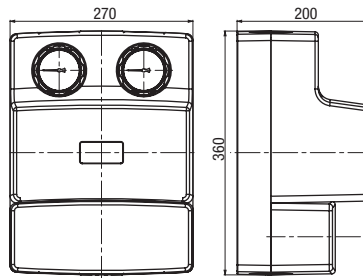

Kod	P nom.	Temp. nom.	mH ₂ O	Ilość szt.	Opakow.	Waga netto
6096820	PN 6	95°C	6	1	P-2449.98	5,954

Kod	Cena
6096820	1 565,00 zł

65. PROFFmix
Grupa pompowa PROFFmix
bez pompy

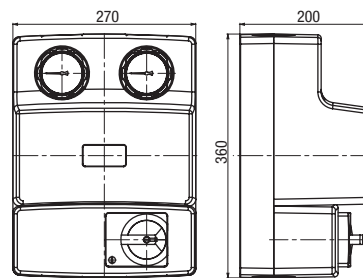

Kod	P nom.	Temp. nom.	Ilość szt.	Opakow.	Waga netto
6096870	PN 6	95°C	1	P-2449.98	4,794

Kod	Cena
6096870	1 458,00 zł

66. PROFFco
Grupa pompowa PROFFco
bez pompy

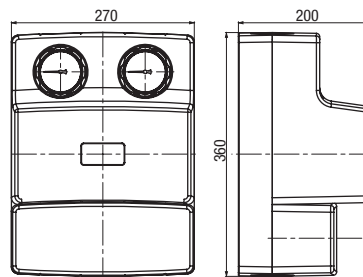

Kod	P nom.	Temp. nom.	Ilość szt.	Opakow.	Waga netto
6096880	PN 6	95°C	1	P-2449.98	3,962

Kod	Cena
6096880	788,40 zł

67. COMBI
Rozdzielacz kotłowy COMBI

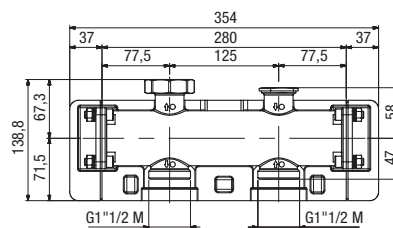

Kod	Ilość szt.	Opakow.	Waga netto
6096760	1	P-6096.76	3,069

Kod	Cena
6096760	571,30 zł

68. COMBI
Zasłepka do rozdzielacza kotłowego



Kod	Ilość szt.	Opakow.	Waga netto
6096770	20/1	P-1472.60/1 / woreczek foliowy	0,183

Kod	Cena
6096770	48,60 zł

69. **CONTROLMIX3**
Zawór mieszający 3-drogowy

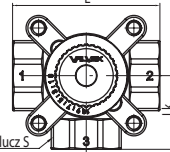
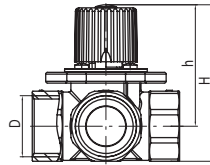

Wymiar pod klucz 5

DN	Kod	Wymiary						
		S	Lk	D	L	H	h	
20	6093100	31	38,5	R3/4	77	86	68	
25	6094100	39	41	R1	82	87	68	
32	6095100	49	46	R1 1/4	92	94	70	

DN	Kod	P nom.	Temp. nom.	Kvs	Moment obrotu wrzeczona	Rodzaje płynów	Ilość szt.	Opakow.	Waga netto	Kod	Cena
20	6093100	PN 10	-10°C ÷ 110°C	6,3 (m³/h)	<1 Nm	woda, glikol (≤50%)	1	P-6094.12	0,611	6093100	138,00 zł
25	6094100	PN 10	-10°C ÷ 110°C	12 (m³/h)	<1 Nm	woda, glikol (≤50%)	1	P-6094.12	0,752	6094100	150,00 zł
32	6095100	PN 10	-10°C ÷ 110°C	16 (m³/h)	<1 Nm	woda, glikol (≤50%)	1	P-6095.12	1,105	6095100	169,00 zł

70. **CONTROLMIX4**
Zawór mieszający 4-drogowy

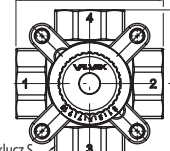
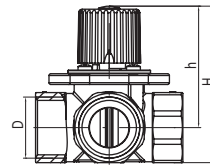

Wymiar pod klucz 5

DN	Kod	Wymiary						
		S	Lk	D	L	H	h	
20	6093120	31	-	R3/4	77	86	68	
25	6094120	39	-	R1	82	87	68	
32	6095120	49	-	R1 1/4	92	94	70	

DN	Kod	P nom.	Temp. nom.	Kvs	Moment obrotu wrzeczona	Rodzaje płynów	Ilość szt.	Opakow.	Waga netto	Kod	Cena
20	6093120	PN 10	-10°C ÷ 110°C	6,3 (m³/h)	<1 Nm	woda, glikol (≤50%)	1	P-6094.12	0,648	6093120	146,00 zł
25	6094120	PN 10	-10°C ÷ 110°C	12 (m³/h)	<1 Nm	woda, glikol (≤50%)	1	P-6094.12	0,870	6094120	158,00 zł
32	6095120	PN 10	-10°C ÷ 110°C	16 (m³/h)	<1 Nm	woda, glikol (≤50%)	1	P-6095.12	1,201	6095120	199,00 zł

71. **V-MIX ST 10/230**
Siłownik do zaworów



Kod	Kąt obrotu	Napięcie zasilania	Moment obrotowy	Czas otwarcia	Max temp. otoczenia	Ilość szt.	Opakow.	Waga netto	Kod	Cena
6098300	90°	230V / 50Hz	10 Nm	2 min.	50°C	1	P-6098.30	0,450	6098300	409,00 zł

72. **V-MIX STM 10/230**
Siłownik stałotemperaturowy z czujnikiem przylgowym



Kod	Zakres temp.	Kąt obrotu	Napięcie zasilania	Moment obrotowy	Czas otwarcia	Max temp. otoczenia	Ilość szt.	Opakow.	Waga netto	Kod	Cena
6098320	20°C ÷ 80°C	90°	230V / 50Hz	10 Nm	2 min.	50°C	1	P-6098.30	0,501	6098320	949,00 zł

73. **V-MIX ST 10/230**
Zestaw: siłownik + zawór mieszający 3-drogowy



DN	Kod	P nom.	Temp. nom.	Kvs	Moment obrotowy	Rodzaje płynów	Ilość szt.	Waga netto	Opakow.	Kod	Cena
20	6093140	PN 10	-10°C ÷ 110°C	6,3 (m³/h)	10 Nm	woda, glikol (≤50%)	1	1,112	P-6094.16	6093140	515,00 zł
25	6094140	PN 10	-10°C ÷ 110°C	12 (m³/h)	10 Nm	woda, glikol (≤50%)	1	1,217	P-6094.16	6094140	531,00 zł
32	6095140	PN 10	-10°C ÷ 110°C	16 (m³/h)	10 Nm	woda, glikol (≤50%)	1	1,570	P-6095.16	6095140	549,00 zł

74. V-MIX ST 10/230

Zestaw: siłownik + zawór mieszający
4-drogowy

DN	Kod	P nom.	Temp. nom.	Kvs	Moment obrotowy	Rodzaje płynów	Ilość szt.	Waga netto	Opakow.	Kod	Cena
20	6093160	PN 10	-10°C ÷ 110°C	6,3 (m³/h)	10 Nm	woda, glikol (≤50%)	1	1,157	P-6094.16	6093160	526,00 zł
25	6094160	PN 10	-10°C ÷ 110°C	12 (m³/h)	10 Nm	woda, glikol (≤50%)	1	1,256	P-6094.16	6094160	539,00 zł
32	6095160	PN 10	-10°C ÷ 110°C	16 (m³/h)	10 Nm	woda, glikol (≤50%)	1	1,666	P-6095.16	6095160	559,00 zł

75. V-MIX STM 10/230

Zestaw: siłownik + zawór mieszający
3-drogowy

DN	Kod	P nom.	Temp. nom.	Kvs	Moment obrotowy siłownika	Rodzaje płynów	Ilość szt.	Waga netto	Opakow.	Kod	Cena
20	6093180	PN 10	-10°C ÷ 110°C	6,3 (m³/h)	10 Nm	woda, glikol (≤50%)	1	1,127	P-6094.16	6093180	1 059,00 zł
25	6094180	PN 10	-10°C ÷ 110°C	12 (m³/h)	10 Nm	woda, glikol (≤50%)	1	1,267	P-6094.16	6094180	1 069,00 zł
32	6095180	PN 10	-10°C ÷ 110°C	16 (m³/h)	10 Nm	woda, glikol (≤50%)	1	1,620	P-6095.16	6095180	1 089,00 zł

76. V-MIX STM 10/230

Zestaw: siłownik + zawór mieszający
4-drogowy

DN	Kod	P nom.	Temp. nom.	Kvs	Moment obrotowy siłownika	Rodzaje płynów	Ilość szt.	Waga netto	Opakow.	Kod	Cena
20	6093200	PN 10	-10°C ÷ 110°C	6,3 (m³/h)	10 Nm	woda, glikol (≤50%)	1	1,162	P-6094.16	6093200	1 069,00 zł
25	6094200	PN 10	-10°C ÷ 110°C	12 (m³/h)	10 Nm	woda, glikol (≤50%)	1	1,338	P-6094.16	6094200	1 079,00 zł
32	6095190	PN 10	-10°C ÷ 110°C	16 (m³/h)	10 Nm	woda, glikol (≤50%)	1	1,716	P-6095.16	6095190	1 099,00 zł

77. V-THERM

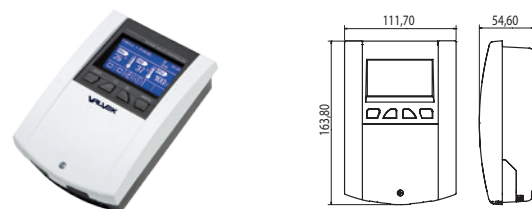
Sterownik do zaworów mieszających
z czujnikiem pogodowym

Kod	Zakres T (°C)	Napięcie zasilania	Pobór mocy	Ilość szt.	Opakow.	Waga netto	Kod	Cena
6098280	8-90	230V/50Hz +/- 10%	max. 4W	1	P-6098.20	0,443	6098280	473,00 zł

78. V-MIX ST 10/230

Zestaw: V-Therm + siłownik + zawór
mieszający 3-drogowy

DN	Kod	P nom.	Temp. nom.	Kvs	Rodzaje płynów	Ilość szt.	Waga netto	Opakow.	Kod	Cena
20	6093220	PN 10	-10°C ÷ 110°C	6,3 (m³/h)	woda, glikol (≤50%)	1	1,520	P-6098.30	6093220	999,00 zł
25	6094220	PN 10	-10°C ÷ 110°C	12 (m³/h)	woda, glikol (≤50%)	1	1,660	P-6098.30	6094220	1 009,00 zł
32	6095280	PN 10	-10°C ÷ 110°C	16 (m³/h)	woda, glikol (≤50%)	1	2,012	P-110	6095280	1 030,00 zł

79. V-MIX ST 10/230

Zestaw: V-Therm + siłownik + zawór
mieszający 4-drogowy

DN	Kod	P nom.	Temp. nom.	Kvs	Rodzaje płynów	Ilość szt.	Waga netto	Opakow.	Kod	Cena
20	6093240	PN 10	-10°C ÷ 110°C	6,3 (m³/h)	woda, glikol (≤50%)	1	1,555	P-6098.30	6093240	1 009,00 zł
25	6094240	PN 10	-10°C ÷ 110°C	12 (m³/h)	woda, glikol (≤50%)	1	1,731	P-6098.30	6094240	1 019,00 zł
32	6095290	PN 10	-10°C ÷ 110°C	16 (m³/h)	woda, glikol (≤50%)	1	2,108	P-110	6095290	1 055,00 zł

80. **PROFF**
Dobowy regulator temperatury, bezprzewodowy

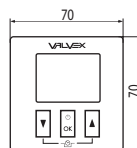

Kod	Sensor T (°C)	Zakres T (°C)	Wyświetlacz	Zasilanie	Częstotliwość / Zasięg	Ilość szt.	Opakow.	Waga netto
6098140	0-35	7-30	LCD	2xAAA 1.5V	868 MHz / 30 m	1	P-6098.14	0.050

Kod	Cena
6098140	132,00 zł

81. **PROFF**
Tygodniowy regulator temperatury, przewodowy

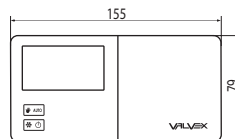

Kod	Sensor T (°C)	Zakres T (°C)	Wyświetlacz	Zasilanie	Częstotliwość / Zasięg	Ilość szt.	Opakow.	Waga netto
6098180	0-35	4-30	LCD	2xAA 1.5V	- / -	1	P-6098.18	0.200

Kod	Cena
6098180	199,00 zł

82. **PROFF**
Tygodniowy regulator temperatury, bezprzewodowy

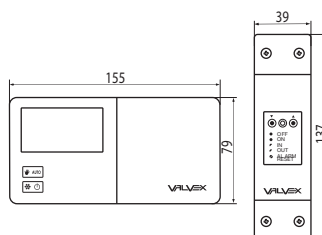

Kod	Sensor T (°C)	Zakres T (°C)	Wyświetlacz	Zasilanie	Częstotliwość / Zasięg	Ilość szt.	Opakow.	Waga netto
6098200	0-35	4-30	LCD	2xAA 1.5V	868 MHz / 30 m	1	P-6098.20	0.300

Kod	Cena
6098200	419,00 zł

83. **PROFF**
8 kanałowa centrala sterowania ogrzewaniem podłogowym LCD, bezprzewodowa

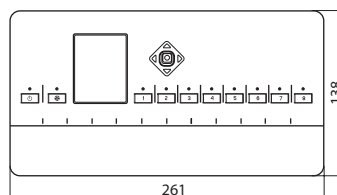

Kod	Zakres T (°C)	Zasilanie / Pojemność	Częstotliwość	Ilość szt.	Opakow.	Waga netto
6098220	4-45	230AC 50Hz / 3A	868 MHz	1	P-6098.22	0.600

Kod	Cena
6098220	1 449,00 zł

84. **BASE**
Tygodniowy regulator temperatury przewodowy

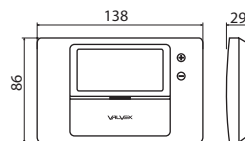

Kod	Sensor T (°C)	Zakres T (°C)	Wyświetlacz	Zasilanie	Częstotliwość / Zasięg	Ilość szt.	Opakow.	Waga netto
6098020	0-50	5-45	LCD	2xAA 1.5V	- / -	1	P-6098.02	0.112

Kod	Cena
6098020	236,00 zł

85. **BASE**
Tygodniowy regulator temperatury bezprzewodowy

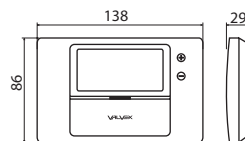

Kod	Sensor T (°C)	Zakres T (°C)	Wyświetlacz	Zasilanie	Częstotliwość / Zasięg	Ilość szt.	Opakow.	Waga netto
6098060	0-50	5-45	LCD	2xAA 1.5V	868 MHz / 30 m	1	P-6098.06	0.166

Kod	Cena
6098060	285,00 zł

86. BASE

Listwa sterowania ogrzewaniem
podłogowym przewodowa

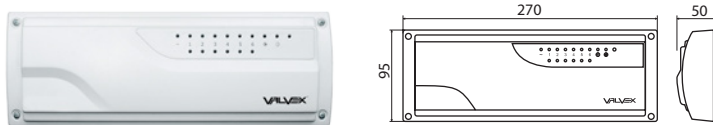

Kod	Zakres T (°C)	Zasilanie / Pojemność	Częstotliwość	Ilość szt.	Opakow.	Waga netto	Kod	Cena
6098080	5-40	230AC 50Hz / 3A	-	1	P-6098.08	0.493	6098080	299,00 zł

87. BASE

Listwa sterowania ogrzewaniem
podłogowym bezprzewodowa

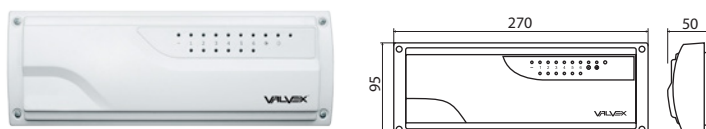

Kod	Zakres T (°C)	Zasilanie / Pojemność	Częstotliwość	Ilość szt.	Opakow.	Waga netto	Kod	Cena
6098100	5-40	230AC 50Hz / 3A	868 MHz	1	P-6098.10	0.648	6098100	439,00 zł

88. FEST

Zawór odcinający do rozdzielaczy
G 1/2

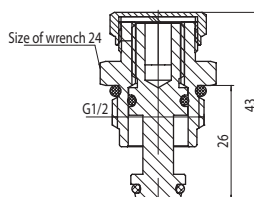

Kod	Wymiar	P nom. / max temp.	Ilość szt.	Opakow.	Waga netto	Kod	Cena
6097150	G1/2	PN 10, 100°C	50/10	P-38 / P-2406	0,086	6097150	10,50 zł

89. BYPASS

Bypass

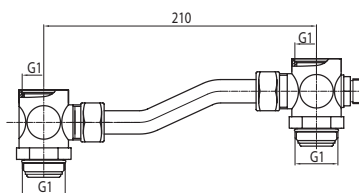

Kod	Wymiar	P nom. / max temp.	Ilość szt.	Opakow.	Waga netto	Kod	Cena
6096640	G1/2	PN 10 / 90°C	1	P-1477.60/1	0.900	6096640	178,00 zł

90. PROFF

Głowica termoelektryczna

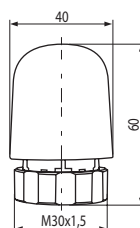

Kod	Typ	Zasilanie	Przyłącze	Ilość szt.	Opakow.	Waga netto	Kod	Cena
6098240	NC	230AC 50Hz	M30 x 1,5	1	P-6098.10	0.1000	6098240	80,10 zł

91. SECURE

Grupa bezpieczeństwa rozdzielacza

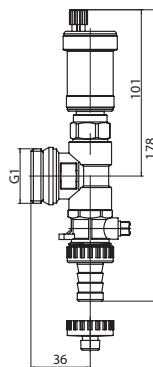

Kod	Wymiar	P nom. / max temp.	Ilość szt.	Opakow.	Waga netto	Kod	Cena
6097400	1x1/2x1/2	PN 10, 100°C	18/1	P-38 / P-2406	0,366	6097400	62,00 zł

92. DIRECT

Zawór termostatyczny do rozdzielacza do manualnego sterowania

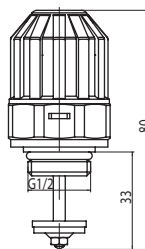

Kod	Wymiar	P nom. / max temp.	Ilość szt.	Opakow.	Waga netto	Kod	Cena
6097200	G1/2	PN 10, 100°C	25/1	P-38 / P-2406	0,101	6097200	13,80 zł

93. MINI

Zawór MINI z dławikiem czerwony, z oringiem i złączką pex/al 16x2

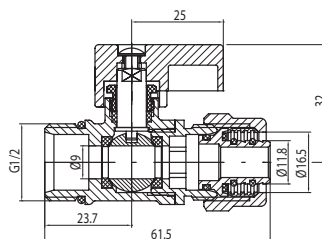

Kod	Wymiar	P nom. / max temp.	Ilość szt.	Opakow.	Waga netto	Kod	Cena
6097360	1/2"	PN 10, 65°C	30/1	P-43 / bag	0,137	6097360	19,95 zł

94. MINI

Zawór MINI z dławikiem niebieski, z oringiem i złączką pex/al 16x2

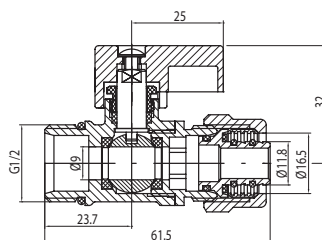

Kod	Wymiar	P nom. / max temp.	Ilość szt.	Opakow.	Waga netto	Kod	Cena
6097350	1/2"	PN 10, 65°C	30/1	P-43 / bag	0,137	6097350	19,95 zł

95. VISION

Przepływomierz do rozdzielaczy

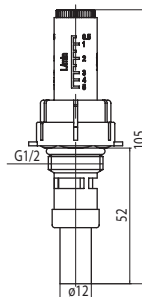

Kod	Wymiar	P nom. / max temp.	Ilość szt.	Opakow.	Waga netto	Kod	Cena
6097250	G1/2	PN 6 / 70°C	30/5	P-1	0,057	6097250	33,00 zł

96. **BASE**
Wspornik stalowy do rozdzielaczy

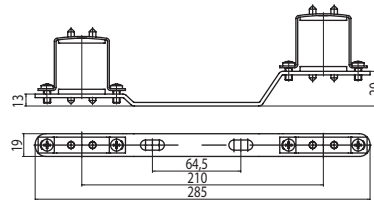

Kod	Ilość szt.	Opakow.	Waga netto
6097500	40/2	P-25 / woreczek foliowy	0,159

Kod	Cena
6097500	31,60 zł

97. **PROFF**
Wspornik stalowy do rozdzielaczy

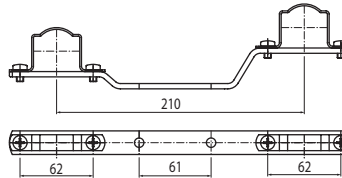

Kod	Ilość szt.	Opakow.	Waga netto
6090140	40/2	P-25 / woreczek foliowy	0,252

Kod	Cena
6090140	30,00 zł

98. **COPPER**
Przyłączka 15Cu-G3/4/18 niklowana

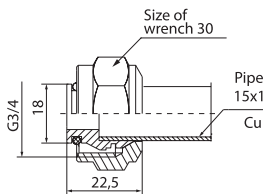

Kod	Wymiar	P nom. / max temp.	Ilość szt.	Opakow.	Waga netto
9003990	15Cu-G3/4	PN 10 / 90°C	135/15	P-1 / 22x25 woreczek foliowy	0,065

Kod	Cena
9003990	9,85 zł

99. **PEX**
Przyłączka G3/4 niklowana (do rur PEX)

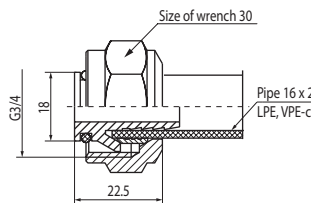

Kod	Wymiar	P nom. / max temp.	Ilość szt.	Opakow.	Waga netto
9006570	3/4"	PN 10 / 90°C	120/15	P-1 / woreczek foliowy	0,076

Kod	Cena
9006570	15,30 zł

100. **PEX-AL**
Przyłączka prosta 16x2-G3/4 niklowana

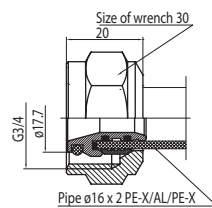

Kod	Wymiar	P nom. / max temp.	Ilość szt.	Opakow.	Waga netto
6008430	16x2-G3/4"	PN 10 / 90°C	90/15	P-1 / woreczek foliowy	0,065

Kod	Cena
6008430	13,40 zł

101. **VISION**
Złączka redukcyjna z oringiem G1/2-3/4 do przepływomierzy

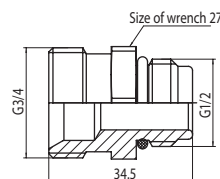

Kod	Wymiar	P nom.	Ilość szt.	Opakow.	Waga netto
6097100	1/2"-3/4"	PN 10	80/10	P-1 / P-14	0,075

Kod	Cena
6097100	7,10 zł

102. MICRA

Złączka wkrętna redukcyjna z oringiem 1/2"-3/4"-18 śrutowana

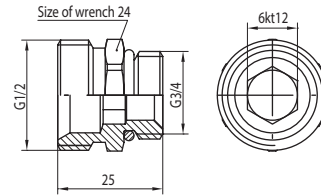

Kod	Wymiar	P nom.	Ilość szt.	Opakow.	Waga netto	Kod	Cena
6096220	1/2"-3/4"	PN 10	80/10	P-43 / 15x25 woreczek foliowy	0,046	6096220	6,70 zł

103. SUBER

Korek kolektora śrutowany

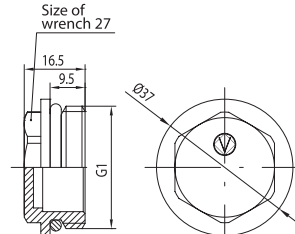

Kod	Wymiar	P nom. / max temp.	Ilość szt.	Opakow.	Waga netto	Kod	Cena
6096100	1"	PN 10 / 95°C	60/10	P-43 / 15x25 woreczek foliowy	0,051	6096100	7,45 zł

104. AXE

Złączka nakrętno-wkrętna redukcyjna G1-G3/4 do rury kolektora

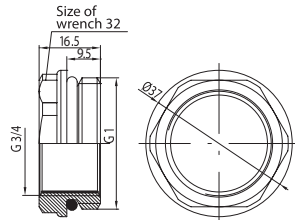

Kod	Wymiar	P nom. / max temp.	Ilość szt.	Opakow.	Waga netto	Kod	Cena
6096140	1"-3/4"	PN 10 / 95°C	60/10	P-43 / 15x25 woreczek foliowy	0,037	6096140	7,00 zł

105. VIRGO

Obejma ZT22 do głowicy GZ03 (zabezpieczenie głowicy przed demontażem)

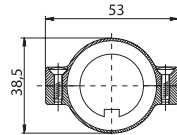

Kod	Wymiary		Ilość szt.	Opakow.	Waga netto	Kod	Cena
	A	L					
4413450	38,5	53	100	P-1	0,014	4413450	2,40 zł

106. VECTOR

Klucz do nastaw ZT22

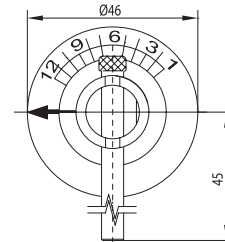

Kod	Ilość szt.	Opakow.	Waga netto	Kod	Cena
4412450	60	P-1	0,076	4412450	25,00 zł

107. VECTOR

Demoblok

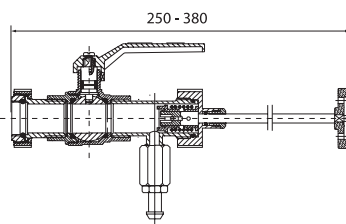

Kod	Ilość szt.	Waga netto	Kod	Cena
4411400	1	1,406	4411400	494,00 zł

108. VECTOR

Wkład ZT22 do zaworu termostatycznego

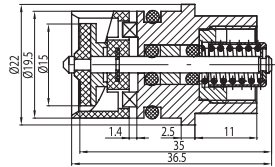

Kod	Ilość szt.	Opakow.	Waga netto	Kod	Cena
4412400	200	P-1	0,045	4412400	26,90 zł

109. PROTECTIVE CAP

Kolpak ochronny

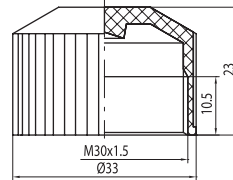

Kod	Ilość szt.	Opakow.	Waga netto	Kod	Cena
4412130	150	P-1	0,004	4412130	2,50 zł

110. ACTIV

Głowica do zaworów grzejnikowych PS i KS

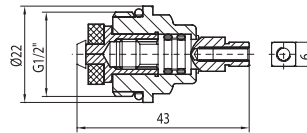

Kod	Wymiar	Ilość szt.	Opakow.	Waga netto	Kod	Cena
4482170	G1/2-14	200/20	P-1 / 22x25 woreczek foliowy	0,051	4482170	8,50 zł

111. VELA

Szafka podtynkowa

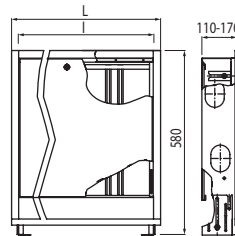

Kod	Wymiary			Ilość szt.	Ilość szt.	Waga netto	Kod	Cena
	Wersja	L	I					
6091600	SP-0	380	335	2-4	1	5,900	6091600	225,90 zł
6091610	SP-1	480	435	5-6	1	7,600	6091610	249,00 zł
6091620	Sp-2	610	565	7-8	1	8,700	6091620	271,10 zł
6091630	SP-3	760	715	9-10	1	10,000	6091630	305,60 zł
6091640	SP-4	840	795	11-12	1	11,100	6091640	335,40 zł
6091650	SP-5	1010	965	13-14	1	13,000	6091650	352,10 zł

112. VELA

Szafka natynkowa

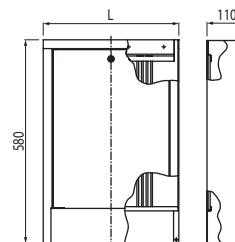

Kod	Wymiary			Ilość szt.	Ilość szt.	Waga netto	Kod	Cena
	Wersja	L	Ilość szt.					
6091700	SN-0	385	2-4	1	4,700	6091700	243,50 zł	
6091710	SN-1	485	5-6	1	5,200	6091710	279,10 zł	
6091720	SN-2	615	7-8	1	6,800	6091720	293,90 zł	
6091730	SN-3	760	9-10	1	8,000	6091730	316,20 zł	
6091740	SN-4	845	11-12	1	9,100	6091740	334,30 zł	
6091750	SN-5	1015	13-14	1	10,700	6091750	362,50 zł	

ARMATURA INSTALACYJNA CENTRALNEGO OGRZEWANIA

SYSTEMY INSTALACYJNE
- ZŁĄCZKI DO RUR STALOWYCH

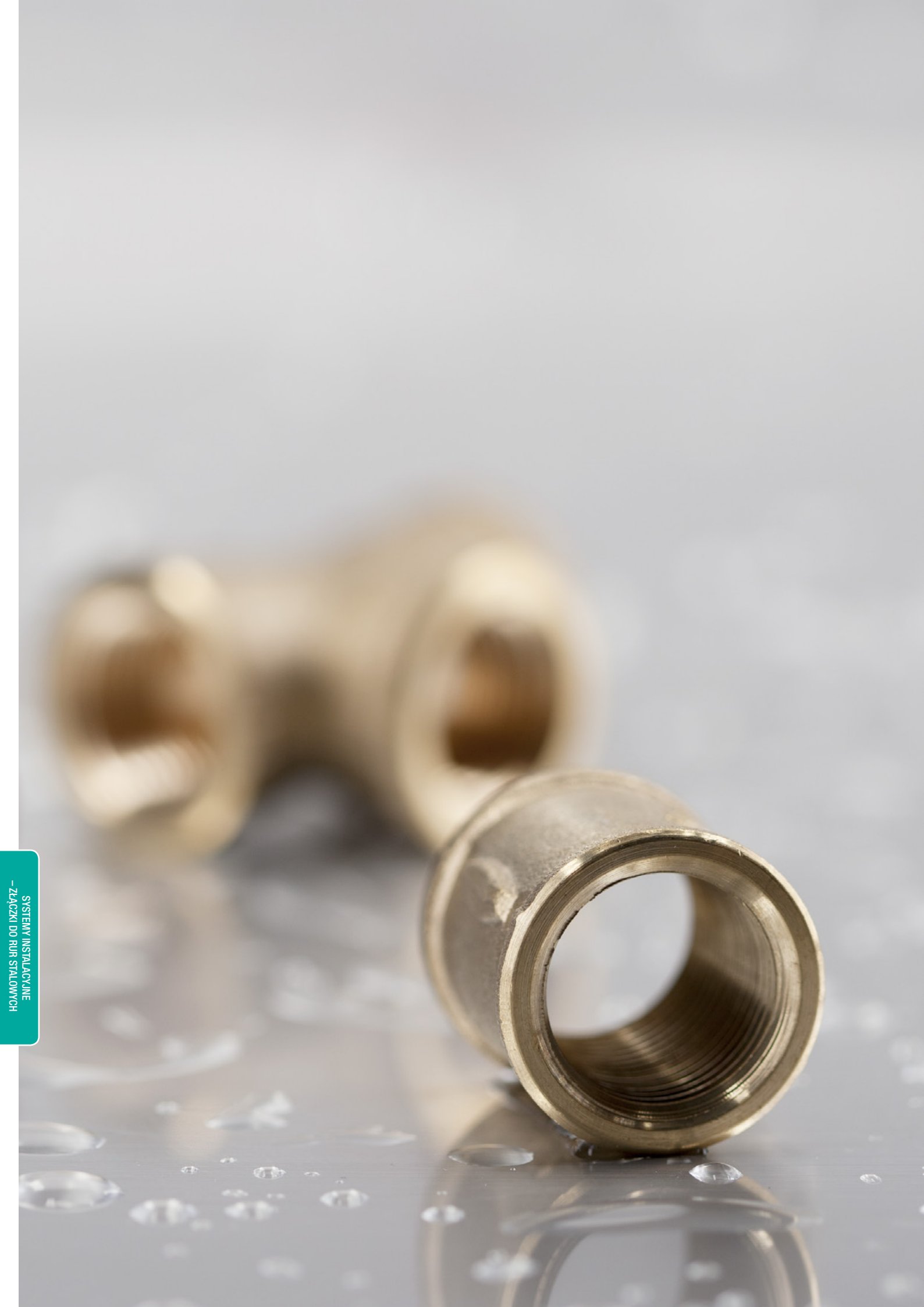

1. TWIST

Złączka prosta śrutowana (wersja długa), śrubunek

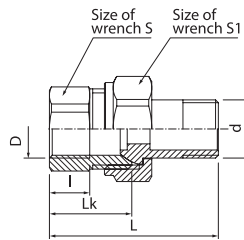

DN	Kod	Wymiary										P nom. / max temp.	Ilość szt.	Opakow.	Waga netto	Kod	Cena
		Rozmiar	D	d	L	Lk	I	S	S1								
10	4911010	3/8"	Rp3/8	R3/8	50	24	11	22	27	PN 10 / 100°C	50	P-43	0,102	4911010	11,30 zł		
15	4912010	1/2"	Rp1/2	R1/2	54	26	12	26	30	PN 10 / 100°C	50	P-43	0,124	4912010	15,50 zł		
20	4913010	3/4"	Rp3/4	R3/4	60	28	14	32	38	PN 10 / 100°C	50	P-1	0,189	4913010	23,50 zł		
25	4914010	1"	Rp1	R1	65	30	16	40	46	PN 10 / 100°C	50	P-1	0,303	4914010	34,90 zł		

2. TWIST

Złączka prosta niklowana (wersja długa), śrubunek

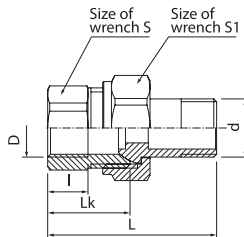

DN	Kod	Wymiary										P nom. / max temp.	Ilość szt.	Opakow.	Waga netto	Kod	Cena
		Rozmiar	D	d	L	Lk	I	S	S1								
15	4912020	1/2"	Rp1/2	R1/2	54	26	12	26	30	PN 10 / 100°C	50	P-43	0,124	4912020	15,50 zł		
20	4913020	3/4"	Rp3/4	R3/4	60	28	14	32	38	PN 10 / 100°C	50	P-1	0,189	4913020	21,00 zł		

3. TWIST

Złączka prosta śrutowana z oringiem (wersja długa), śrubunek

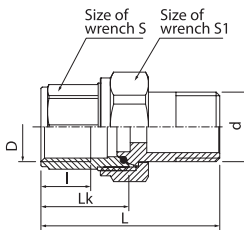

DN	Kod	Wymiary										P nom. / max temp.	Ilość szt.	Opakow.	Waga netto	Kod	Cena
		Rozmiar	D	d	L	Lk	I	S	S1								
15	4912030	1/2"	Rp1/2	R1/2	54	26	12	24	30	PN 10 / 100°C	50	P-43	0,103	4912030	15,50 zł		
20	4913030	3/4"	Rp3/4	R3/4	60	28	14	30	37	PN 10 / 100°C	50	P-1	0,162	4913030	23,10 zł		
25	4914030	1"	Rp1	R1	65	30	16	38	46	PN 10 / 100°C	30	P-1	0,267	4914030	32,20 zł		

4. TWIST

Złączka prosta niklowana z oringiem (wersja długa), śrubunek

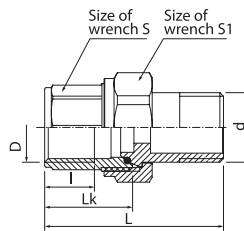

DN	Kod	Wymiary										P nom. / max temp.	Ilość szt.	Opakow.	Waga netto	Kod	Cena
		Rozmiar	D	d	L	Lk	I	S	S1								
15	4912040	1/2"	Rp1/2	R1/2	54	26	12	24	30	PN 10 / 100°C	50	P-43	0,106	4912040	16,70 zł		
20	4913040	3/4"	Rp3/4	R3/4	60	28	14	30	37	PN 10 / 100°C	50	P-1	0,162	4913040	24,90 zł		

5. TWIST

Złączka prosta śrutowana (wersja krótka), śrubunek

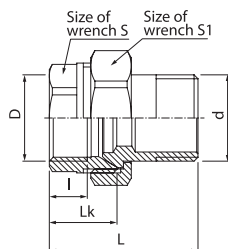

DN	Kod	Wymiary										P nom. / max temp.	Ilość szt.	Opakow.	Waga netto	Kod	Cena
		Rozmiar	D	d	L	Lk	I	S	S1								
15	4912500	1/2"	Rp1/2	R1/2	48	17	12	24	30	PN 10 / 100°C	50	P-43	0,088	4912500	13,05 zł		
20	4913500	3/4"	Rp3/4	R3/4	52	21	15	34	37	PN 10 / 100°C	70	P-1	0,134	4913500	19,40 zł		
25	4914500	1"	Rp1	R1	61	24	17	42	46	PN 10 / 100°C	30/5	P-1 / foil bag	0,270	4914500	39,10 zł		
32	4915500	1 1/4"	Rp1 1/4	R1 1/4	65.5	25.5	17	47	54	PN 10 / 100°C	20/5	P-1 / foil bag	0,409	4915500	60,10 zł		
40	4916500	1 1/2"	Rp1 1/2	R1 1/2	67	27	19	58	65	PN 10 / 100°C	15/5	P-1 / foil bag	0,577	4916500	86,40 zł		
50	4917500	2"	Rp2	R2	77	31	22	70	76	PN 10 / 100°C	8	P-1 / foil bag	1,027	4917500	167,00 zł		

6. TWIST

Złączka prosta śrutowana z oringiem (wersja krótka), śrubunek

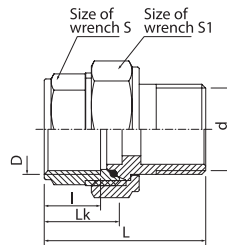

DN	Kod	Wymiary									P nom. / max temp.	Ilość szt.	Opakow.	Waga netto	Kod	Cena
		Rozmiar	D	d	L	Lk	l	S	S1							
15	4912050	1/2"	Rp1/2	R1/2	43	19	12	24	30	PN 10 / 100°C	50	P-43	0,085	4912050	12,05 zł	
20	9024040	3/4"	Rp3/4	R3/4	49	22	14	32	38	PN 10 / 100°C	60	P-1	0,166	9024040	17,90 zł	
25	9024060	1"	Rp1	R1	54	24	16	40	46	PN 10 / 100°C	30	P-1	0,273	9024060	31,70 zł	
32	9024080	1 1/4"	Rp1 1/4	R1 1/4	65.5	30	23	52	56	PN 10 / 100°C	24	P-1	0,388	9024080	64,70 zł	
40	9024100	1 1/2"	Rp1 1/2	R1 1/2	67	31	23	58	64	PN 10 / 100°C	15	P-1	0,615	9024100	86,60 zł	
50	9024120	2"	Rp2	R2	77	36.5	27.5	70	76	PN 10 / 100°C	6	P-1	1,131	9024120	180,50 zł	

7. TWIST

Złączka kolankowa śrutowana, śrubunek

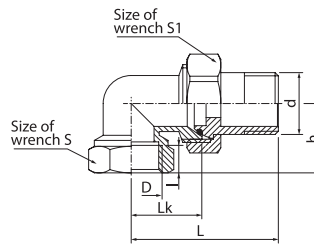

DN	Kod	Wymiary									P nom. / max temp.	Ilość szt.	Opakow.	Waga netto	Kod	Cena
		Rozmiar	D	d	L	Lk	H	S	S1							
10	4916010	3/8"	Rp3/8	R3/8	52	26	10	25	22	27	PN 10 / 100°C	50	P-43	0,119	4916010	16,60 zł
15	4917010	1/2"	Rp1/2	R1/2	56.5	29.5	15	33	27	30	PN 10 / 100°C	30	P-43	0,165	4917010	22,50 zł
20	4918010	3/4"	Rp3/4	R3/4	61	32.5	16.5	37	30	37	PN 10 / 100°C	30	P-1	0,251	4918010	34,30 zł
25	4919010	1"	Rp1	R1	69.5	36.5	19.5	46.5	37	46	PN 10 / 100°C	20	P-1	0,400	4919010	52,20 zł

8. TWIST

Złączka kolankowa śrutowana z oringiem, śrubunek

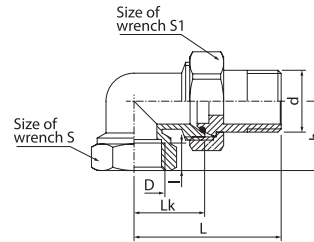

DN	Kod	Wymiary									P nom. / max temp.	Ilość szt.	Opakow.	Waga netto	Kod	Cena
		Rozmiar	D	d	L	Lk	H	S	S1							
15	4917030	1/2"	Rp1/2	R3/8	60	31	12	28	25	30	PN 10 / 100°C	30	P-43	0,131	4917030	19,65 zł
20	4918030	3/4"	Rp3/4	R3/4	66	34	14	30	32	37	PN 10 / 100°C	40	P-1	0,215	4918030	28,00 zł
25	4919030	1"	Rp1	R1	72	37	16	35	38	46	PN 10 / 100°C	20	P-1	0,331	4919030	44,50 zł
32	9024200	1 1/4"	Rp1 1/4	R1 1/4	79	44	21.5	51	47	56	PN 10 / 100°C	15	P-1	0,511	9024200	70,00 zł
40	9024220	1 1/2"	Rp1 1/2	G1 1/2	86	50	21.5	56.5	54	64	PN 10 / 100°C	8	P-1	0,882	9024220	119,80 zł
50	9024240	2"	Rp2	R2	103	63	25.5	69	66	76	PN 10 / 100°C	4	P-1	1,717	9024240	251,00 zł

9. TWIST

Przedłużacz śrutowany 15M

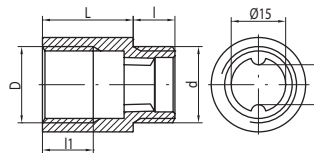

DN	Kod	Version	Wymiary					P nom. / max temp.	Ilość szt.	Opakow.	Waga netto	Kod	Cena
			D	d	L	l	l1						
15	0200160	15M-L10	G1/2	G1/2	10	10	8.5	PN 10 / 100°C	100/10	P-43/foil bag	0,028	0200160	3,50 zł
15	0200120	15M-L15	G1/2	G1/2	15	11.5	10.5	PN 10 / 100°C	100	P-43	0,041	0200120	4,90 zł
15	0200110	15M-L20	G1/2	G1/2	20	11.5	14	PN 10 / 100°C	100	P-43	0,054	0200110	5,90 zł
15	0200100	15M-L25	G1/2	G1/2	25	11.5	14	PN 10 / 100°C	90	P-43	0,065	0200100	6,90 zł
15	0200090	15M-L30	G1/2	G1/2	30	11.5	14	PN 10 / 100°C	70	P-43	0,054	0200090	8,35 zł
15	0200080	15M-L35	G1/2	G1/2	35	11.5	14	PN 10 / 100°C	60	P-43	0,098	0200080	9,10 zł
15	0200070	15M-L40	G1/2	G1/2	40	11.5	14	PN 10 / 100°C	60	P-43	0,112	0200070	10,00 zł
15	0200060	15M-L50	G1/2	G1/2	50	11.5	14	PN 10 / 100°C	50	P-43	0,140	0200060	12,05 zł
15	0200050	15M-L60	G1/2	G1/2	60	11.5	14	PN 10 / 100°C	40	P-43	0,160	0200050	13,05 zł

10. TWIST

Przedłużacz śrutowany 20M

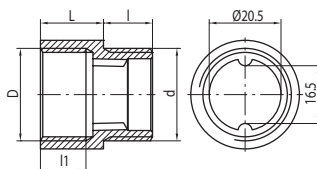

DN	Kod	Version	Wymiary					P nom. / max temp.	Ilość szt.	Opakow.	Waga netto	Kod	Cena
			D	d	L	l	l1						
20	0200130	20M-L20	G3/4	G3/4	20	12	15	PN 10 / 100°C	70/10	P-43 / foil bag	0,061	0200130	7,65 zł

11. TWIST

Kolanko nakrętno śrutowane

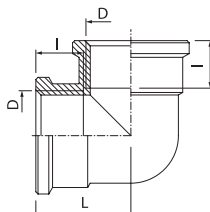

Kod	Rozmiar	Wymiary					P nom. / max temp.	Ilość szt.	Opakow.	Waga netto	Kod	Cena
		D	L	l	l1	H						
6041380	3/8"	G3/8	22,5	10		PN 10 / 100°C	100/10	P-43 / foil bag	0,035	6041380	5,35 zł	
6042380	1/2"	G1/2	25	12		PN 10 / 100°C	50	P-43	0,079	6042380	9,65 zł	
6043380	3/4"	G3/4	27,5	13,5		PN 10 / 100°C	30	P-43	0,123	6043380	14,05 zł	
6044380	1"	G1	33	16		PN 10 / 100°C	30	P-1	0,216	6044380	23,30 zł	
6045380	1 1/4"	G1 1/4	41,5	18,5		PN 10 / 100°C	25/5	P-1 / foil bag	0,201	6045380	32,20 zł	

12. TWIST

Kolanko nakrętno-wkrętno śrutowane

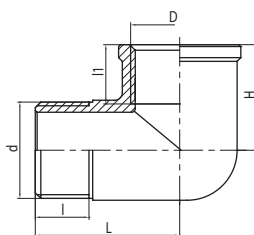

Kod	Rozmiar	Wymiary							P nom. / max temp.	Ilość szt.	Opakow.	Waga netto	Kod	Cena
		D	d	l	l1	H	H	H						
6041100	3/8"	G3/8	G3/8	27	10,5	10,5	18	PN 10 / 100°C	100/10	P-43 / foil bag	0,035	6041100	5,35 zł	
6042100	1/2"	G1/2	G1/2	33	13	14	24	PN 10 / 100°C	60/10	P-43 / foil bag	0,078	6042100	9,75 zł	
6043100	3/4"	G3/4	G3/4	39	14,5	16	28,5	PN 10 / 100°C	60/10	P-43 / foil bag	0,123	6043100	14,15 zł	
6044100	1"	G1	G1	44	17	18	33	PN 10 / 100°C	40/5	P-43 / foil bag	0,197	6044100	23,80 zł	

13. TWIST

Trójnik nakrętny śrutowany

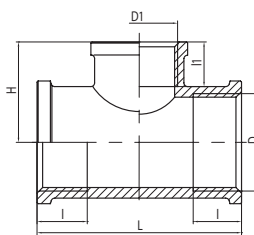

Kod	Rozmiar	Wymiary					P nom. / max temp.	Ilość szt.	Opakow.	Waga netto	Kod	Cena
		D	H	L	l	l1						
6051420	3/8"	G3/8	22,5	45	10	PN 10 / 100°C	70/10	P-43 / foil bag	0,043	6051420	6,90 zł	
6052420	1/2"	G1/2	23,5	47	12	PN 10 / 100°C	40	P-43	0,104	6052420	11,10 zł	
6053420	3/4"	G3/4	27,5	55	13,5	PN 10 / 100°C	25	P-43	0,168	6053420	18,40 zł	
6054420	1"	G1	32	64	15	PN 10 / 100°C	30	P-1	0,276	6054420	29,50 zł	

14. TWIST

Trójnik nakrętny niklowany

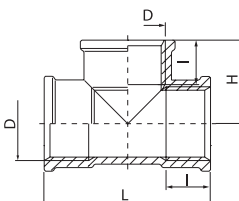

Kod	Rozmiar	Wymiary					P nom. / max temp.	Ilość szt.	Opakow.	Waga netto	Kod	Cena
		D	H	L	l	l1						
6052430	1/2"	G1/2	23,5	47	12	PN 10 / 100°C	40	P-43	0,104	6052430	12,75 zł	
6053430	3/4"	G3/4	27,5	55	13,5	PN 10 / 100°C	25	P-43	0,168	6053430	18,80 zł	
6054430	1"	G1	32	64	15	PN 10 / 100°C	30	P-1	0,276	6054430	28,00 zł	

15. **TWIST**
Trójnik nakrętny śrutowany

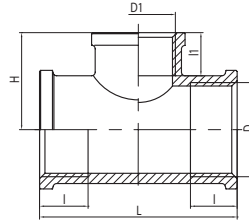

Kod	Version	Wymiary						P nom. / max temp.	Ilość szt.	Opakow.	Waga netto	Kod	Cena
		D	D1	L	l	l1	H						
6052100	3/4"-1/2"-3/4"	G3/4	G1/2	55	13.5	12	27	PN 10 / 100°C	20/10	P-43 / foil bag	0,099	6052100	14,60 zł
6053100	1"-1/2"-1"	G1	G1/2	55	15	12	32	PN 10 / 100°C	15/5	P-43 / foil bag	0,127	6053100	20,80 zł
6054100	1"-3/4"-1"	G1	G3/4	56	15	13.5	32	PN 10 / 100°C	15/5	P-43 / foil bag	0,140	6054100	23,00 zł

16. **TWIST**
Złączka nakrętna śrutowana - mufa

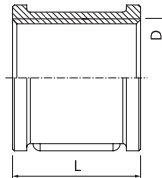

Kod	Rozmiar	Wymiary		P nom. / max temp.	Ilość szt.	Opakow.	Waga netto	Kod	Cena
		D	L						
6031100	3/8"	G3/8	24	PN 10 / 100°C	100/10	P-43 / foil bag	0,027	6031100	4,35 zł
6032100	1/2"	G1/2	27	PN 10 / 100°C	70/10	P-43 / foil bag	0,046	6032100	6,25 zł
6033100	3/4"	G3/4	30	PN 10 / 100°C	40/10	P-43 / foil bag	0,067	6033100	9,10 zł
6034100	1"	G1	33	PN 10 / 100°C	30/10	P-43 / foil bag	0,095	6034100	12,80 zł
6035100	1 1/4"	G1 1/4	38	PN 10 / 100°C	10/5	P-43 / foil bag	0,142	6035100	21,50 zł

17. **TWIST**
Złączka nakrętna redukcyjna śrutowana

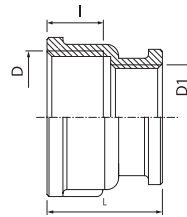

Kod	Version	Wymiary				P nom. / max temp.	Ilość szt.	Opakow.	Waga netto	Kod	Cena
		D	D1	L	l						
6031030	1/2"-3/8"	G1/2	G3/8	27	14	PN 10 / 100°C	100/10	P-43 / foil bag	0,029	6031030	4,90 zł
6032030	3/4"-1/2"	G3/4	G1/2	27,5	14,5	PN 10 / 100°C	60/10	P-43 / foil bag	0,056	6032030	7,90 zł
6033030	1"-1/2"	G1	G1/2	31	16,5	PN 10 / 100°C	60/5	P-43 / foil bag	0,068	6033030	10,40 zł
6034030	1"-3/4"	G1	G3/4	32	16,5	PN 10 / 100°C	40/5	P-43 / foil bag	0,071	6034030	10,50 zł

18. **TWIST**
Złączka wkrętna śrutowana - nypel

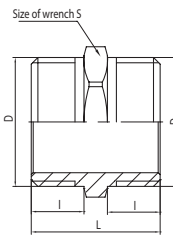

Kod	Rozmiar	Wymiary					P nom. / max temp.	Ilość szt.	Opakow.	Waga netto	Kod	Cena
		d	L	L	S	d1						
6031150	3/8"	G3/8	22,5	9	17	PN 10 / 100°C	250/10	P-43 / foil bag	0,020	6031150	2,95 zł	
6032150	1/2"	G1/2	26,5	10,5	21	PN 10 / 100°C	130/10	P-43 / foil bag	0,031	6032150	4,60 zł	
6033150	3/4"	G3/4	29	11,5	27	PN 10 / 100°C	70/10	P-43 / foil bag	0,043	6033150	6,55 zł	
6034150	1"	G1	33	13,5	34	PN 10 / 100°C	40/5	P-43 / foil bag	0,067	6034150	10,60 zł	
6035150	1 1/4"	G1 1/4	36	14,5	43	PN 10 / 100°C	50/5	P-1 / foil bag	0,103	6035150	17,00 zł	
6036150	1 1/2"	G1 1/2	41	16,5	49	PN 10 / 100°C	40/5	P-1 / foil bag	0,140	6036150	22,90 zł	

19. **TWIST**
Złączka wkrętna redukcyjna śrutowana

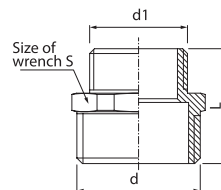

Kod	Version	Wymiary				P nom. / max temp.	Ilość szt.	Opakow.	Waga netto	Kod	Cena
		d	d1	L	S						
6031060	1/2"-3/8"	G1/2	G3/8	26	21	PN 10 / 100°C	150/10	P-43 / foil bag	0,024	6031060	3,95 zł
6032060	1/2"-3/4"	G3/4	G1/2	28,5	27	PN 10 / 100°C	80/10	P-43 / foil bag	0,038	6032060	6,35 zł
6033060	1/2"-1"	G1/2	G1/2	33	34	PN 10 / 100°C	100/5	P-1 / foil bag	0,055	6033060	9,85 zł
6034060	3/4"-1"	G1	G3/4	34	34	PN 10 / 100°C	100/5	P-1 / foil bag	0,061	6034060	10,30 zł

20. TWIST

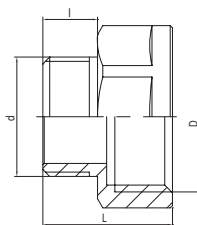
Złączka nakrętno-wkrętna
redukcyjna śrutowana

Kod	Version	Wymiary					P nom. / max temp.	Ilość szt.	Opakow.	Waga netto	Kod	Cena
		D	d	L	l	S						
6031010	3/8"-1/2"	G1/2	G3/8	25.5	10.5	24	PN 10 / 100°C	120/10	P-43 / foil bag	0,033	6031010	4,70 zł
6032010	1/2"-3/8"	G3/8	G1/2	21.5	12	21	PN 10 / 100°C	150/10	P-43 / foil bag	0,027	6032010	4,35 zł
6033010	1/2"-3/4"	G3/4	G1/2	24.5	10.5	30	PN 10 / 100°C	80/10	P-43 / foil bag	0,051	6033010	7,65 zł
6035010	3/4"-1/2"	G1/2	G3/4	25	13	27	PN 10 / 100°C	80/10	P-43 / foil bag	0,041	6035010	6,55 zł
6036010	3/4"-1"	G1	G3/4	28.5	12	36	PN 10 / 100°C	40/10	P-43 / foil bag	0,080	6036010	11,85 zł
6037010	1"-3/4"	G3/4	G1	27	14	34	PN 10 / 100°C	40/5	P-43 / foil bag	0,075	6037010	11,65 zł

21. TWIST

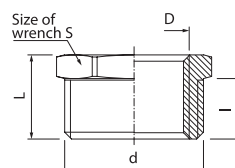
Złączka nakrętno-wkrętna
redukcyjna śrutowana

Kod	Version	Wymiary					P nom. / max temp.	Ilość szt.	Opakow.	Waga netto	Kod	Cena
		D	d	L	l	S						
6032500	3/8"-1/2"	G3/8	G1/2	17	12	21	PN 10 / 100°C	200/10	P-43 / foil bag	0,014	6032500	2,60 zł
6033500	1/2"-3/4"	G1/2	G3/4	18	12.5	27	PN 10 / 100°C	150/10	P-43 / foil bag	0,026	6033500	4,50 zł
6034500	1/2"-1"	G1/2	G1	21.5	15	34	PN 10 / 100°C	70/5	P-43 / foil bag	0,061	6034500	9,10 zł
6035500	3/4"-1"	G3/4	G1	21.5	15	34	PN 10 / 100°C	70/5	P-43 / foil bag	0,044	6035500	7,90 zł

22. TWIST

Złączka do wodomierza

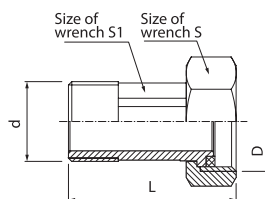

Kod	Rozmiar	Wymiary					P nom. / max temp.	Ilość szt.	Opakow.	Waga netto	Kod	Cena
		D	d	L	S	S1						
6032120	1/2"	G3/4	G1/2	45	29	19	PN 10 / 100°C	100/10	P-1 / foil bag	0,078	6032120	10,20 zł
6033120	3/4"	G1	G3/4	48	37	24	PN 10 / 100°C	60/10	P-1 / foil bag	0,131	6033120	17,40 zł
6034120	1"	G1 1/4	G1	53.5	46	30	PN 10 / 100°C	30/5	P-1 / foil bag	0,213	6034120	28,90 zł

23. TWIST

Zaslepka nakrętna śrutowana

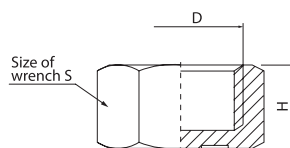

Kod	Rozmiar	Wymiary			P nom. / max temp.	Ilość szt.	Opakow.	Waga netto	Kod	Cena
		D	H	S						
6095200	3/8"	G3/8	11	20	20	300/10	P-43 / foil bag	0,015	6095200	2,05 zł
6095220	1/2"	G1/2	12	24	24	200/10	P-43 / foil bag	0,023	6095220	4,25 zł
6095230	3/4"	G3/4	12	30	30	100/10	P-43 / foil bag	0,037	6095230	6,00 zł
6095240	1"	G1	13	37	37	70/5	P-43 / foil bag	0,059	6095240	7,80 zł

24. TWIST

Zaslepka nakrętna niklowana

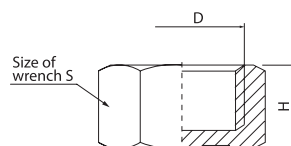

Kod	Rozmiar	Wymiary			P nom. / max temp.	Ilość szt.	Opakow.	Waga netto	Kod	Cena
		D	H	S						
6095250	1/2"	G1/2	12	24	PN 10 / 100°C	200/10	P-43 / foil bag	0,023	6095250	4,80 zł
6095260	3/4"	G3/4	12	30	PN 10 / 100°C	100/10	P-43 / foil bag	0,037	6095260	6,90 zł
6095270	1"	G1	13	37	PN 10 / 100°C	70/5	P-43 / foil bag	0,059	6095270	8,55 zł

25. TWIST

Korek z kołnierzem
śrutowany

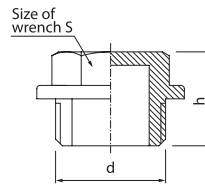

Kod	Rozmiar	Wymiary			P nom. / max temp.	Ilość szt.	Opakow.	Waga netto	Kod	Cena
		d	H	S						
6095380	3/8"	G3/8	15	12	PN 10 / 100°C	250/10	P-43 / foil bag	0,015	6095380	2,05 zł
6095350	1/2"	G1/2	17	14	PN 10 / 100°C	500/50	P-1 / wor. 22x25	0,029	6095350	4,25 zł
6095360	3/4"	G3/4	19	17	PN 10 / 100°C	200/50	P-1 / wor. 22x25	0,050	6095360	6,70 zł
6095370	1"	G1	21	27	PN 10 / 100°C	100/25	P-1 / wor. 22x25	0,098	6095370	10,10 zł

26. TWIST

Korek z kołnierzem,
niklowany

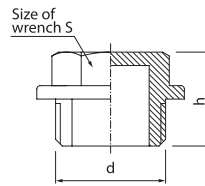

Kod	Rozmiar	Wymiary			P nom. / max temp.	Ilość szt.	Opakow.	Waga netto	Kod	Cena
		d	H	S						
6095450	1/2"	G1/2	17	14	PN 10 / 100°C	500/50	P-1 / wor. 22x25	0,029	6095450	4,50 zł
6095460	3/4"	G3/4	19	17	PN 10 / 100°C	200/50	P-1 / wor. 22x25	0,050	6095460	7,10 zł
6095470	1"	G1	21	27	PN 10 / 100°C	100/25	P-1 / wor. 22x25	0,098	6095470	11,60 zł



1. V-PEX
Przyłączka prosta śrutowana

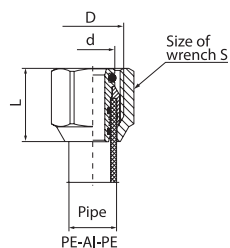

Kod	Wersja	Wymiary				P nom.	Ilość szt.	Opakow.	Waga netto	Kod	Cena
		D	d	L	S						
6007050	12-16 G1/2	G1/2	14	23	24	PN 10	140/20	P-1 / foil bag 22x25	0,050	6007050	10,40 zł
6008050	16-20 G3/4	G3/4	20	28	30	PN 10	90/15	P-1 / foil bag 22x25	0,084	6008050	16,20 zł

2. V-PEX
Przyłączka prosta niklowana

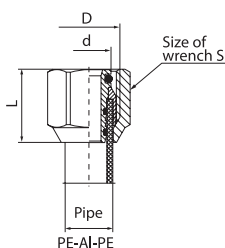

Kod	Wersja	Wymiary				P nom.	Ilość szt.	Opakow.	Waga netto	Kod	Cena
		D	d	L	S						
6007060	12-16 G1/2	G1/2	14	23	24	PN 10	140/20	P-1 / foil bag 22x25	0,050	6007060	11,40 zł
6008040	16-20 G3/4	G3/4	20	28	30	PN 10	90/15	P-1 / foil bag 22x25	0,084	6008040	17,70 zł

3. V-PEX
Przyłączka prosta niklowana

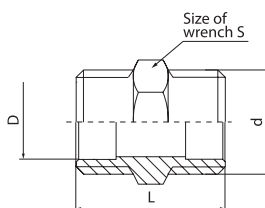

Kod	Wymiar	Wymiary				P nom.	Ilość szt.	Opakow.	Waga netto	Kod	Cena
		D	d	L	S						
6032220	1/2"	14,45	G1/2	29	22	PN 10	150	P-43	0,041	6032220	5,05 zł
6033220	3/4"	20,3	G3/4	36	27	PN 10	80	P-43	0,063	6033220	9,00 zł
6034220	1"	25	G1	38	34	PN 10	40	P-43	0,108	6034220	14,05 zł

4. V-PEX
Przyłączka prosta niklowana

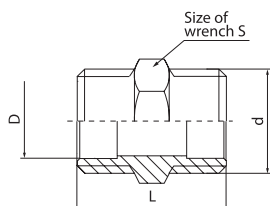

Kod	Wymiar	Wymiary				P nom.	Ilość szt.	Opakow.	Waga netto	Kod	Cena
		D	d	L	S						
6032240	1/2"	14,45	G1/2	29	22	PN 10	150	P-43	0,041	6032240	5,80 zł
6033240	3/4"	20,3	G3/4	36	27	PN 10	80	P-43	0,063	6033240	10,95 zł
6034240	1"	25	G1	38	34	PN 10	40	P-43	0,108	6034240	16,35 zł

5. V-PEX
Złączka wkrętna redukcyjna śrutowana

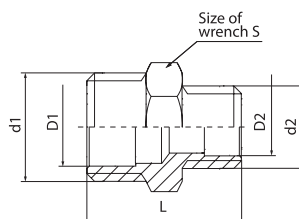

Kod	Wersja	Wymiary						P nom.	Ilość szt.	Opakow.	Waga netto	Kod	Cena
		d1	D1	d2	D2	L	S						
6032410	3/8"-1/2"	G1/2	14,45	G3/8	11	27,5	22	PN 10	150	P-43	0,034	6032410	5,35 zł
6033420	1/2"-3/4"	G3/4	20,3	G1/2	14,45	33,5	27	PN 10	80	P-43	0,058	6033420	9,30 zł
6034420	3/4"-1"	G1	25	G3/4	20,3	37	34	PN 10	50	P-43	0,093	6034420	12,75 zł

6. V-PEX
Złączka nakrętno-wkrętna
redukcyjna śrutowana

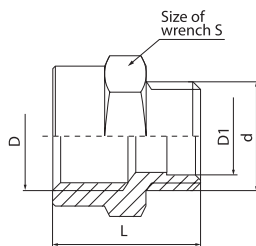

Kod	Wersja	Wymiary					P nom.	Ilość szt.	Opakow.	Waga netto	Kod	Cena
		D	d	D1	L	S						
6037520	1/2"-3/4"	G1/2	G3/4	20,3	32	27	PN 10	100	P-43	0,062	6037520	8,75 zł
6038520	3/4"-1"	G3/4	G1	25	35	34	PN 10	50	P-43	0,107	6038520	13,80 zł

7. V-PEX
Złączka nakrętna śrutowana

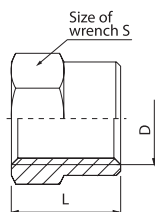

Kod	Wymiar	Wymiary			P nom.	Ilość szt.	Opakow.	Waga netto	Kod	Cena
		D	L	S						
6037110	1/2"	G1/2	25	26	PN 10	100	P-43	0,046	6037110	7,35 zł
6038110	3/4"	G3/4	28	32	PN 10	60	P-43	0,063	6038110	8,00 zł
6039110	1"	G1	31	40	PN 10	40	P-43	0,115	6039110	14,50 zł

8. V-PEX
Kolanko wkrętne śrutowane

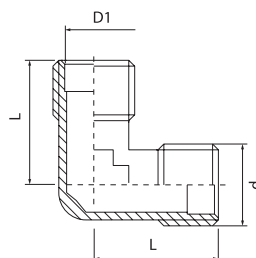

Kod	Wymiar	Wymiary			P nom.	Ilość szt.	Opakow.	Waga netto	Kod	Cena
		D	D1	L						
6042320	1/2"	G1/2	14,45	25	PN 10	80	P-43	0,049	6042320	9,00 zł
6043320	3/4"	G3/4	20,3	30	PN 10	40	P-43	0,117	6043320	15,50 zł

9. V-PEX
Kolanko nakrętno-wkrętne śrutowane

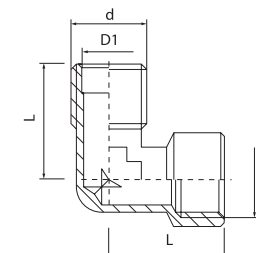

Kod	Wymiar	Wymiary				P nom.	Ilość szt.	Opakow.	Waga netto	Kod	Cena
		D	d	D1	L						
6042420	1/2"	Rp1/2	R1/2	14,45	32	PN 10	50	P-43	0,071	6042420	9,65 zł
6043420	3/4"	Rp3/4	R3/4	20,3	35	PN 10	30	P-43	0,148	6043420	16,35 zł
6044420	1"	Rp1	R1	25	40	PN 10	40	P-1	0,178	6044420	22,40 zł

10. V-PEX
Kolanko nakrętno-wkrętne
niklowane

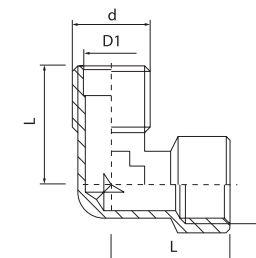

Kod	Wymiar	Wymiary				P nom.	Ilość szt.	Opakow.	Waga netto	Kod	Cena
		D	d	D1	L						
6042400	1/2"	Rp1/2	R1/2	14,45	32	PN 10	50	P-43	0,071	6042400	11,95 zł
6043400	3/4"	Rp3/4	R3/4	20,3	35	PN 10	30	P-43	0,148	6043400	19,20 zł

11. V-PEX
Trójnik wkrętny śrutowany

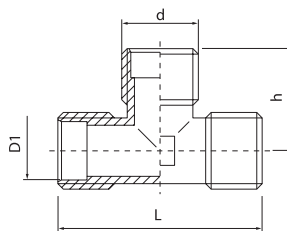

Kod	Wymiar	Wymiary				P nom.	Ilość szt.	Opakow.	Waga netto	Kod	Cena
		d	D1	L	h						
6052320	1/2"	G1/2	14,45	51	25	PN 10	50	P-43	0,064	6052320	10,00 zł
6053320	3/4"	G3/4	20,3	60	30	PN 10	30	P-43	0,105	6053320	16,70 zł

12. V-PEX
Kołanko ustalone śrutowane

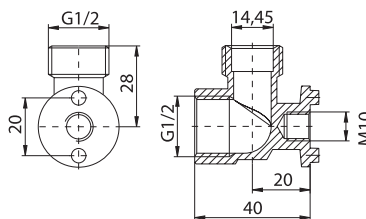

Kod	Wymiar	P nom.	Ilość szt.	Opakow.	Waga netto	Kod	Cena
6022330	1/2"	PN 10	50	P-43	0,096	6022330	12,05 zł

13. V-PEX
Złączka wkrętna redukcyjna śrutowana

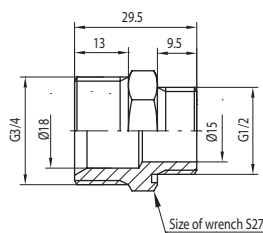

Kod	Wersja	P nom.	Ilość szt.	Opakow.	Waga netto	Kod	Cena
6033440	1/2"-3/4"	PN 10	80	P-43	0,056	6033440	8,55 zł

NASI DOSTAWCY MATERIAŁÓW I CZĘŚCI

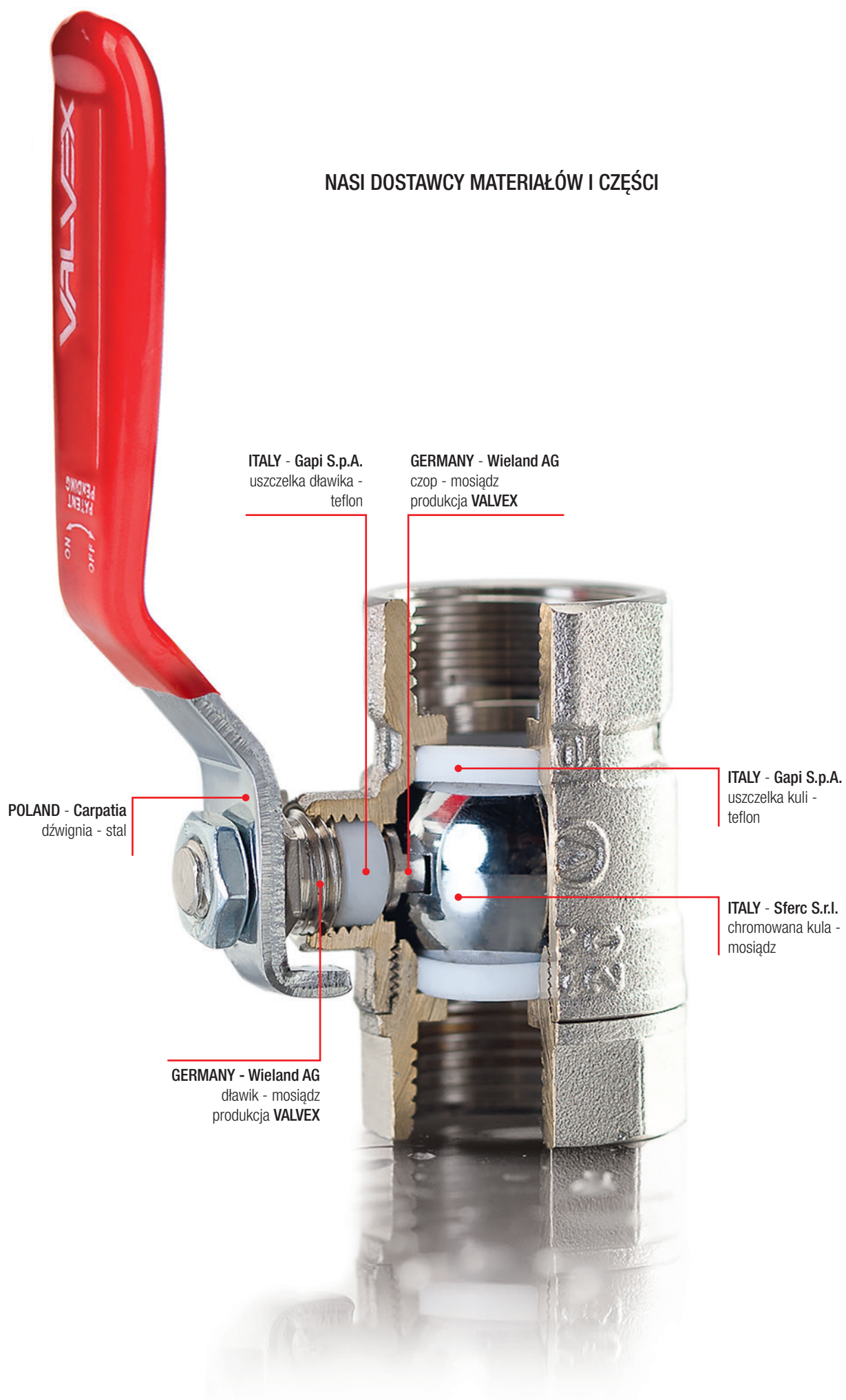

OGÓLNE WARUNKI SPRZEDAŻY

Dostawy wyrobów firmy VALVEX odbywają się zgodnie z zasadami i warunkami umów handlowych zawartych z kontrahentami, ogólnymi warunkami sprzedaży zawartymi w niniejszym dokumencie oraz na podstawie cen katalogowych netto obowiązujących w dniu złożenia zamówienia.

Do cen zawartych w aktualnym cenniku VALVEX należy doliczyć VAT wg aktualnie obowiązującej stawki.

Modyfikacje zasad i warunków dostaw są obowiązujące tylko i wyłącznie, jeżeli zostały zaakceptowane przez VALVEX w formie pisemnej.

Zamówienia na wszystkie wyroby muszą być składane w formie pisemnej (dopuszczalne są również fax i e-mail). Wyroby z przeznaczeniem na ekspozycję należy zamawiać oddzielnie. Błędy zamówienia obciążają Zamawiającego.

Wszystkie wyroby VALVEX są zapakowane fabrycznie w sposób zapewniający bezpieczny transport przeznaczonymi do tego celu środkami transportu.

Odbiorca odbierający towar własnym transportem jest zobowiązany sprawdzić przy załadunku, czy dostawa jest zgodna z fakturą i dokumentem WZ, czy opakowania nie są uszkodzone oraz ma prawo sprawdzenia kompletności wyrobów w poszczególnych opakowaniach. Jeżeli Odbiorca nie zgłosi zastrzeżeń co do kompletności dostawy, stanu opakowań i sposobu załadunku przed opuszczeniem terenu VALVEX, dostawę, opakowania i załadunek uważa się za prawidłowe. W tym przypadku ryzyko uszkodzenia lub utraty towaru przechodzi na Kupującego.

Jeżeli dostawa odbywa się transportem VALVEX lub firmą spedycyjną (kurierską), Odbiorca zobowiązany jest zgłosić naruszenie lub uszkodzenie przesyłki (np: zerwanie folii zabezpieczającej, taśmy z logiem VALVEX lub taśmy OCHRONA) lub ewentualne zastrzeżenia do stanu opakowań dostarczonych wyrobów i zgodności dostawy z fakturą i dokumentem WZ, kierowcy przewoźnika, w formie pisemnej przy odbiorze towaru. Jeżeli nie wniesiono pisemnych zastrzeżeń, wyroby uważa się za dostarczone w nieuszkodzonych opakowaniach, zgodnie z fakturą i dokumentem WZ, a ryzyko uszkodzenia lub utraty towaru przechodzi z tą chwilą na Kupującego. Odbiorca zobowiązany jest do zapewnienia odpowiednich sił i środków gwarantujących sprawny rozładunek wyrobów dostarczonych transportem VALVEX.

VALVEX w żadnym przypadku nie ponosi odpowiedzialności za uszkodzenia i straty powstałe w wyniku nieodpowiedniego transportu przez Odbiorcę lub firmę przez niego wynajętą oraz wynikające z zaistnienia tzw. siły wyższej. O stwierdzonych brakach ilościowych w opakowaniach należy powiadomić VALVEX nie później niż 14 dni roboczych od otrzymania dostawy zarówno w przypadku wysyłek spedycyjnych, jak i wysyłki transportem Valvex. Zgłoszenie reklamacji ilościowej winno być wystawione na papierze firmowym (lub opatrzone pieczętką nagłówkową firmy reklamującej), zawierać krótką informację o liczbie sztuk wyrobów brakujących, z każdego opakowania oddzielnie, wraz z podaniem stanu technicznego opakowania (uszkodzone, dziurawe, otwarte, niezaplombowane, bez metki itp.), nr katalogowy, nr faktury zakupowej, datę i miejsce stwierdzenia niezgodności. Metki z każdego opakowania, w którym stwierdzono niedobór, wraz ze zgłoszeniem Odbiorca wysłać na adres VALVEX listem poleconym po uprzednim zgłoszeniu faxem lub e-mailem. VALVEX po ewentualnym uznaniu reklamacji wystawi fakturę korygującą lub jeżeli jest to możliwe, uzupełni niedobór w sposób fizyczny. VALVEX przyjmuje obowiązek załatwienia reklamacji ilościowej w ciągu 30 dni.

Wszelkie reklamacje ilościowe strony trzeciej są wykluczone.

VALVEX udziela Użytkownikom na swe wyroby następującej gwarancji – licząc od daty sprzedaży*:

– 25 lat na baterie, kurki kulowe, zawory wypływowe i zawory przelotowe, zawory i kurki kątowe, reduktory ciśnienia, głowice i zawory termostatyczne, zawory grzejnikowe oraz zespoły odcinające, dwuzłączki i filtry, na kurki kulowe MINI, pozostały asortyment armatury instalacyjnej wodnej oraz na filtry, automatyczne zawory odpowietrzające oraz pozostały asortyment armatury do centralnego ogrzewania;

– 5 lat na szybkozłącze i przewody elastyczne do gazu;

– 2 lata na szafki do rozdzielaczy C.O.

W żadnym wypadku gwarancją nie są objęte elementy zużywające się w czasie eksploatacji i pozostały asortyment nieopisany powyżej.

W trakcie promocji okresy gwarancyjne mogą ulec zmianie, co zostanie potwierdzone w odpowiednich dokumentach gwarancyjnych.

VALVEX będzie, według swego wyboru, wymieniać lub naprawiać wyroby lub ich części, które w okresie trwania gwarancji, licząc od dnia przeniesienia odpowiedzialności, stały się bezużyteczne, lub których użyteczność została znacznie ograniczona na skutek okoliczności pochodzącej sprzed momentu przeniesienia odpowiedzialności, obciążającej VALVEX, a w szczególności na skutek wadliwej konstrukcji, wad materiałowych lub wadliwego wykonania. Wymienione wadliwe wyroby lub ich części pozostają własnością VALVEX. Wybór sposobu wykonania gwarancji należy do VALVEX.

Odpowiedzialność za wady z tytułu gwarancji nie obejmuje naturalnego zużycia oraz wad, których przyczyną nie są zależne od VALVEX (użytkowanie niezgodne z przeznaczeniem, błąd projektowy instalacji, praca powyżej parametrów dopuszczalnych, uszkodzenia mechaniczne, uszkodzenia spowodowane brakiem lub nieodpowiednią konserwacją i dbałością o czystość wyrobu, uszkodzenia spowodowane montażem niezgodnym z instrukcją, uszkodzeń spowodowanych działaniem tzw. siły wyższej oraz wynikających z naturalnego zużycia elementów wyrobu). Samodzielne usuwanie wad przez Zamawiającego / Użytkownika dopuszczalne jest tylko w przypadkach wyjątkowych (np. zagrożenie bezpieczeństwa). W przypadkach takich należy niezwłocznie informować VALVEX.

Decyzją o uznaniu roszczeń z tytułu wad i braków podejmowana jest przez służby kontroli jakości VALVEX. Kupujący obowiązany jest umożliwić VALVEX usunięcie wad w sposób wskazany powyżej. Jeżeli tego odmawia, VALVEX zwolniony jest z obowiązku usunięcia wad. Żądania wykraczające poza opisany zakres są wykluczone. Wyklucza się również zmiany w samej umowie kupna-sprzedaży, takie jak obniżenie ceny, wypowiedzenie umowy lub wycofanie się z niej.

Wszelkie reklamacje jakościowe winny być składane w formie pisemnej. Zgłoszenie reklamacyjne musi zawierać dane użytkownika, dokładny opis identyfikujący wyrób oraz zgłoszoną usterkę, kserokopię dokumentu potwierdzającego zakup. Dla wyrobów posiadających indywidualne karty gwarancyjne konieczne jest również przedstawienie wypełnionej i podpisanej przez sprzedającego takiej karty wraz z wpisaną czytelnie datą zakupu, zgodną z przedstawionym dokumentem zakupu.

Wszystkie wyroby VALVEX powinny być zainstalowane zgodnie z przeznaczeniem i zasadami montażu. VALVEX nie ponosi odpowiedzialności za żadne szkody wynikające z niewłaściwego montażu, a przede wszystkim spowodowane montażem uniemożliwiającym łatwy, bezkolizyjny dostęp do wyrobu.

Wyroby lub ich elementy mogą być przesłane producentowi do naprawy jedynie za jego pisemną zgodą oraz na jego koszt, tylko i wyłącznie poprzez wskazanego przez producenta przewoźnika. Przesłanie przesyłki poprzez przewoźnika innego niż wskazany przez producenta może spowodować odmowę odebrania przesyłki lub obciążenie jej kosztami nadawcy. Przesyłki muszą być odpowiednio opisanie i właściwie zapakowane, tzn. w sposób uniemożliwiający powstanie dodatkowych uszkodzeń w trakcie załadunku, transportu i rozładunku oraz spełniać podstawowe wymagania higieniczne.

VALVEX przyjmuje obowiązek zajęcia stanowiska w sprawie reklamacji jakościowej w ciągu 14 dni od otrzymania wadliwego wyrobu lub pisemnego zgłoszenia. VALVEX zastrzega sobie prawo wprowadzania zmian i ulepszeń technicznych wyrobów bez uprzedzenia.

* Pod warunkiem dochowania wymogu instalacji wyrobów do gazu produkcji Valvex przez uprawnionego instalatora.

Power of Quality

